



AGRICULTURAL

2022 Parts Catalog



TABLE OF CONTENTS

MATERIAL APPLICATION

INTELLIAG® SYSTEM

- 1 Components
- 2 Topcon X35 12" Virtual Terminal
- 3 Topcon X35 12" Virtual Terminal Harnessing
- 4 Camera and Accessories
- 5 ISO₆

INTELLIAG®/PLANTER

- 7 Planter Monitoring and Control Overview
- 8 Planter System Diagram
- 9 Planter Control Harnessing (46798-0850 and 0160)
- 10 Planter System Parts List (46798-0850 and 0160)
- 11 Planter Control Harnessing (46798-0850 and 0164)
- 12 Planter System Parts List (46798-0850 and 0164)
- 13 Row Harnesses (Adding Additional Planter Rows)
- 14 Planter System Parts List (WSMB Harnesses/Adding Rows)
- 15 Working Set Master Module and Harnesses
- 16 WSMT2 Control Channel/Accessory Inputs Harnesses
- 17 WSMB, Seed Singulation, and Accessory Modules
- 18 WSMB Harnesses
- 19 CAN to Hitch Connector and Adapter Harnesses
- 20 WSMB Implement Output Module
- 21 WSMB System Parts List
- 22 Row/Boom Switch Module
- 23 Radar Y Harnesses

INTELLIAG®/AIR CART

- 24 Air Cart Monitoring and Control Overview
- 25 Air Cart System Diagram
- 26 Air Cart Control Harnessing (46798-0161, 0852, 0201)
- 27 Air Cart System Parts List (46798-0161, 0852,0201)
- 28 Air Cart Control Harnessing (46798-0160 and 0490)
- 29 Air Cart System Parts List (46798-0160 and 0490)
- 30 Row Harnesses (Adding Additional Planter Rows)
- 31 Air Cart System Parts List (WSMB Harnesses/Adding Rows)
- 32 Working Set Master 2 (WSMT2) Module and Harnesses
- 33 WSMT2 Control Channel/Accessory Input Harnesses
- 34 WSMB Module and Harnesses
- 35 CAN to Hitch Connector and Adapter Harnesses
- 36 WSMB Implement Output Module
- 37 Cab Control Switch Module
- 38 Daisy Chain Blockage System (DCBS)
- 39 Daisy Chain Blockage System Harnessing
- 40 Daisy Chain Blockage System Typical/Alternate Installation
- 41 Radar Y Harnesses

INTELLIAG®/SPREADER

- 42 Spreader Monitoring and Control Overview
- 43 Spreader System Diagram
- 44 Spreader Control Harnessing (46798-0161)
- 45 Spreader System Parts List (46798-0161)
- 46 Working Set Master Module 2 (WSMT2) and Harnesses
- 47 CAN to Hitch Connector and Adapter Harnesses
- 48 WSMB Implement Output Module Driver
- 49 Cab Control Switch Module
- 50 Radar Y Harnesses

TABLE OF CONTENTS

INTELLIAG®/SPRAYER

- 51 Sprayer Monitoring and Control Overview
- 52 Sprayer System Diagram
- 53 Sprayer Harnessing (46798-0161)
- 54 Sprayer System Parts List (46798-0161)
- 55 Working Set Master Module 2 (WSMT2) and Harnesses
- 56 CAN to Hitch Connector and Adapter Harnesses
- 57 WSMB Implement Output Module Driver
- 58 Cab Control Switch Module
- 59 Radar Y Harnesses

INTELLIAG®/ANHYDROUS

- 61 Anhydrous System Diagram
- 62 Anhydrous Harnessing (46798-0161)
- 63 Anhydrous System Parts List (46798-0161)
- 64 Working Set Master Module 2 (WSMT2) and Harnesses
- 65 CAN to Hitch Connector and Adapter Harnesses
- 66 Radar Y Harnesses

INTELLIAG® HARNESS CONNECTOR PINOUTS

- 67 Hitch/CAN Harnesses (46798-013x, 46798-014x, 46798-036x)
- 68 Control Harness (46798-0160)
- 69 Control Harness (46798-0161)
- 70 Control Harness (46798-0162)
- 71 Control Harness (46798-0164)
- 72 Control Harness Monitor Only (46798-0165)
- 73 Accessory Harness (46798-0201)
- 74 Accessory Harness (46798-0202)
- 75 BSM/ESM Harness (46798-0330, 46798-0340)
- 76 Electric Motor Driver Power Harness (46798-0390)
- 77 Cab Harness (46798-0451A)

- 78 Power Harness (46798-0455)
- 79 Electric Motor Driver Harness (46798-0490)
- 80 WSMT T Harness (46798-0850)
- 81 WSMT T Harness (46798-0851)
- 82 WSMT T Harness (46798-0852)
- 83 Accessory Harness (46798-0860)
- 84 Accessory Harness (46798-0861)
- 85 WSMB Harness (46798-1200)
- 86 WSMB Harness (46798-1201)
- 87 12 Row Shutoff Control Harness (46798-2100)
- 88 3-Wire Boom Control Harness (46798-3100)
- 89 2-Wire Boom Control Harness (46798-3101)
- 90 2-Wire High Current Row Control Harness (46798-3501)
- 91 TruCount Air Clutch Row Control Harness (46798-3505)
- 92 2-Wire High Current Row Control Harness (46798-3508)

SENSORS/IMPLEMENT

- 93 Air Pressure/Hopper Level/Hall Effect Sensors
- 95 Application Rate Sensors
- 154 Liq Pressure/Implement Lift/Gate Height/Extension Cable

CONTROL VALVES

- 97 Liquid Control Valves
- 98 Liquid Control Valves
- 99 Liquid Boom Shutoff Valves
- 100 Valve Body without Actuator
- 101 Actuator Assemblies
- 102 Proportional Hydraulic Flow Valves
- 103 HD 4180® Control Valves
- 104 HD 4180® Calculating Flow Rate Requirements
- 105 Hydraulic Servo Valves
- 106 Hydraulic Valve Driver Module

TABLE OF CONTENTS

BLOCKAGE SYSTEMS/SENSORS

SYSTEMS

- 107 Daisy Chain Blockage System (DCBS)
- 108 Daisy Chain Blockage Typical/Alternate Installations
- 110 ASM™ II Air Seeder

SENSORS

- 111 Vigilense®/Recon Flow/Adapters

PLANTING

PLANTER MONITORS

- 112 PM100/PM300/PM332
- 113 PM400/PM500
- 114 Accessories (Row Shutoff/Sensors/Adapters/Seed Chk Alm)
- 115 Accessory Harnesses
- 116 Harnesses, Tubes, Connectors

PLANTER CHUTES/SENSORS/POPULATION

- 117 Hy Rate™/Hy Rate™ Grain Drill/Sure Rate/UniRate™
- 118 Planter Tubes and Miscellaneous Sensors

FLOW METERS

- 120 Poly/Stainless Steel/Nylon Flow Meters/Reluctance Sensor Adapter

GROUND SPEED

SENSORS/CABLES

- 121 Radar III /Radar II/Universal Speed Sensors
- 122 Radar Y Sensor Cables
- 123 Radar Y Sensor Cable Cross Reference

GRAIN ANALYSIS

MOISTURE TESTERS/ANALYZERS

- 124 GAC® 2700-AGRI Moisture Testers
- 125 GAC® 2500-UGMA/INTL Moisture Testers
- 126 GAC® 2500-AGRI Moisture Testers
- 127 GAC® 2100 Moisture Testers
- 128 GAC® 500 XT Moisture Testers

GRAIN ANALYSIS

MOISTURE TESTERS/ANALYZERS

- 129 mini GAC®/mini GAC® Plus Portable Moisture Testers
- 131 mini GAC® 2500 Portable Moisture Testers
- 132 M3G™/M20P™ Portable Moisture Testers
- 133 Instalab® 700 NIR Product Analyzers
- 134 Instalab® 700 Accessories (cups/tools)
- 135 Printer and Accessories

SOIL COMPACTION TESTING

- 136 Soil Compaction Testers

DIAGNOSTICS

TESTERS

- 137 Application Rate Sensor Tester/Seed Tester 90/
Seed Simulator/Vehicle Ground Speed Simulator
- 138 Adapters

TABLE OF CONTENTS

SERVICE PARTS

Limited Availability/Discontinued Service Parts- Call for availability.

- 140 AI-50 5"Virtual Terminal
- 141 AI-100 10"Virtual Terminal
- 142 Seed Manager® SE
- 143 Seed Manager® SE Implement Layout
- 143 PM200E/250
- 144 IntelliAg® MVT
- 145 IntelliAg® MVT Cab Harnessing
- 146 IntelliAg® MVT Implement Harnessing
- 147 IntelliAg® MVT Implement Harnessing
- 148 Land Manager® Controller I, II, and SE
- 149 Land Manager® Systems
- 150 LM1 and LM2 Kits
- 151 LMSE/Pressure/Flow/NH3 Kits
- 152 Land Manager® Parts and Accessories
- 153 Thermal Transfer Unit component parts
- 154 Hydraulic Servo
- 152 Anhydrous Monitoring and Control Overview
- 157 Poly Flow Meter Nylon Parts
- 158 Weather Pack/Amp/Metri-Pack Connectors
- 159 Weather Pack Connectors/Kits
- 160 Weather Pack Dust Cap Plugs and Receptacles
- 161 AMP Connectors/Kits

IntelliAg® : WSMTII

Components



Topcon X35

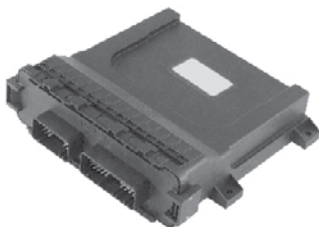

Working Set Master Module



Working Set Member Module



Tractor ECU



Master Switch

Don't forget to select a:

- Seed Sensor
- Application Rate Sensor
- Implement Lift Switch
- Ground Speed Sensor
- Boom Switch Module
- Accessory Module

IntelliAg® is a control and monitoring system for planters, sprayers, spreaders, and anhydrous applications. The system is designed to the ISO 11783 guideline to operate with any manufacturer's equipment. Modules can be added and configured to fit a variety of needs.

The system is designed to work with any ISO Universal Terminal that interfaces with specific application control modules referred to as a Working Set Master (WSMT) and Working Set Members (WSMB). The WSMT controls the application of material by interfacing with proportional hydraulic valves and feedback sensors. Optional WSMB's control inputs from sensors, valves, rows monitoring, seed singulation, and spacing quality.

Application specific versions of the WSMT are available for use with:

- Sprayers (WSMT2)
- Fertilizer spreaders
- Anhydrous bars (WSMT2)
- Planters/grain drills
- Air carts

The minimum requirements to operate an IntelliAg® system include a:

- Virtual Terminal
- Master Switch
- Working Set Master (WSMT)
- Harnesses
- Tractor ECU
- CAN Terminators
- Implement Lift Switch

Optional components include:

- Working Set Member Module
- Boom Switch Module with Planter Output Module
- Remote Test Switch

Features/Benefits:

- ISO 11783 conformance allows for one terminal for quick retrofit to tractors and implements
- Standard electrical connector at hitch for convenient plug and play installation
- Full screen alarms identify abnormal or failed operations
- Retains information when power failure occurs
- Logs 'As Applied' data
- Variable rate application capable

12" Virtual Terminal

Topcon X35



The Topcon X35 virtual terminal display is the main user interface with the IntelliAg® system and provides an all-in-one control for planting, spraying, and spreading applications. A dedicated IntelliAg® button allows quick viewing access to the IntelliAg® display and can also remain open in a mini view window on the guidance screen for viewing both applications simultaneously.

An As Applied job can be started quickly to record as applied data. Several features are available when creating an As Applied job including:

- Creating a field boundary
- Creating exclusion zones
- Creating flag points to mark field obstacles
- Creating headlands
- Using boundary offsets
- Exporting job as a .pdf to a job report

Variable rate control job data is created using a farm management software tool and is imported to the terminal via a USB memory device. Automatic rate adjustment occurs when entering different zones in the prescription map.

Key terminal features:

- Integrated auto section control
- Mini-view windows with drag-and-drop positioning
- Interaction keypads with expandable menus
- Icon-based user interface
- Dashboard readouts provide constant, convenient basic data
- Full-screen views for detailed information

Not compatible with Trimble Autopilot systems



Topcon X35 Guidance Screen

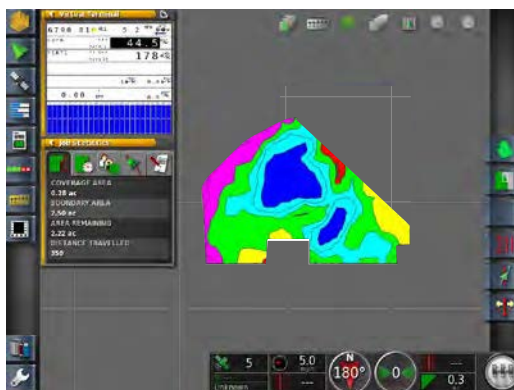

Imported Variable Rate Map

Don't forget to select a:

- Seed Sensor
- Application Rate Sensor
- Implement Lift Switch
- Ground Speed Sensor
- Row/Boom Switch Module
- Accessory Module

12" Virtual Terminal Kit	
Part Number	Description
X35CABKIT	
Kits contain one each of the below components (excluding 46798-0450)	
46798-0508	Display Console, X35
46798-0621	Terminal Mounting Bracket and Hardware
46798-0126	Mini CAN Terminator
11011-6416	Ty-Wrap Bundle 64-7 in. and 16-14 in.
46798-0455	System Power Harness with IBBC Connector
46798-0451A	Tractor Harness
46798-8501	Topcon X35 to X30 Adapter Harness
46798-5060S1	Tractor Electronic Control Unit (TECU)

Topcon X35 Virtual Terminal

Harness Diagram

Prescription map capable and logging of "as applied" data.

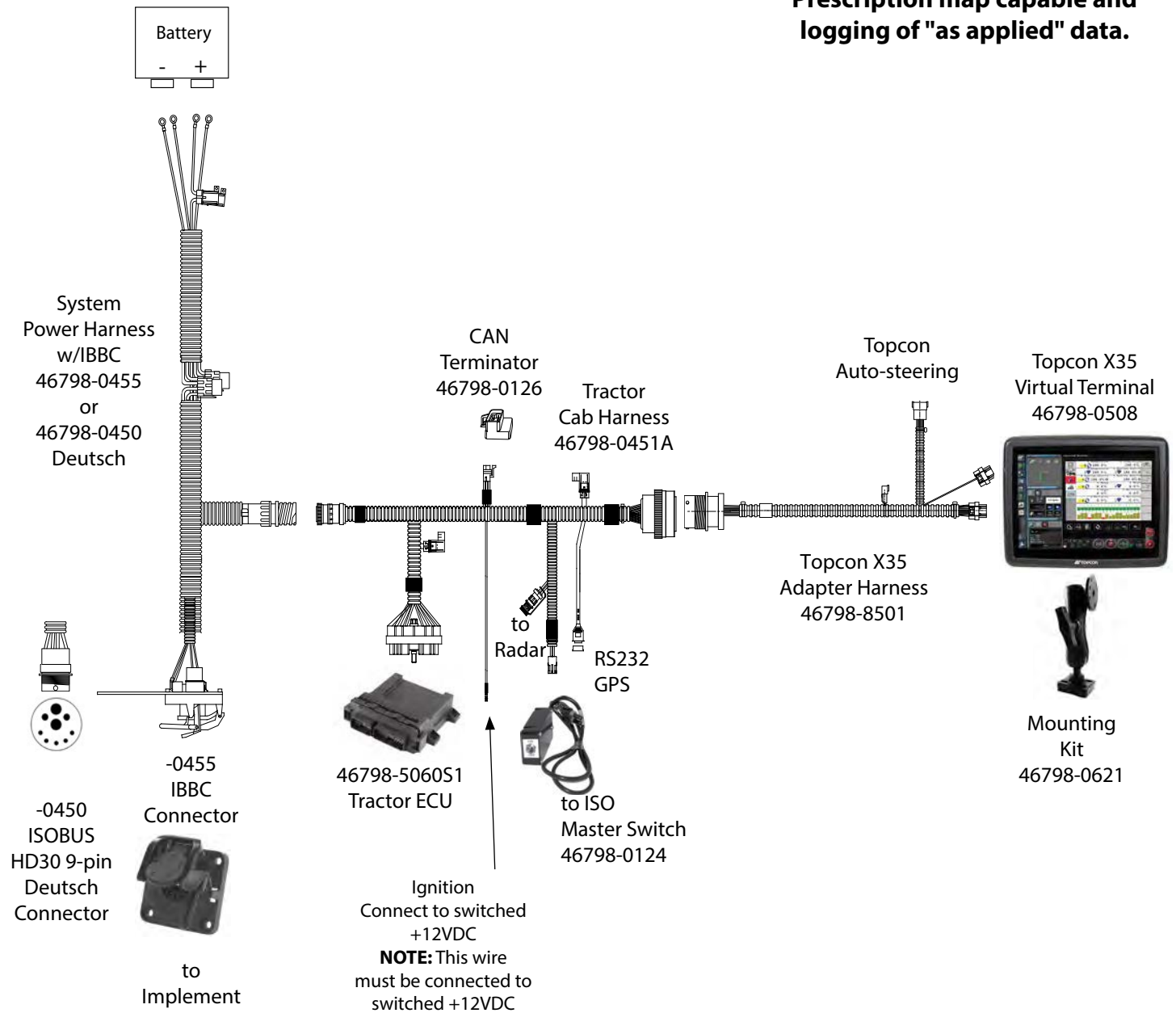

IntelliAg®

Camera and Accessories



An optional camera can be installed on the rear of the tractor or on the implement and connected to the Topcon X35, AI-100, and AI-50 terminal. Video displays on the terminal and provides the added benefits of:

- Viewing blind spots
- Backing up to implement
- View of implement activity while operating
- Safety pre-caution to reduce accidental equipment damage or bodily injury

Features:

- 100% waterproof
- Anodized solid aluminum housing
- Auto infrared night vision
- Heavy-duty mounting magnet
- Made in the USA

Camera and Accessories	
Part Number	Description
46649-5600	Camera; 4.3 Lens
46649-5645	Topcon X35 Monitor Adapter
46649-5640	AI-100 Monitor Adapter
46649-5610	AI-70 Monitor Adapter
46649-5650	Camera Cable Assembly, 5' auxiliary camera adapter
46649-5655	Camera Cable Assembly, 10' shielded video cable
46649-5620	Camera Cable Assembly, 20' shielded video cable
46649-5660	Camera Cable Assembly, 40' shielded video cable
46649-5665	Camera Cable Assembly, 50' shielded video cable
46649-5670	Camera Cable Assembly, 90° angled camera pigtail

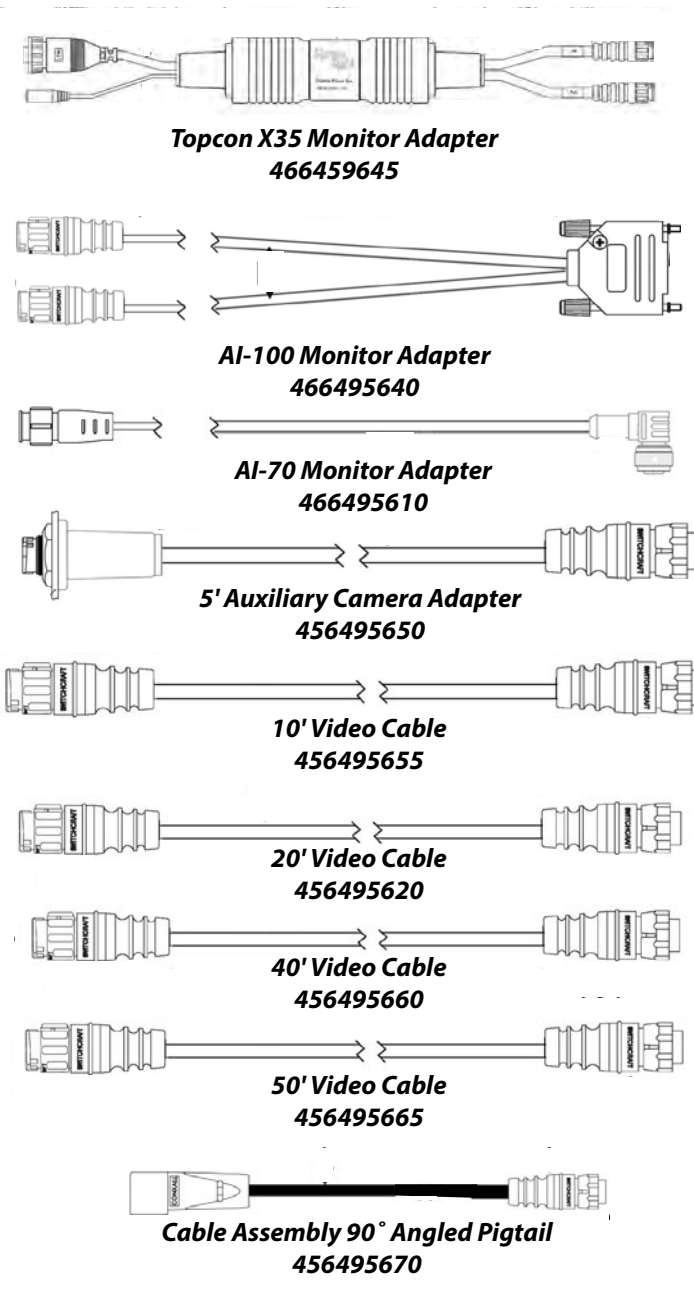

IntelliAg®

ISO₆

ISO ₆ Master Modules	
FEATURE KEY LEGEND	
ADV	Advanced Seed Data
TRM	Tramline
VS	Virtual Switches
FLD	Frame Fold
IRC	Individual Row Control
Part Number	Feature Keys
2 Channels	
46798-7413S1	
46798-7409S1	ADV
46798-7410S1	ADV, TRM
46798-7414S1	TRM
46798-7415S1	VS, TRM
46798-7416S1	ADV, VS
46798-7417S1	VS
46798-7430S1	ADV, VS, IRC
3 Channels	
467987418S1	
467987419S1	ADV
467987432S1	TRM
467987433S1	ADV, VS
467987420S1	ADV, VS, FLD
4 Channels	
467987423S1	
467987408S1	ADV
467987411S1	ADV, TRM
467987422S1	TRM
467987434S1	ADV, VS
467987421S1	VS
467987441S1	TRM, FLD
467987440S1	ADV, VS, IRC
5 Channels	
467987424S1	ADV
6 Channels	
467987425S1	
467987427S1	VS, TRM
467987426S1	ADV, VS
467987428S1	ADV, VS, TL
467987412S1	ADV, VS, FLD, TRM
467987429S1	ADV, FLD
467987431S1	ADV, FLD, IRC
7 Channels	
467987470S1	
467987471S1	ADV, VS, FLD, TRM
8 Channels	
467987480S1	
467987481S1	ADV, VS, FLD, TRM
467987482S1	ADV, VS, FLD, TRM, IRC



TOPCON



JOHN DEERE



CNH

The IntelliAg® ISO₆ is an intelligent agricultural implement control and monitoring system. Based on the ISO 11783 standard, this system provides up to eight channels of control for multiple material types such as seeding, granular, and liquid applications from one module.

The integration continues as ISO₆ provides advanced seed monitoring for row crop planting. Seed singulation and spacing quality are now provided as standard features, eliminating installation inconvenience and additional module and harnessing expense. These features, when combined with the Hy Rate™ Plus Seed Sensor, provide the most accurate planting data available at high seeding rates.

Designed for rapid utilization, the ISO₆ provides flexible feature sets that can easily be customized to meet specific needs. Implement fold sequencing is one example where those needs can be identified and incorporated with minimal effort. The result is the elimination of a switch module that would otherwise be required.

This same approach provides section shutoff capabilities without a switch module given the utilization of a universal terminal with virtual switches and task controller functionality.

- The ISO₆ platform provides an intuitive and user-friendly system setup and operation menu for all technological skill levels.
- Setup icons can be removed or restricted based on user levels for added system integrity.
- The main working screen interface is customizable and provides both a numerical and graphical representation of work that is being done.
- The size and location of instruments, such as a seeding rate gauge, can be altered for personal preference.
- The ISO₆ interface provides multiple page customization of differing information to provide more options for analysis of system performance.
- A major advantage of ISO₆ is a producer can use his existing ISOBUS Virtual Terminal, please see ISO₆ Technical Data Sheet for most updated list of tested compatible virtual terminals.

SECONDARY MODULES

Type	Part Number	Description
MEMBER MODULES		
WSMB	467981100S1	18 ROWS SENSOR INPUT (BASIC)
WSMB2	467988320S1	18 ROWS ADVANCED SEED DATA
OUTPUT MODULES		
POM	467982001S1	PLANTER OUTPUT MODULE
BOM	467982001S1	BOOM OUTPUT MODULE
TROM	467982002S1	TRAMLINE OUTPUT MODULE
FOLD MODULE		
FCOM	467982050S1	FOLD OUTPUT MODULE
FPOM	467982051S1	FOLD/CLUTCH OUTPUT MODULE
SWITCH MODULES		
RSM	467984264S1	ROW SWITCH MODULE (6)
BSM	467984030S1	BOOM SWITCH MODULE (6)
ESM	467984040S1	EXTENDED SWITCH MODULE (6)
ACCESSORY MODULES		
ACC Module	467981105S1	ACCESSORY INPUT MODULE
	467988335S1	WSMB2 ACC MODULE
IRC MODULES		
	452950061S1	IRC GENERIC MODULE DOGA
TCECU		
	467985060S1	TRACTOR ECU

HARNESSING

* HIGH CURRENT POWER CONNECTOR SUPPORT ONLY

Type	Part Number	Description
MAIN T HARNESS	467980850	37-PIN CPC PM STYLE W/ OUT APER
	467980851	DEUTSCH 12-PIN SE STYLE W/ OUT APER
	467980852	37-PIN CPC PM STYLE W/APER
	467980858	37-PIN CPC PM STYLE W/OUT APER 6 CHANNEL SUPPORT
	467980859*	HIGH CURRENT HARNESS, MOLEX CONNECTORS ONLY
CONTROL HARNESS	467980160	4 CH, 4 PWM, 2 SERVO, RPM, HOPPER W/O APER
	467980161	4 CH, 4 PWM, 2 SERVO, RPM, HOPPER W/APER
	467980164	4 CH, 4 PWM, 2 SERVO, HOPPER, RPM OR AIR
	467980162	2 CH, 2 PWM, 1 RPM, 1 HOPPER
	467980165	1 RPM, 1 HOPPER
	467980166	6 CH, 4 PWM, 2 SERVO, RPM, HOPPER W/OUT APER
	467980168*	PWM/SERVO CONTROL HARNESS
	467980191*	FEEDBACK/SWITCH HARNESS
	467980177*	4 PWM, 2 LINEAR ACTUATOR

HARNESSING CONTD.

Type	Part Number	Description
ACCESSORY HARNESS (CPC)	467980201	ACCESSORY HARNESS 4 AIR, 2 RPM, 3 HOPPER
	467980861	ACCESSORY 5 BOOM INPUTS 2 RPM, 2 HOPPER, 4 GATE HEIGHT
CAN/POWER EXTENSIONS	467980142	5' CAN/POWER Extension
	467980141	10' CAN/POWER Extension
	467980140	20' CAN/POWER Extension
	467980143	25' CAN/POWER Extension
	467980144	40' CAN/POWER Extension
	467980146	45' CAN/POWER Extension
WSMB/WSMB T HARNESS	467981200	37-PIN CPC AMP
	467981201A	DEUTSCH CONNECTORS
	467981806*	HIGH CURRENT HARNESS
WSMB OUTPUT HARNESS	467983505	TRU COUNT CLUTCH HARNESS 8 OUTPUTS
	467983100	6 LIQUID BOOM OUTPUT HARNESS (3-WIRE SHUTOFFS)
	467983101	6 LIQUID BOOM OUTPUT HARNESS (2-WIRE SHUTOFFS TO BOM)
	467982100	HARNESS 12 ROW SHUT OFF
	467983508	STANDARD POM HARNESS 6 OUTPUTS
FCOM HARNESSES	467983509	FCOM 8 OUTPUTS 4 INPUTS
DRIVER HARNESSES	464820521*	DRIVER HARNESS FOR PWM 5-8
	464820510S1	DRIVER HARNESS FOR CLUTCHES >2 AMPS
TROM HARNESSES	467983510*	TROM OUTPUT HARNESS
	467983511*	TROM LINEAR ACTUATOR OUPUT HARNESS
POWER ADAPTERS	467980483*	M POWELL TO F DEUTSCH ADAPTER
	467980484*	F POWELL TO M DEUTSCH ADAPTER
DROP SPREADER	467980178*	DROP SPREADER HARNESS

IntelliAg® WSMT2

Base System - Planter

- IntelliAg® Virtual Terminal Topcon X35
- Tractor harness for use virtual terminal
- System power harness with ISO hitch connector
- ISO master switch to control on/off
- Hitch extension harness
- PDC - WSMT2
- WSMT2 T harness
- Control harness for connection to valves and feedback sensors

Monitor and Control

Module WSMB



An accessory module is required for planters larger than 16 rows. Capable of processing 18 seed sensor inputs for communication to control module.

Module WSMB2



Seed singulation and spacing quality are available when using the WSMB2 module.

Accessory Module WSMB



Accessory module connects to the accessory harness to add up to 2 hopper, 2 air, and 2 RPM sensors.

WSMB



WSMTII-PDC



Air Pressure Sensor

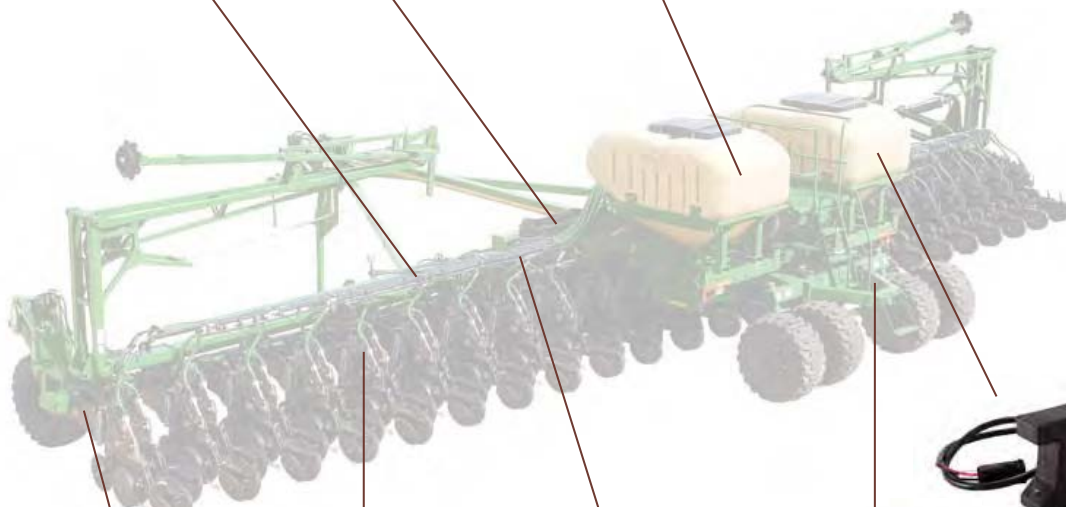

Application Rate Sensor



Hy Rate™ Seed Sensor



HD 4180™ Hydraulic Motor/Control Valve



Lift Switch



Hopper Level Sensor

IntelliAg® WSMT2

System Diagram

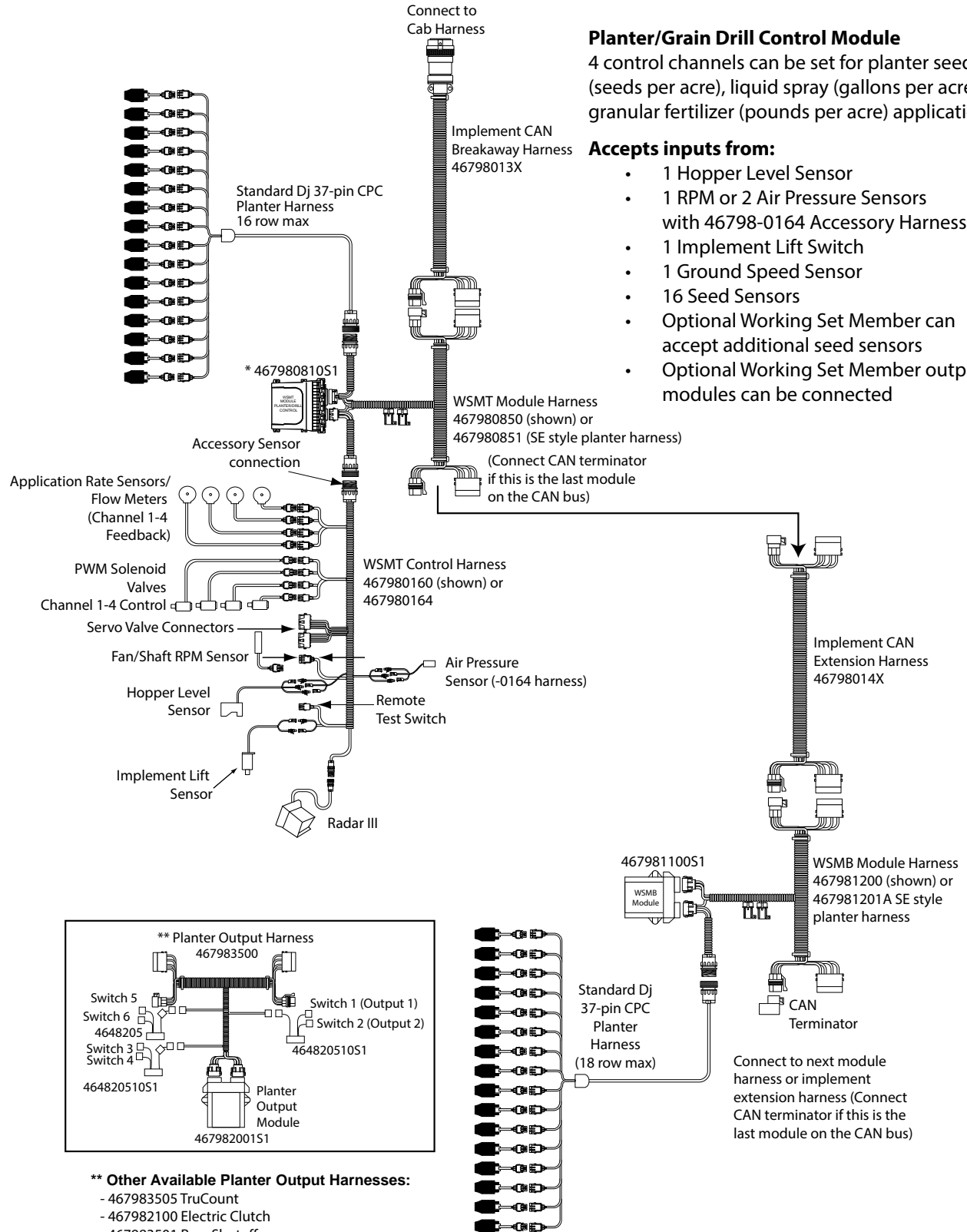

* Harnessing for WSMT2 4 channel control

IntelliAg® WSMT2

-0850 WSMT Harness without Servo APER
 (-0160 4 channel control harness without APER)

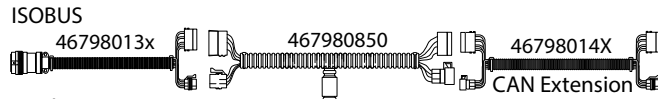

to cab system power harness at rear of tractor or to the implement bar for a pull behind

NOTE: -0850 is without Servo APER (application rate error) to be used with the -0160 control harness

to first WSMB on implement bar. Refer to page 17-18 for adding additional rows.

CAN Terminator included in 4 channel Implement dust plug kit 467980630

NOTE: -0160 is 4 channel control harness without APER (application rate error)

A 37-pin Dj planter row harness may be connected here

NOTE: 16 rows is the maximum number of seed sensors that can be connected to the WSMT

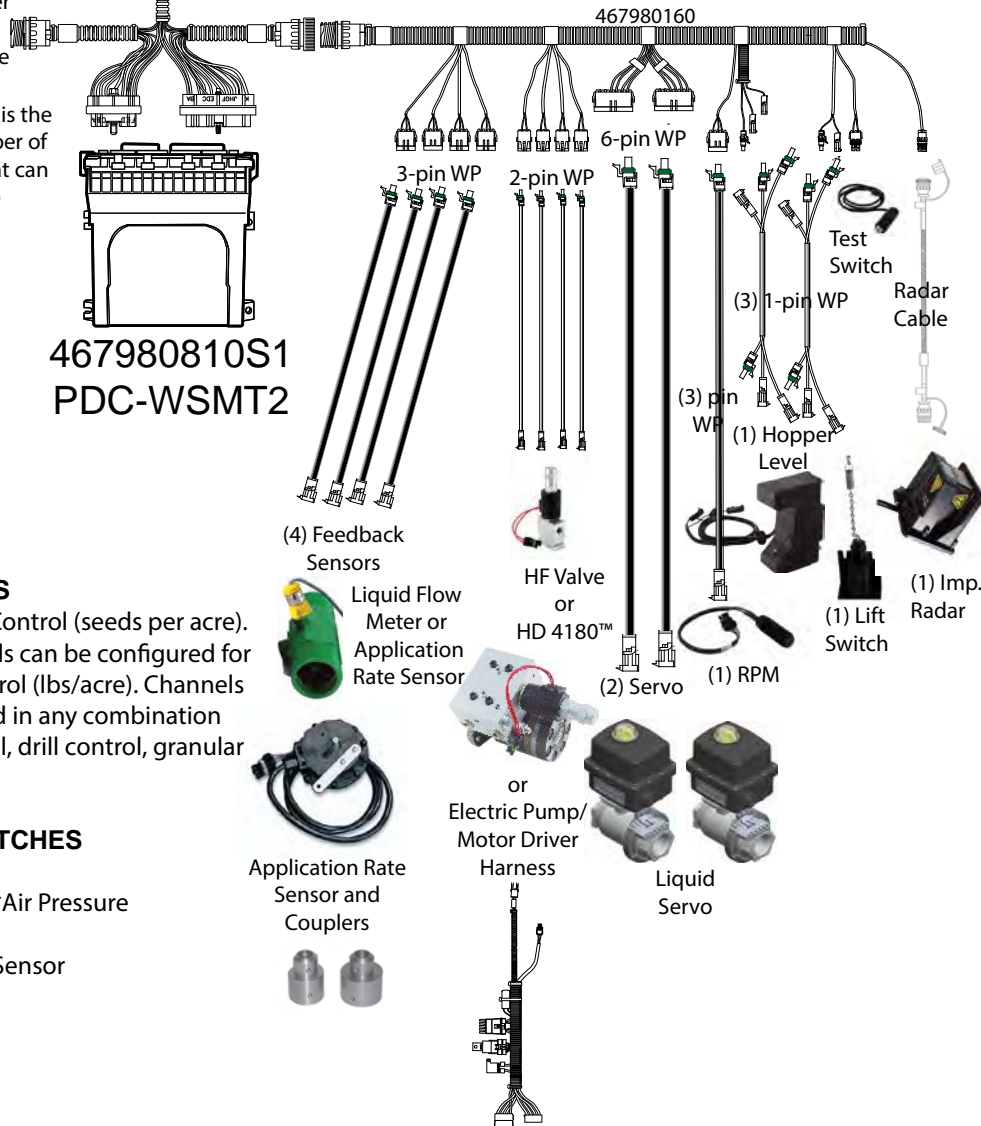

467980810S1
PDC-WSMT2

SYSTEM LIMITS

Planter Seeding Control (seeds per acre). However, channels can be configured for drill seeding control (lbs/acre). Channels can be configured in any combination for planter control, drill control, granular or liquid control.

SENSORS/SWITCHES

- 1 Hopper Level
- 1 RPM Sensor or *Air Pressure
- 1 Lift Switch
- 1 Ground Speed Sensor
- 16 Seed Sensors

* Requires 46798-0164 control harness, see illustration of control harnessing for a planter/drill using the -0164 control harness and the -0850 WSMT harness.

IntelliAg® WSMT2

System Parts List

HITCH EXTENSIONS

Part Number	Description
467980134	Hitch Extension 6'
467980132	Hitch Extension 10'
467980136	Hitch Extension 15'
467980131	Hitch Extension 20'
467980133	Hitch Extension 30'
467980130	Hitch Extension 40'
467980810S1	WSMT
467980850	WSMT Harness
467980142	CAN Extension 5'
467980141	CAN Extension 10'
467980140	CAN Extension 20'
467980143	CAN Extension 25'
467980144	CAN Extension 40'
467980146	CAN Extension 45'
467980630	4 Ch. Imp. Dust Plug Kit w/CAN Term.
110110099	Ty Wrap Bundle 100 14"
110011485	PDC User Manual
467980160	Control Harness

HOPPER LEVEL 1

Part Number	Description
466820720S3	Hopper Level Sensor
466820721S1	Hopper Level Sensor w/ 1/2" Bushing
466820713	3-1Pin WP Ext. Cable 5'
466820712S1	3-1Pin WP Ext. Cable 10'
466820714	3-1Pin WP Ext. Cable 15'
466820710S3	3-1Pin WP Ext. Cable 20'

RPM SENSOR 1

Part Number	Description
463500030S1	Hall Effect Sensor RPM (Smooth)
466970014S1	Hall Effect Sensor RPM (Threaded)
459680922	HES Ext. Cable 3Pin WP 15'

APPLICATION RATE SENSOR

Part Number	Description
464360178S1	Application Rate Sensor 360 1' Cable
464360176S1	AR Sensor 5' Cable
464360179S1	AR Sensor 6' Cable
464360170S1	AR Sensor 10' Cable
464360171S1	AR Sensor 15' Cable
464360177S1	AR Sensor 22' Cable
464360172S1	AR Sensor 30' Cable
457141810	App. Rate 1" Coupler
457141850	App. Rate 1.25" Coupler
467092218	HD4180 to AR Sensor Coupler & Hrdwre
467092221	HD4180 to AR Sensor Coupler
457901810	3Pin WP Ext. Cable 15'
457901811	3Pin WP Ext. Cable 30'
457901812	3Pin WP Ext. Cable 45'

LIFT SWITCH AND RADAR

Part Number	Description
463720150S1	Implement Lift Switch
464820520S1	Lift Switch - Whisker Type
466820713	3-1Pin WP Ext. Cable 5'
466820712S1	3-1Pin WP Ext. Cable 10'
466820714	3-1Pin WP Ext. Cable 15'
466820710S3	3-1Pin WP Ext. Cable 20'
467831000S9	Radar III w/ 14' Cable & Mtg Brkt
439400024	Radar Extension 10'
439400065	Radar Extension 15'
439400064	Radar Extension 25'
464210515S1	Test Switch

FLOW METERS

Part Number	Description
466491170S1	Flow Meter 1/2"
PM00370023S1	Flow Meter 3/4"
PM00370030S1	Flow Meter 1"
PM00370040S1	Flow Meter 1.5"
PM00370048S1	Flow Meter 2"
PM00370068S1	Flow Meter 3"
PM00370088S1	Flow Meter 4"
PMNPT70116S1	SS Flow Meter 1/2"
PMNPT70121S1	SS Flow Meter 3/4"
PMNPT70126S1	SS Flow Meter 1"
PMNPT70136S1	SS Flow Meter 1-1/2"
PMNPT70146S1	SS Flow Meter 2"
457901810	3Pin WP Ext. Cable 15'
457901811	3Pin WP Ext. Cable 30'
457901812	3Pin WP Ext. Cable 45'

LIQUID VALVE AND ACTUATOR (LIQUID FLOW CONTROL)

Part Number	Description
467095010	Valve & Actuator Assy. 3/8" 2-Way Stainless Steel
467095220	Valve & Actuator Assy. 3/8" 3-Way Stainless Steel
467095020	Valve & Actuator Assy. 1/2" 2-Way Stainless Steel
467095030	Valve & Actuator Assy. 3/4" 2-Way Poly
467095280	Valve & Actuator Assy. 1" 2-Way Poly
467095290	Valve & Actuator Assy. 1" 2-Way Stainless Steel
467095050	Valve & Actuator Assy. 1-1/2" 3-Way Poly
467095140	Valve & Actuator Assy. 1-1/2" 3-Way Stainless Steel
467095150	Valve & Actuator Assy. 2" 2-Way Stainless Steel
467095160	Valve & Actuator Assy. 2" 3-Way Stainless Steel
467095170	Valve & Actuator Assy. 3" 2-Way Stainless Steel
457901820	6Pin WP Extension Cable 15'
457901821	6Pin WP Extension Cable 30'

ELECTRIC MOTOR DRIVER

Part Number	Description
467980490	High Current Electric Motor Harness
467980390	Power Harness (high current < 10 Amps)

PULSE-WIDTH MODULATION CONTROLS 1-4

Part Number	Description
467092004S1	Hydraulic Valve HydraForce 4 GPM
467092008S1	Hydraulic Valve HydraForce 8 GPM
467092050S1	Hydraulic Valve HydraForce 25 GPM
467092200S1	HD4180 w/Integrated Valve
467092219	HD4180 Mounting Bracket
467092219S1	HD4180 Pltr Mtg Brckt & Hardware Kit
467980470	12 Ga. 2Pin WP Ext. Cable 15'
467980471	12 Ga. 2Pin WP Ext. Cable 20'
467980473	12 Ga. 2Pin WP Ext. Cable 30'
467980472	12 Ga. 2Pin WP Ext. Cable 40'

IntelliAg® WSMT2

-0850 WSMT Harness without APER
 (-0164 4 channel control harness without APER)

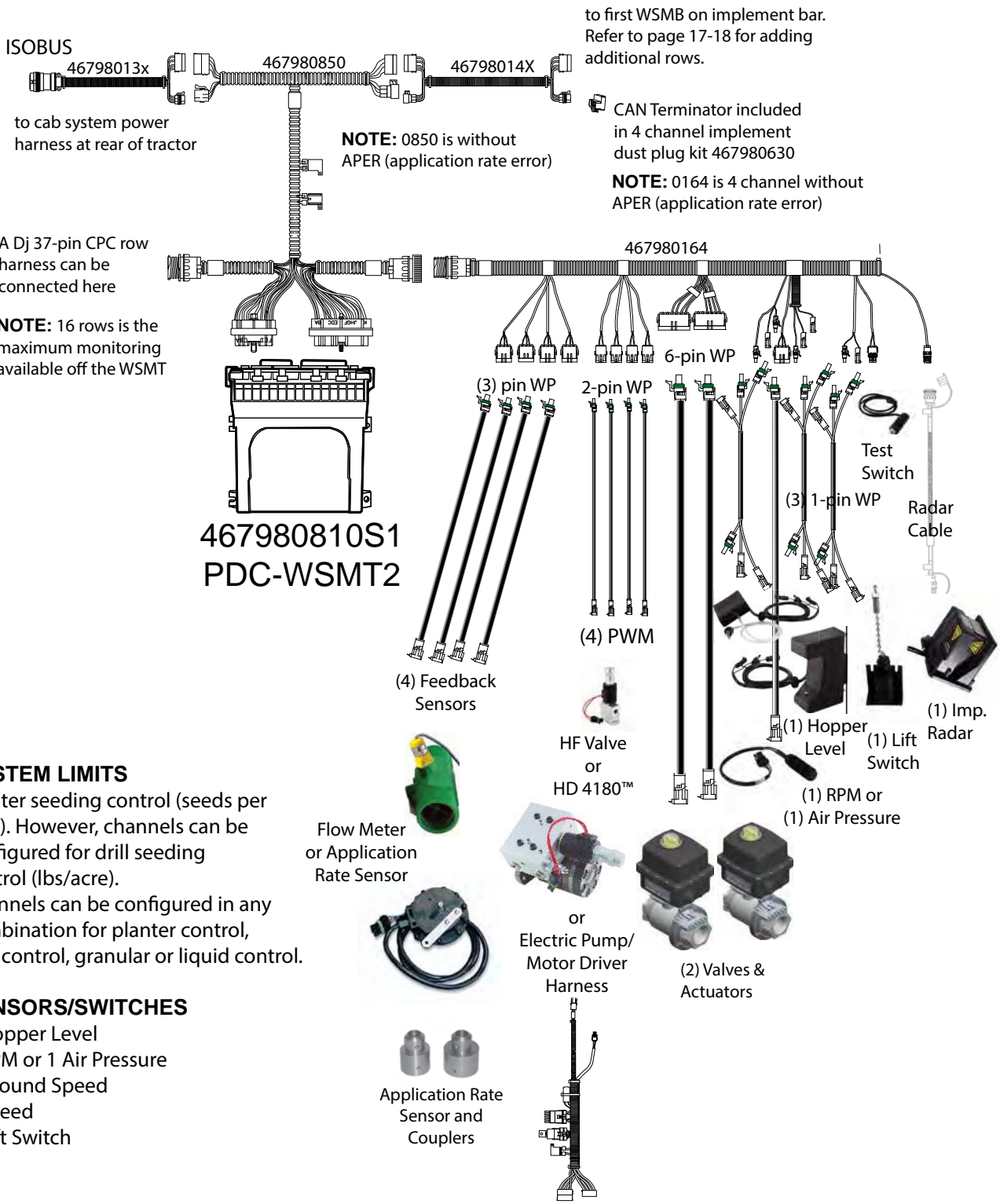

ISOBUS
 46798013x
 to cab system power harness at rear of tractor

to first WSMB on implement bar.
 Refer to page 17-18 for adding additional rows.

NOTE: 0850 is without APER (application rate error)

CAN Terminator included in 4 channel implement dust plug kit 467980630

NOTE: 0164 is 4 channel without APER (application rate error)

A Dj 37-pin CPC row harness can be connected here
NOTE: 16 rows is the maximum monitoring available off the WSMT

467980810S1
 PDC-WSMT2

SYSTEM LIMITS
 Planter seeding control (seeds per acre). However, channels can be configured for drill seeding control (lbs/acre). Channels can be configured in any combination for planter control, drill control, granular or liquid control.

- SENSORS/SWITCHES**
- 1 Hopper Level
 - 1 RPM or 1 Air Pressure
 - 1 Ground Speed
 - 16 Seed
 - 1 Lift Switch

IntelliAg® WSMT2
System Parts List
HITCH EXTENSIONS

Part Number	Description
467980134	Hitch Extension 6'
467980132	Hitch Extension 10'
467980136	Hitch Extension 15'
467980131	Hitch Extension 20'
467980133	Hitch Extension 30'
467980130	Hitch Extension 40'
467980135	Hitch Extension 50'
467980810S1	WSMT
467980850	WSMT Harness
467980142	CAN Extension 5'
467980141	CAN Extension 10'
467980140	CAN Extension 20'
467980143	CAN Extension 25'
467980144	CAN Extension 40'
467980146	CAN Extension 45'
467980630	4 Ch. Imp. Dust Plug Kit w/CAN Term.
110110099	Ty Wrap Bundle 100 14"
110011485	PDC User Manual
467980164	Control Harness

HOPPER LEVEL 1

Part Number	Description
466820720S3	Hopper Level Sensor
466820721S1	Hopper Level Sensor w/ 1/2" Bushing
466820713	3-1Pin WP Ext. Cable 5'
466820712S1	3-1Pin WP Ext. Cable 10'
466820714	3-1Pin WP Ext. Cable 15'
466820710S3	3-1Pin WP Ext. Cable 20'

RPM SENSOR 1

Part Number	Description
463500030S1	Hall Effect Sensor RPM (Smooth)
466970014S1	Hall Effect Sensor RPM (Threaded)
459680922	HES Ext. Cable 3Pin WP 15'

APPLICATION RATE SENSOR

Part Number	Description
464360178S1	Application Rate Sensor 360 1' Cable
464360176S1	AR Sensor 5' Cable
464360179S1	AR Sensor 6' Cable
464360170S1	AR Sensor 10' Cable
464360171S1	AR Sensor 15' Cable
464360177S1	AR Sensor 22' Cable
464360172S1	AR Sensor 30' Cable
457141810	App. Rate 1" Coupler
457141850	App. Rate 1.25" Coupler
467092221	HD4180 to AR Sensor Coupler
457901810	3Pin WP Ext. Cable 15'
457901811	3Pin WP Ext. Cable 30'
457901812	3Pin WP Ext. Cable 45'

LIFT SWITCH AND RADAR

Part Number	Description
463720150S1	Implement Lift Switch
464820520S1	Lift Switch - Whisker Type
466820713	3-1Pin WP Ext. Cable 5'
466820712S1	3-1Pin WP Ext. Cable 10'
466820714	3-1Pin WP Ext. Cable 15'
466820710S3	3-1Pin WP Ext. Cable 20'
467831000S9	Radar III w/ 14' Cable & Mtg Brkt
439400024	Radar Extension 10'
439400064	Radar Extension 25'
464210515S1	Test Switch

AIR PRESSURE 1-4

Part Number	Description
466820920S1	Air Pressure Sensor
466820922S1	Air Pressure Sensor w/ 1/2" Bushing
466820713	3-1Pin WP Ext. Cable 5'
466820712S1	3-1Pin WP Ext. Cable 10'
466820714	3-1Pin WP Ext. Cable 15'
466820710S3	3-1Pin WP Ext. Cable 20'

PULSE-WIDTH MODULATION CONTROLS 1-4

Part Number	Description
467092004S1	Hydraulic Valve HydraForce 4 GPM
467092008S1	Hydraulic Valve HydraForce 8 GPM
467092050S1	Hydraulic Valve HydraForce 25 GPM
467092200S1	HD4180 w/Integrated Valve
467092219	HD4180 Mounting Bracket
467092219S1	HD4180 Pltr Mtg Brckt & Hardware Kit
467980470	12 Ga. 2Pin WP Ext. Cable 15'
467980471	12 Ga. 2Pin WP Ext. Cable 20'
467980473	12 Ga. 2Pin WP Ext. Cable 30'
467980472	12 Ga. 2Pin WP Ext. Cable 40'

FLOW METERS

Part Number	Description
PM00370018S1	Flow Meter 1/2"
PM00370023S1	Flow Meter 3/4"
PM00370030S1	Flow Meter 1"
PM00370040S1	Flow Meter 1.5"
PM00370048S1	Flow Meter 2"
PM00370068S1	Flow Meter 3"
PM00370088S1	Flow Meter 4"
PMNPT70116S1	SS Flow Meter 1/2"
PMNPT70121S1	SS Flow Meter 3/4"
PMNPT70126S1	SS Flow Meter 1"
PMNPT70136S1	SS Flow Meter 1-1/2"
PMNPT70146S1	SS Flow Meter 2"
457901810	3Pin WP Ext. Cable 15'
457901811	3Pin WP Ext. Cable 30'
457901812	3Pin WP Ext. Cable 45'

LIQUID VALVE AND ACTUATOR (LIQUID FLOW CONTROL)

Part Number	Description
467095010	Valve & Actuator Assy. 3/8" 2-Way Stainless Steel
467095220	Valve & Actuator Assy. 3/8" 3-Way Stainless Steel
467095020	Valve & Actuator Assy. 1/2" 2-Way Stainless Steel
467095030	Valve & Actuator Assy. 3/4" 2-Way Poly
467095280	Valve & Actuator Assy. 1" 2-Way Poly
467095290	Valve & Actuator Assy. 1" 2-Way Stainless Steel
467095050	Valve & Actuator Assy. 1-1/2" 3-Way Poly
467095140	Valve & Actuator Assy. 1-1/2" 3-Way Stainless Steel
467095150	Valve & Actuator Assy. 2" 2-Way Stainless Steel
467095160	Valve & Actuator Assy. 2" 3-Way Stainless Steel
467095170	Valve & Actuator Assy. 3" 2-Way Stainless Steel
457901820	6Pin WP Extension Cable 15'
457901821	6Pin WP Extension Cable 30'

ELECTRIC MOTOR DRIVER

Part Number	Description
467980490	High Current Electric Motor Harness
467980390	Power Harness (high current < 10 Amps)

ISO₆ SPECIFIC HARNESSES

Part Number	Description
467980858	WSMT ISO ₆ T Harness
467980166	6 Channel Control Harness
467983509	Frame Fold Harness

IntelliAg® WSMT2

Row Harnesses

Add Additional Rows

37-pin CPC WSMB Harness

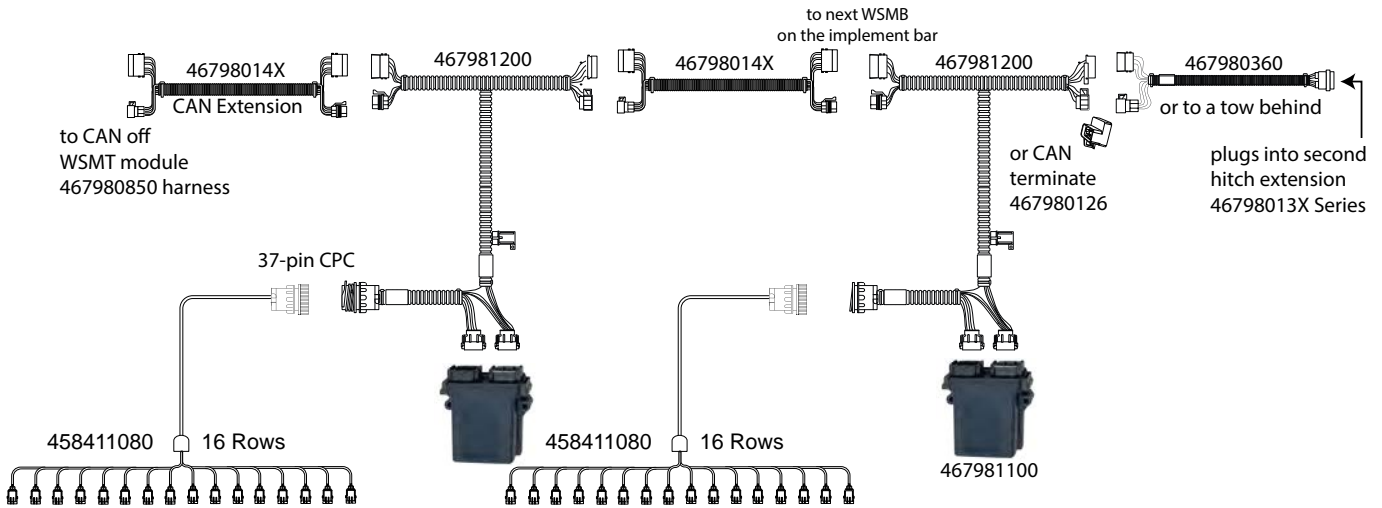

SYSTEM LIMITS
 18 Seed Rows per WSMB
 12 WSMB modules per ACC WSMT
 10 WSMB modules per PDC WSMT

SE Style WSMB Harness

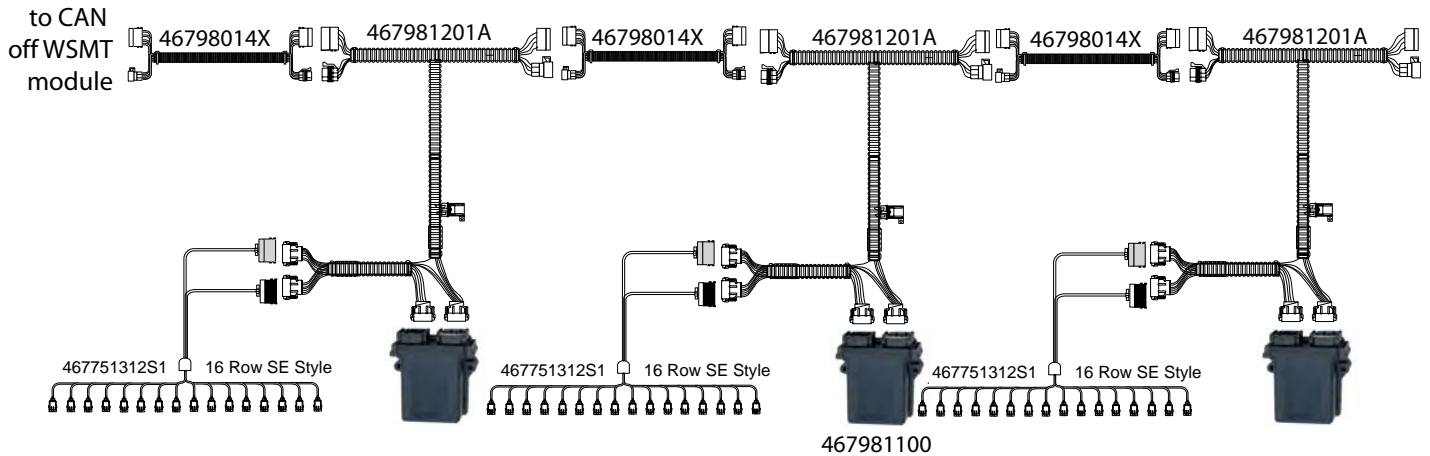

IntelliAg® WSMT2

System Parts List

HITCH EXTENSIONS

Part Number	Description
467980134	Hitch Extension 6'
467980132	Hitch Extension 10'
467980136	Hitch Extension 15'
467980131	Hitch Extension 20'
467980133	Hitch Extension 30'
467980130	Hitch Extension 40'
467980135	Hitch Extension 50'
467981100S1	WSMB
467981201	WSMB Harness
467980142	CAN Extension 5'
467980141	CAN Extension 10'
467980140	CAN Extension 20'
467980143	CAN Extension 25'
467980144	CAN Extension 40'
467980146	CAN Extension 45'
467980126	CAN Terminator

CAN TO HITCH CONNECTOR HARNESS

THIS HARNESS ACCOMMODATES DISCONNECTION OF A TOW BEHIND.

Part Number	Description
467980360	Rear Implement Hitch Harness 3'
467980361	Rear Implement Hitch Harness IBBC 6'
467980362	Rear Implement Hitch Harness IBBC 20'
467980363	Rear Implement Hitch Harness IBBC 25'

ROW HARNESS (37-PIN CPC)

Part Number	Description
458410530	4 Row Planter Harness
458410550	6 Row Planter Harness
458410570	8 Row Planter Harness
458410590	12 Row Planter Harness
458411080	16 Row Planter Harness (in diagram)
459680960	12 Row Y Cable to use 2-6 Row Pltr Hrn
459680950	16 Row Y Cable to use 2-8 Row Pltr Hrn
458410600	16 Row 2-8 Row Pltr Hrn w/16 Row Y
459680940	24 Row Y Cable to use 2-12 Row Hrn
467980445	JD 32 Row Reverse Y Harness
467980446	32 Row Reverse Y Harness
CASE IH	
458410860	12 Row Horz. Fold
459680321	REQUIRES 30' Extensions
458410610	16 Row Horz. Fold
459680321	REQUIRES 30' Extensions
KINZE	
458410570	8 Row Econo Fold
458410810	REQUIRES 6' Extension (16 row)
458410610	12 Row Econo Fold
458410810	REQUIRES 30' Extension
STACKER BAR	
458410980	2 Row Tri-Cable
458411010	12 Row Tri-Cable

ROW HARNESS EXTENSIONS

Part Number	Description
458410810	6 ft. Extension (16 row)
459680320	15 ft. Extension (16 row)
459680321	30 ft. Extension (16 row)
458410820	15 ft. Extension (32 row)
458410790	30 ft. Extension (32 row)

ROW HARNESS (SE STYLE)

Part Number	Description
Used In This Example:	
467980280	18 Row SE style Air Cart
Other SE style Harnesses:	
467751300S1	12 Row 7.5"
467751301S1	12 Row 15"
467751302S1	12 Row 30"
467751310S1	16 Row 7.5"
467751311S1	16 Row 15"
467751312S1	16 Row 30"
467751320S1	12 Row Air Cart
467751330S1	16 Row Air Cart
467980280	18 Row Air Cart

SEED SENSOR EXTENSIONS

Part Number	Description
459680920	3' Sensor Extension 3Pin WP
459680923S1	4' Sensor Extension 3Pin WP
459680921	6' Sensor Extension 3Pin WP
459680922	15' Sensor Extension 3Pin WP

SEED AND BLOCKAGE SENSORS

Part Number	Description
151350008	Small Tube A25925
452440881A	Small Grain CT w/Hi Rate (Vacuum)
452440971	Small Grain Curved Tube w/Hi Rate
452440980	Monosem Chute w/Hi Rate NG
452441010S3	AGCO White 6100 Hi-Rate
453520350S1	Nodet Sensor Only
453520360S1	Nodet Chute & Sensor
453520370S1	Nodet Planter II
454650271	Monosem PBC PNU
454650330S1	Monosem NG
454910750S1	Case ASM Hi-Rate
461530420S1	Small Tube Vacuum Planter
461642230S3	Cyclo Air 400/500/800/900
461700030S1	Landoll
467120030S3	AGCO White 5100 & 7500
461800060	Buffalo Plateless Planter
465260010S1	Hi-Rate Grain Drill
465790010S3	Jeantill
467420010S1	Recon Material Flow
467420100S1	Recon Flow with 2' Harness
467420701S1	Vigilense 25 mm
467420702S1	Vigilense 25 mm with SS Insert
467420711S1	Vigilense 32 mm
467420712S1	Vigilense 32 mm with SS Insert
467420730S1	Vigilense 32 mm with SS Outlet
467420720S1	Vigilense 45 mm
467420721S1	Vigilense 45 mm with SS Insert
467700090S1	Monosem Mecca 2000
467700100S1	Monosem MS Vegetable
467700220S1	Stanhay Dart II
467760010S1	Case ASM Hi-Rate Sensor Only

IntelliAg® WSMT2



WSMT2 Module

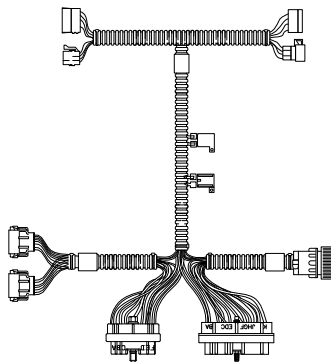

WSMT Harness 46798-0851

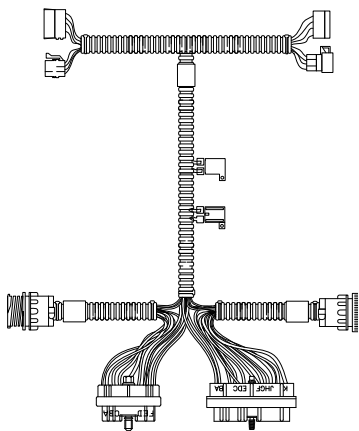

WSMT Harness 46798-0850 and -0852



**Cab to Implement Harness Hitch Extension
46798013X**

Working Set Master Module

The Working Set Master Module (WSMT2) houses the system's primary interface device. All system parameters, constants, and memory are stored in the WSMT and controls the application of material by interfacing with proportional hydraulic valves and feedback sensors. Several WSMT modules are available for a variety of applications.

Working Set Master Module	
Part Number	Description
46798-0810S1	Module, PDC-WSMT2 (Planter/Drill Control)
46798-0630	4 Channel Implement Dust Plug Kit with Terminators
11011-0099	Ty Wrap Bundle 100 14 in.

Working Set Master Harness

WSMT Harnessing	
Part Number	Description
46798-0850	WSMT Harness 37-pin CPC without APER (PDC)
46798-0851	WSMT Harness Seed Manager SE style without APER (PDC)
46798-0852	WSMT Harness 37-pin CPC with APER (Material Application)

NOTE: SE style harnesses have 1 gray and 1 black 12-pin Deutsch DT connector.

Cab to WSMT Harness Hitch Extension

Tractor Cab to Implement Harness Hitch Extensions	
Part Number	Description
46798-0134	6 ft. Hitch Extension ISO system CAN
46798-0132	10 ft. Hitch Extension ISO system CAN
46798-0136	15 ft. Hitch Extension ISO system CAN
46798-0131	20 ft. Hitch Extension ISO system CAN
46798-0133	30 ft. Hitch Extension ISO system CAN
46798-0130	40 ft. Hitch Extension ISO system CAN
46798-0135	50 ft. Hitch Extension
46798-0457	40 ft. Hitch to Hitch Extension

Implement Kit

IAPDCIMPKIT Planter/Drill Control Implement Kit consists of the following	
Part Number	Description
46798-0810S1	Module, PDC-WSMT2 (Planter/Drill Control)
46798-0850	WSMT Harness 37-pin CPC without APER (PDC)
46798-0160	Control Harness
46798-0630	4 Channel Implement Dust Plug Kit with Terminators
11001-1509A	Operator's Manual User Level 2
11001-1510	Operator's Manual User Level 1

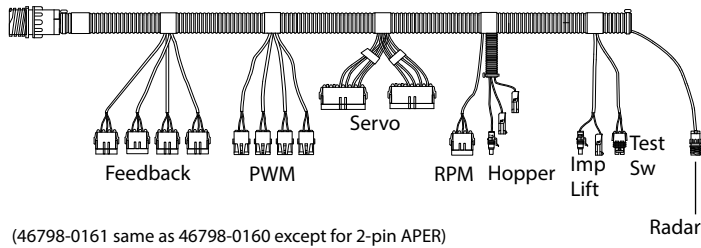
IntelliAg® WSMT2
WSMT Harnesses (Control Channel/Accessory Inputs)

(46798-0161 same as 46798-0160 except for 2-pin APER)

4 Channel Control Harness PDC 46798-0160

37-pin CPC Control Harnesses	
Part Number	Description
46798-0160	WSMT Planter Drill Control 4 Ch Control Harness without APER (app error rate)
46798-0161	WSMT Material Application 4 Ch Control Harness with APER (app error rate)
46798-0162	WSMT Planter Drill Control 2 Ch Control/Sensor Harness
46798-0164	WSMT 4 Ch Control Harness with RPM/ Air Pressure
46798-0165	Monitor Only Harness

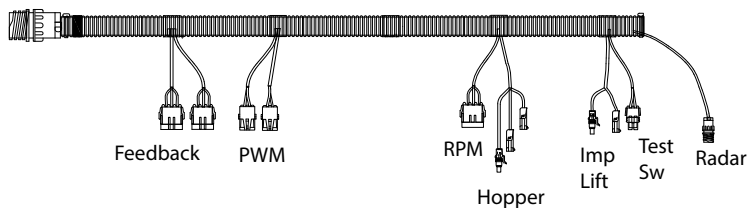

Harness PDC 46798-0162

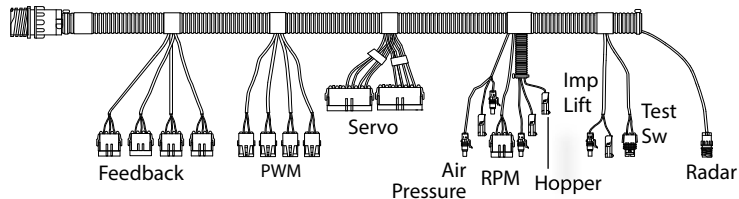

**Pressure Harness with RPM/Air Pressure
46798-0164**

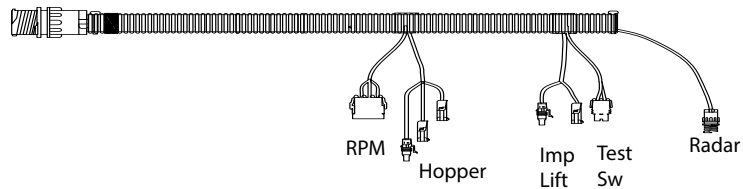

**Monitor Only Harness (PDC)
46798-0165**

IntelliAg® WSMT2

Row Monitoring/Seed Singulation/Accessories



WSMB



WSMB2
Seed Singulation



Accessory Module

Working Set Member Module

The Working Set Member Module (WSMB) is an auxiliary to the Working Set Master Module (WSMT). Each WSMB can accept up to 18 rows of seed sensors and passes information direct to the WSMT. Up to 10 WSMB's can be installed to monitor up to 196 rows. The flexible design allows for installation virtually any where on the implement.

Seed Singulation (WSMB2)

Seed singulation and spacing quality are features available when adding a Working Set Member 2 (WSMB2) module to the IntelliAg® system that displays how seeds are planted within each seed row.

Singulation displays a percentage of seeds counted versus seeds expected. Spacing quality reflects how much spacing is occurring between each seed while planting and provides a comparison of row-to-row meter performance.

Accessory Module

Accessory module allows the addition of 2 hopper, 2 air, and 2 RPM sensors. Accessory module connects to the Accessory harness 46798-0205.

Working Set Member Modules	
Part Number	Description
46798-1100S1	WSMB Module (18 seed rows)
46798-1105S1	WSMB Accessory Module (2 hopper, 2 air, 2 RPM)
46798-8320S1	WSMB2 Module (Seed Singulation and Spacing Quality)
46798-8335S1	WSMB2 ACC Module

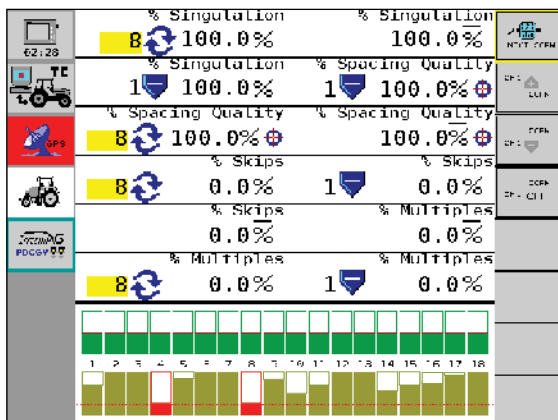

IntelliAg® Work Screen displaying Seed Singulation %, Spacing Quality, Skips, and Multiples

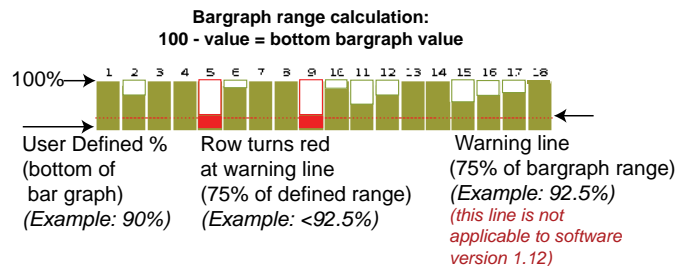

IntelliAg® WSMT2

WSMB Harnessing

WSMB Harness

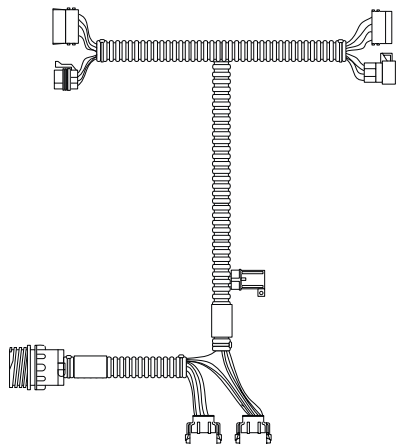

46798-1200 WSMB Harness
 Connects to 37-pin CPC Row Planter Harness

WSMB Harnesses	
Part Number	Description
46798-1200	WSMB Harness to 37-pin CPC Planter Row Harness (connects to 46798-1100S1)
46798-1201A	WSMB Harness Accessory T Harness (connects to 46798-1105S1)
46798-0205	WSMB Accessory Harness

WSMB CAN Extension Harness

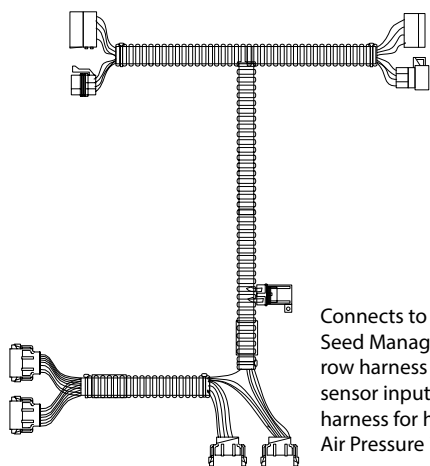

46798-1201A WSMB Harness SE Style
 WSMB Harness SE style row connection has 1 gray and 1 black, 12-pin Deutsch DT connector

Connects to Seed Manager® SE planter row harness for seed sensor inputs or Accessory harness for hopper and Air Pressure inputs.

WSMB Harnesses	
Part Number	Description
46798-0142	WSMB Extension 5 ft.
46798-0141	WSMB Extension 10 ft.
46798-0140	WSMB Extension 20 ft.
46798-0143	WSMB Extension 25 ft.
46798-0144	WSMB Extension 40 ft.
46798-0146	WSMB Extension 45 ft.

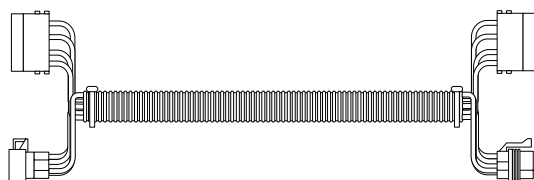

46798-014X WSMB Extension Harness

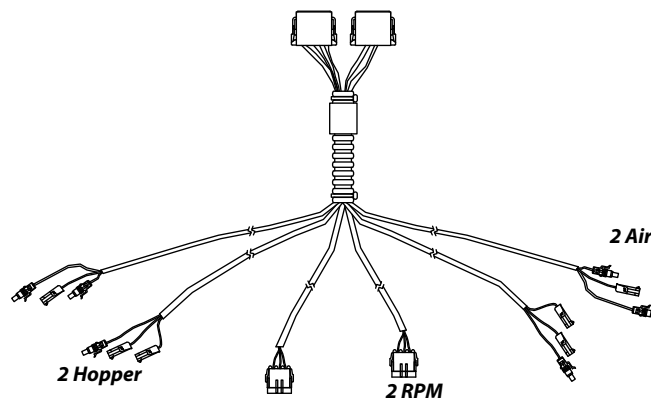

WSMB Accessory Harness
467980205

IntelliAg® WSMT2

CAN to Hitch Connector Harnesses

Harness accommodates disconnection between implement and tow-behind air-cart to second hitch extension.



Rear Implement Hitch Harness
46798-0360, 0361, 0362, 0363

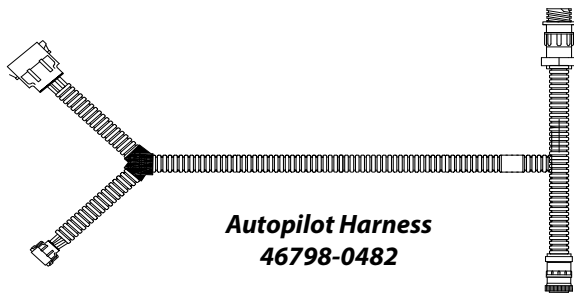

Autopilot Harness
46798-0482

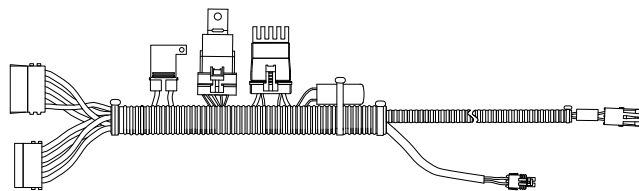

Electric Motor Driver
46798-0490



Case Tractor Cab Harness
46798-0330

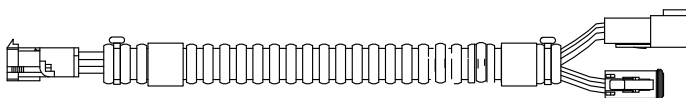

CFM to JD GS2 Cab Harness
46798-0335

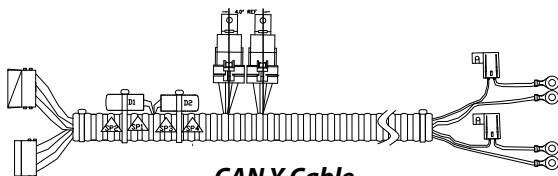

CAN Y Cable
46798-0390

Rear Implement Hitch Harness	
Part Number	Description
46798-0360	Rear Implement Hitch Harness with Deutsch 9-pin (CAN to Hitch) 3 ft.
46798-0361	Rear Implement Hitch Harness with IBBC 9-pin (CAN to Hitch) 6 ft.
46798-0362	Rear Implement Hitch Harness with IBBC 9-pin 20 ft.
46798-0363	Rear Implement Hitch Harness with IBBC 9-pin 25 ft.

Adapter Harnesses

Adapter Harness	
Part Number	Description
46798-0482	Autopilot Interface Harness to IntelliAg
46798-0490	Electric Motor Driver (solenoid relay cable for high current electric motor drive)
46798-0330	Case Tractor Cab Harness to Dj Boom Switch Module (CAN to CAN Extension)
46798-0335	CFM to JD GS2 Cab Harness
46798-0128	European ISO Tractor Harness (short) without IBBC connector
46798-0390	ADX Power Harness

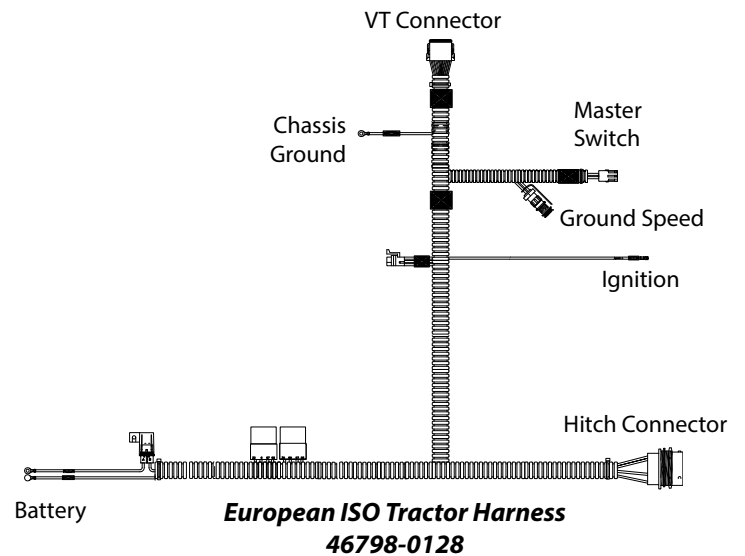

IntelliAg® WSMT2

WSMB Output Module

A WSMB Output Module communicates with the Row and Boom Switch Module for section on/off control.

Row Shutoff Parts	
Part Number	Description
46798-2001S1	Planter Output Module (POM)
46798-3501	Row Shutoff Planter Output Module Harness (disengage)
46798-3504	Planter Output Module Harness for Electric Clutches (engage)
46798-3505	Tru Count Clutch Module Harness
46798-3508	Planter POM Harness
46798-3100	Liquid Boom Shutoff Harness (6 Boom/3-Wire Shutoff)
46798-3101	Liquid Boom Shutoff Harness (6 Boom/2-Wire Shutoff) (used with non-DICKEY-john® Valves and 464820510)
46798-2100	Row Shutoff (RSO) Harness (12 solenoid)
46482-0510S1	Solenoid Driver (plugs into 46798-3501 and -3101 for current >2 Amp)

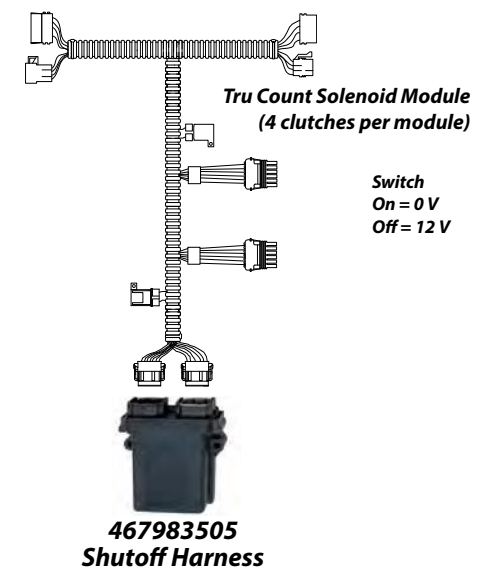
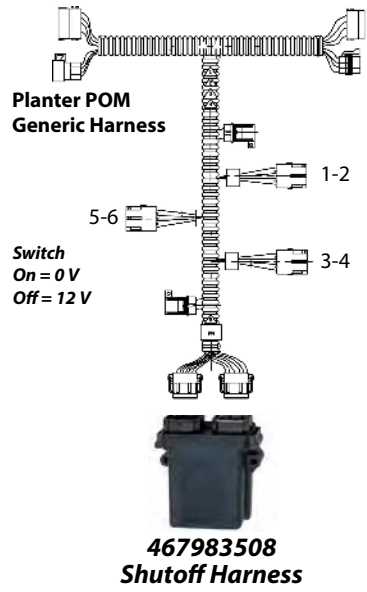
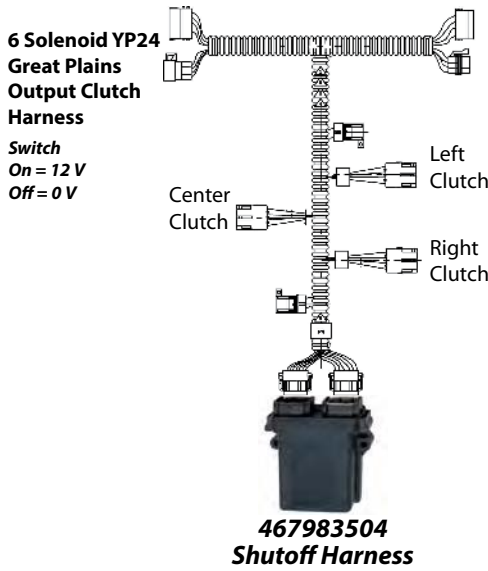
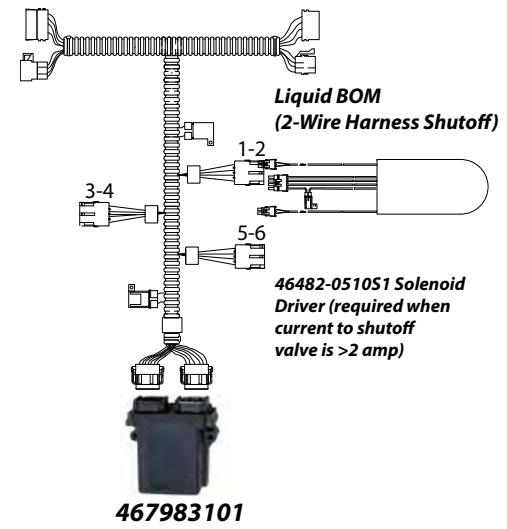
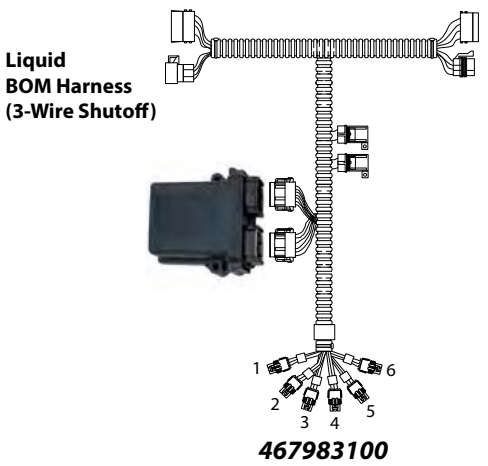
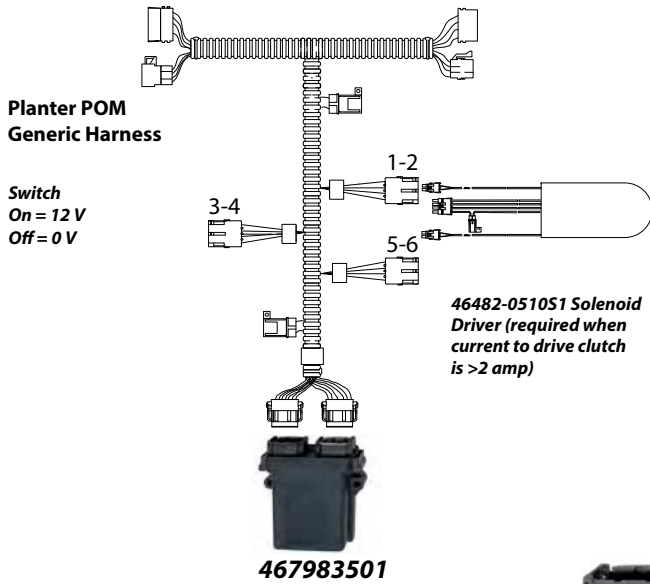

IntelliAg® WSMT2

System Parts List

CAN EXTENSION HARNESES

Part Number	Description
467980142	CAN Extension 5'
467980141	CAN Extension 10'
467980140	CAN Extension 20'
467980143	CAN Extension 25'
467980144	CAN Extension 40'
467980146	CAN Extension 45'
467980126	CAN Terminator

ROW SHUT OFF HARNESES

Part Number	Description
467983501	Planter Output Module Harness
467983505	Tru Count Clutch w/8 Output

OUTPUT MODULE

Part Number	Description
467982001S1	Working Set Member Module (WSMB)

REQUIRED DRIVERS

Part Number	Description
46482010S1	Solenoid Driver

WEATHER PAK EXTENSIONS

Part Number	Description
467980470	12 Ga. 2Pin WP Ext. Cable 15'
467980471	12 Ga. 2Pin WP Ext. Cable 20'
467980473	12 Ga. 2Pin WP Ext. Cable 30'
467980472	12 Ga. 2Pin WP Ext. Cable 40'
457901810	3Pin WP Ext. Cable 15'
457901811	3Pin WP Ext. Cable 30'
457901812	3Pin WP Ext. Cable 45'
457901820	6Pin WP Ext. Cable 15'
457901821	6Pin WP Ext. Cable 30'

ROW SHUT OFF MODULES

Part Number	Description
467984264S1	Module with Master & 1-6 Row/Section switches
467984040S1	Extender Module (this part includes face labels for Row/Section 7-12 Row/Section 13/18 Row/Section 19-24)

IntelliAg® WSMT2



Boom Switch Module
467984030S1



Extended Shutoff Module
467984040S1



Planter Row Switch Module
467984264S1

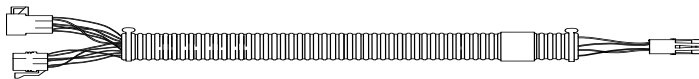

BSM Harness 24"
467980330



BSM CAN Harness Extension 60"
467980340

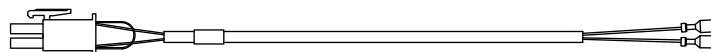

ESM Foot Switch Cable 96"
467984180



Case Tractor Cab Harness

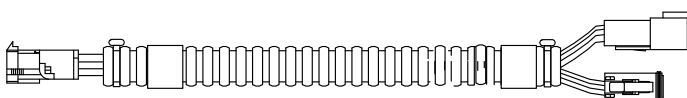

CFM to JD GS2 Cab Harness
467980335

Row/Boom Switch Module

Row/Boom Switch Module with (3) extended modules controls up to 24 boom on/off shutoff valves.

Row Switch Module with (3) extended modules controls up to 24 row shutoff clutches.

Switch modules placed in the cab allow each row/section to be controlled or use the master switch for all row/section on or off.

Row/Boom Switch Module Parts	
Part Number	Description
46798-4030S1	Row/Boom Switch Module (RSM/BSM) (1-6 row)
46798-4040S1	Extended Shut Off Module (ESM) (7-24 row)
46798-4264S1	Planter Row Switch Module
46798-0330	BSM Harness to Tractor Harness
46798-0340	BSM Harness 60" CAN Extension
46798-4180S1	ESM Foot Switch Cable (Liquid)
46798-0335	CFM to JD GS2 Cab Harness
46798-0339	RSM Harness to ISOBUS 9-pin in-cab Connector
46798-0626	BSM/ESM Mounting Bracket for use with 12" Virtual Terminal (Topcon X35)
46798-4160	BSM/ESM U-Mount Bracket (accommodates mounting 46798-4030S1 Boom Switch Module)

In-cab 9-pin ISOBUS mating connector

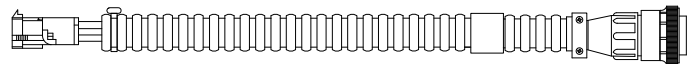
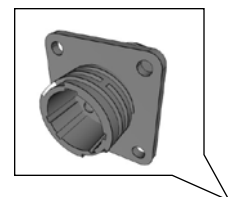

RSM Harness to ISOBUS 9-pin in-cab Connector
467980339

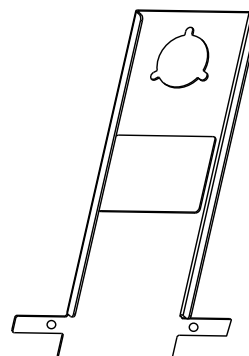

BSM/ESM Mounting Bracket (Topcon X35)
467980626

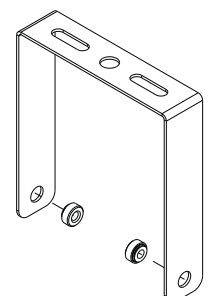

BSM U Mount Bracket
467984160

IntelliAg® WSMT2

Radar Y Harnesses

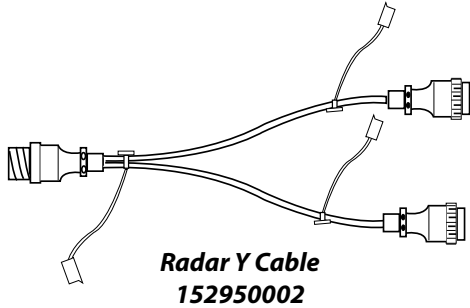

Adapter Harness	
Part Number	Description
15295-0002	Radar Y Cable Generic
45640-4670	Radar Y Cable for Case Maxum 5110-5240, MX90-170 Series, Steiger 9110-9390, 9210-9390 Series, Case STX 275-450 Series
45640-3030	Radar Y Cable for Caterpillar 65A, 65B, 75B Series
45640-4360S1	Radar Y Cable for 35, 45, 55, C, D, E Series
45640-2520S3	Radar Y Cable for John Deere 4xxx, 7xxx, 80xx Series
45640-2530S3	Radar Y Cable for John Deere 7600-8010T
45640-4810	Radar Y Cable for John Deere 8300 and 9400 Series

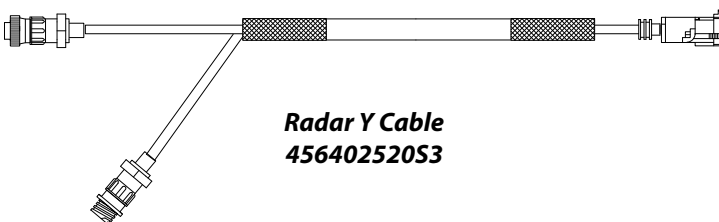
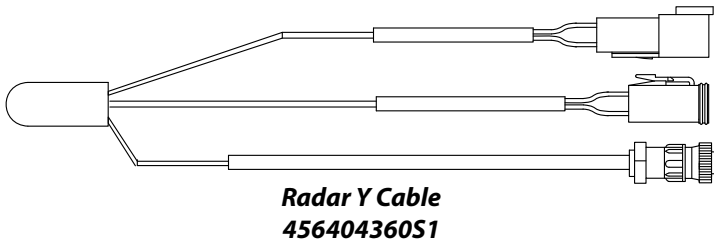
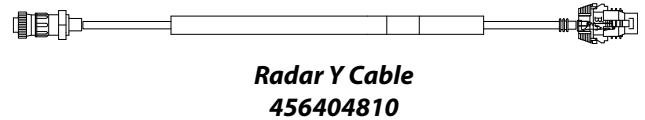
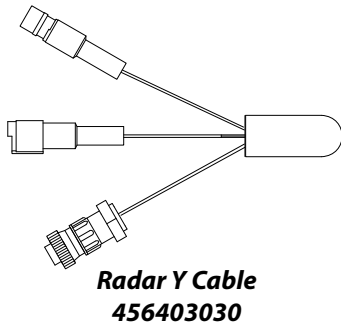
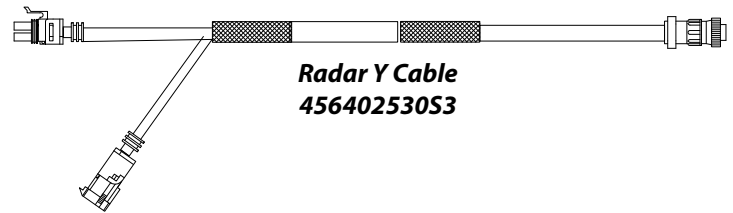
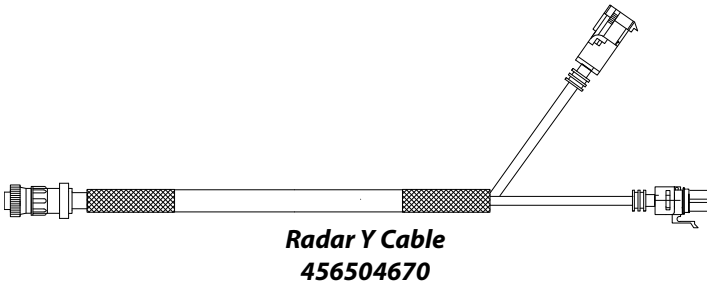

IntelliAg® WSMT2

Monitor and Control

Base System - Air Cart

- IntelliAg® Virtual Terminal Topcon X35
- Tractor harness for use with 12" Virtual Terminal
- System power harness with ISO hitch connector
- ISO master switch to control on/off
- Hitch extension harness
- ACC - WSMT2
- WSMT2 T harness
- Control harness for connection to valves and feedback sensors

Accessory Module WSMB



An accessory module connects to the Accessory Harness 467980205 to add up to 2 hopper, 2 air, and 2 RPM sensors.

ALTERNATIVE Daisy Chain Blockage Sensor System



Monitors seed and fertilizer flow on air seeder applications for blockage. Uses the Daisy Chain 2-way communication sensor for advanced diagnostics. Refer to page 38.

Vigilense® Sensor



Hopper Level Sensor



WSMTII-ACC



Air Pressure Sensor



Continental



WSMB used with Vigilense® Sensor



Lift Switch



Application Rate Sensor



Fan RPM Sensor

IntelliAg® WSMT2

Air Cart System Diagram

Air Cart Control Module

4 control channels can be set for granular seeding (pounds per acre) or fertilizer (pounds per acre) application plus NH3 control.

Accepts inputs from:

- 5 Hopper Level Sensors
- 4 Air Pressure Sensors
- 3 RPM Sensors
- 1 Implement Lift Switch
- 1 Ground Speed Sensor
- Optional Working Set Member can accept additional seed or blockage sensor inputs
- Optional Working Set Member output modules may be connected

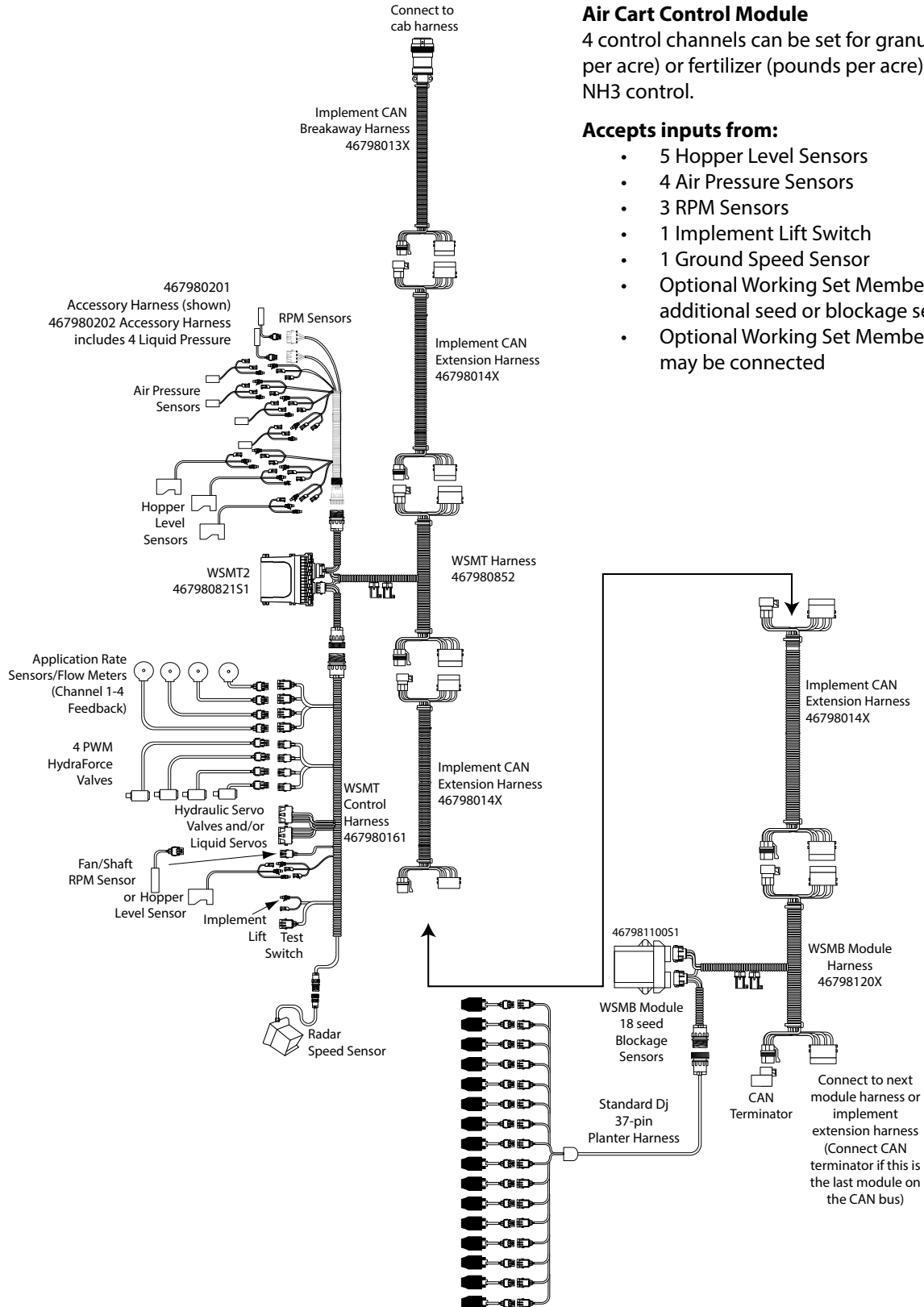

IntelliAg® WSMT2

*-0161 Control Harness/-0852 WSMT Harness/
-0201 Accessory Cable
-0852/-0161 use with ACC-WSMT2 and Material
Application Modules only*

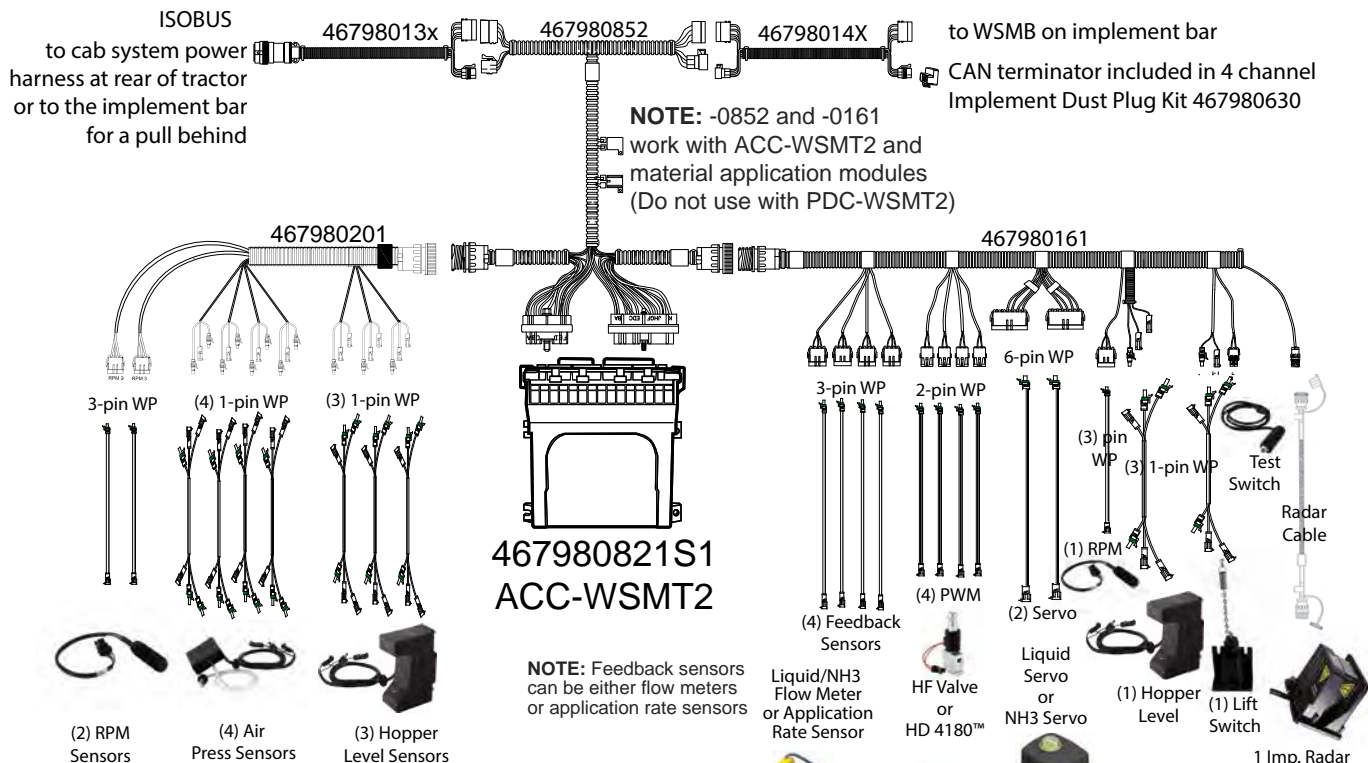

SYSTEM LIMITS

The ACC WSMT has 4 control channels:

- * Seeding (lbs/acre)
- * Granular (lbs/acre)
- * Liquid (gal/acre)
- * NH3 (lbs/acre)

SENSORS/SWITCHES

- 5 Hopper Level
- 4 Air Pressure
- 3 RPM
- 1 Ground Speed
- 1 Lift Switch

* ACC WSMT will not accept inputs directly from seed blockage sensors. A WSMB module is required accepting 18 rows per module.

IntelliAg® WSMT2

System Parts List

HITCH EXTENSIONS

Part Number	Description
467980134	Hitch Extension 6'
467980132	Hitch Extension 10'
467980136	Hitch Extension 15'
467980131	Hitch Extension 20'
467980133	Hitch Extension 30'
467980130	Hitch Extension 40'
467980135	Hitch Extension 50'

IMPLEMENT HARNESS

Part Number	Description
467980821S1	WSMT
467980852	WSMT Harness
467980142	CAN Extension 5'
467980141	CAN Extension 10'
467980140	CAN Extension 20'
467980143	CAN Extension 25'
467980144	CAN Extension 40'
467980146	CAN Extension 45'
467980630	4 Ch. Imp. Dust Plug Kit w/CAN Term.
110110099	Ty Wrap Bundle 100 14"
110011463	ACC User Manual
467980161	Control Harness
467980201	Accessory Input Harness
467980202	Accessory Input Harness +4 Liquid psi

APPLICATION RATE SENSOR

Part Number	Description
464360178S1	AR Sensor 360 1' Cable
464360176S1	AR Sensor 360 5' Cable
457141810	App. Rate 1" Coupler
457141850	App. Rate 1.25" Coupler
467092221	HD4180 to AR Sensor Coupler
457901810	3Pin WP Ext. Cable 15'
457901811	3Pin WP Ext. Cable 30'
457901812	3Pin WP Ext. Cable 45'

PULSE-WIDTH MODULATION CONTROLS 1-4

Part Number	Description
467092004S1	Hydraulic Valve HydraForce 4 GPM
467092008S1	Hydraulic Valve HydraForce 8 GPM
467092050S1	Hydraulic Valve HydraForce 25 GPM
467092200S1	HD4180 w/Integrated Valve
467980470	12 Ga. 2Pin WP Ext. Cable 15'
467980471	12 Ga. 2Pin WP Ext. Cable 20'
467980473	12 Ga. 2Pin WP Ext. Cable 30'
467980472	12 Ga. 2Pin WP Ext. Cable 40'

LIFT SWITCH AND RADAR

Part Number	Description
463720150S1	Implement Lift Switch
464820520S1	Lift Switch - Whisker Type
466820713	3-1Pin WP Ext. Cable 5'
466820712S1	3-1Pin WP Ext. Cable 10'
466820714	3-1Pin WP Ext. Cable 15'
466820710S3	3-1Pin WP Ext. Cable 20'
467831000S9	Radar III w/14' Cable & Mtg Brkt
439400024	Radar Extension 10'
439400065	Radar Extension 15'
439400064	Radar Extension 25'
464210515S1	Test Switch

HOPPER LEVEL SENSORS

Part Number	Description
466820720S3	Hopper Level Sensor
466820721S1	Hopper Level Sensor w/ 1/2" Bushing
466820713	3-1Pin WP Ext. Cable 5'
466820712S1	3-1Pin WP Ext. Cable 10'
466820714	3-1Pin WP Ext. Cable 15'
466820710S3	3-1Pin WP Ext. Cable 20'

AIR PRESSURE 1-4

Part Number	Description
466820920S1	Air Pressure Sensor
466820922S1	Air Pressure Sensor w/ 1/2" Bushing
466820713	3-1Pin WP Ext. Cable 5'
466820712S1	3-1Pin WP Ext. Cable 10'
466820714	3-1Pin WP Ext. Cable 15'
466820710S3	3-1Pin WP Ext. Cable 20'

RPM SENSORS

Part Number	Description
463500030S1	Hall Effect Sensor RPM (Smooth)
466970014S1	Hall Effect Sensor RPM (Threaded)
459680922	Extension Cable 3Pin WP 15'

FLOW METERS

Part Number	Description
PM00370018S1	Flow Meter 1/2"
PM00370023S1	Flow Meter 3/4"
PM00370030S1	Flow Meter 1"
PM00370040S1	Flow Meter 1.5"
PM00370048S1	Flow Meter 2"
PM00370068S1	Flow Meter 3"
PM00370088S1	Flow Meter 4"
PMNPT70116S1	SS Flow Meter 1/2"
PMNPT70121S1	SS Flow Meter 3/4"
PMNPT70126S1	SS Flow Meter 1"
PMNPT70136S1	SS Flow Meter 1-1/2"
PMNPT70146S1	SS Flow Meter 2"
457901810	3Pin WP Ext. Cable 15'
457901811	3Pin WP Ext. Cable 30'
457901812	3Pin WP Ext. Cable 45'

LIQUID VALVE AND ACTUATOR (LIQUID FLOW CONTROL)

Part Number	Description
467095010	Valve & Actuator Assy. 3/8" 2-Way Stainless Steel
467095220	Valve & Actuator Assy. 3/8" 3-Way Stainless Steel
467095020	Valve & Actuator Assy. 1/2" 2-Way Stainless Steel
467095030	Valve & Actuator Assy. 3/4" 2-Way Poly
467095280	Valve & Actuator Assy. 1" 2-Way Poly
467095290	Valve & Actuator Assy. 1" 2-Way Stainless Steel
467095050	Valve & Actuator Assy. 1-1/2" 3-Way Poly
467095140	Valve & Actuator Assy. 1-1/2" 3-Way Stainless Steel
467095150	Valve & Actuator Assy. 2" 2-Way Stainless Steel
467095160	Valve & Actuator Assy. 2" 3-Way Stainless Steel
467095170	Valve & Actuator Assy. 3" 2-Way Stainless Steel
457901820	6Pin WP Extension Cable 15'
457901821	6Pin WP Extension Cable 30'

ELECTRIC MOTOR DRIVER

Part Number	Description
467980490	High Current Electric Motor Harness
467980390	Power Harness (High current > than 10 A)

IntelliAg® WSMT2

-0160 Control Harness and -0490 Electric Motor Drive Cable

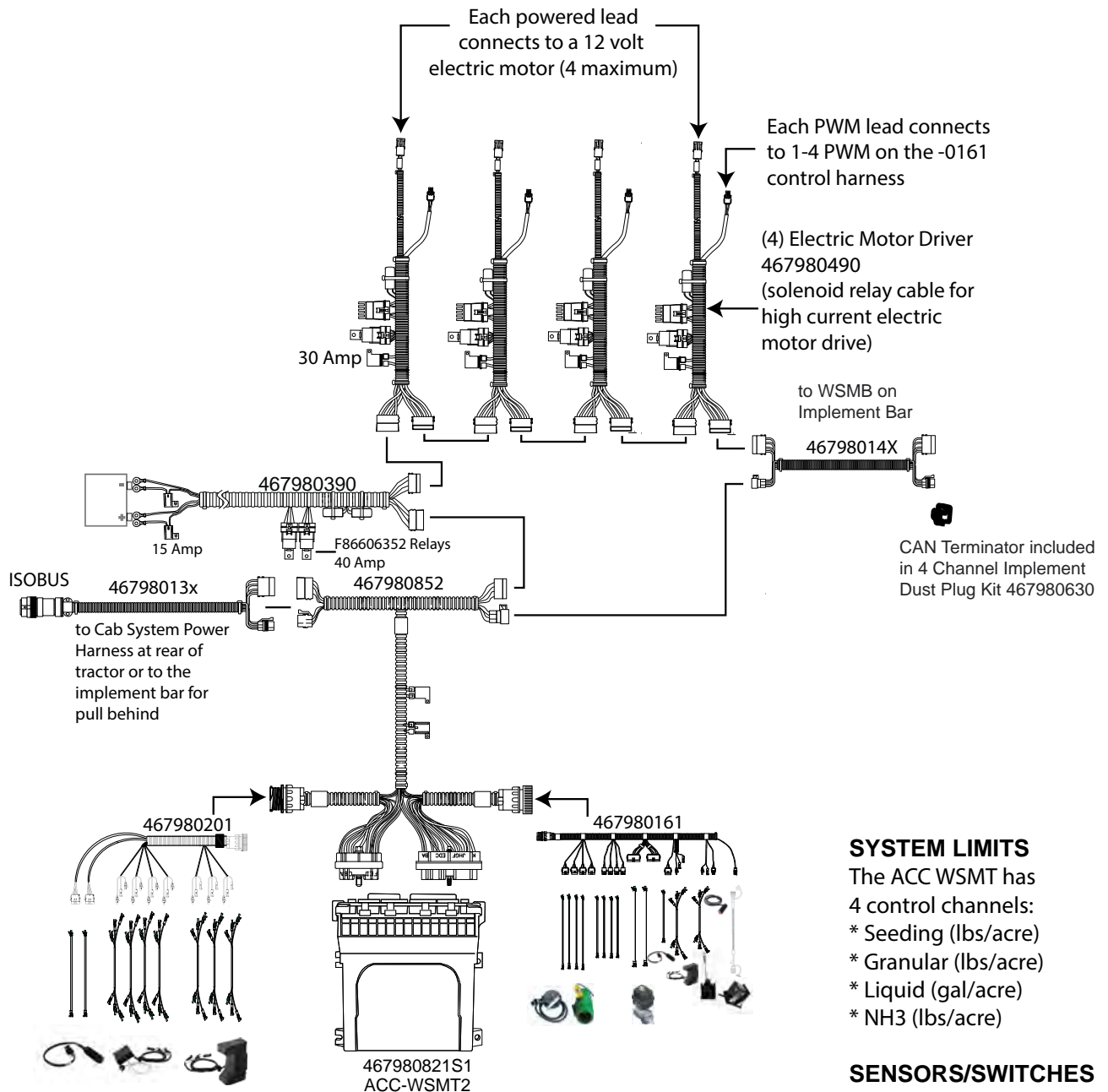

SYSTEM LIMITS
The ACC WSMT has 4 control channels:
* Seeding (lbs/acre)
* Granular (lbs/acre)
* Liquid (gal/acre)
* NH3 (lbs/acre)

SENSORS/SWITCHES
5 Hopper Level
4 Air Pressure
3 RPM
1 Ground Speed
1 Lift Switch

NOTE: Feedback sensors can be either flow meters or application rate sensors

ACC WSMT will not accept inputs directly from seed sensors. A WSMB module is required accepting 18 rows per module.

IntelliAg® WSMT2

System Parts List

APPLICATION RATE SENSORS

Part Number	Description
464360178S1	AR Sensor 360 1' Cable
464360176S1	AR Sensor 360 5' Cable
457141810	App. Rate 1" Coupler
457141850	App. Rate 1.25" Coupler
457901810	3Pin WP Ext. Cable 15'
457901811	3Pin WP Ext. Cable 30'
457901812	3Pin WP Ext. Cable 45'

PULSE WIDTH MODULATION CONTROLS

Part Number	Description
467980390	ADX Power Harness
467980490	Electric Motor Driver Harness
467980470	12 Ga. 2Pin WP Ext. Cable 15'
467980471	12 Ga. 2Pin WP Ext. Cable 20'
467980473	12 Ga. 2Pin WP Ext. Cable 30'
467980472	12 Ga. 2Pin WP Ext. Cable 40'

OPTIONAL SENSORS

Part Number	Description
463720150S1	Implement Lift Switch
464820520S1	Lift Switch - Whisker Type
466820720S3	Hopper Level Sensor
466820721S1	Hopper Level Sensor w/ 1/2" Bushing
466820920S1	Air Pressure Sensor
466820922S1	Air Pressure Sensor w/ 1/2" Bushing
466820713	3-1Pin WP Ext. Cable 5'
466820712S1	3-1Pin WP Ext. Cable 10'
466820714	3-1Pin WP Ext. Cable 15'
466820710S3	3-1Pin WP Ext. Cable 20'
467831000S9	Radar III w/14' Cable & Mtg Brkt
439400024	Radar Extension 10'
439400064	Radar Extension 25'
464210515S1	Test Switch

RPM SENSORS

Part Number	Description
463500030S1	RPM (Smooth)
466970014S1	RPM (Threaded)
459680922	Extension Cable 3Pin WP 15'

FLOW METERS

Part Number	Description
PM00370018S1	Flow Meter 1/2"
PM00370023S1	Flow Meter 3/4"
PM00370030S1	Flow Meter 1"
PM00370040S1	Flow Meter 1.5"
PM00370048S1	Flow Meter 2"
PM00370068S1	Flow Meter 3"
PM00370088S1	Flow Meter 4"
PMNPT70116S1	SS Flow Meter 1/2"
PMNPT70121S1	SS Flow Meter 3/4"
PMNPT70126S1	SS Flow Meter 1"
PMNPT70136S1	SS Flow Meter 1-1/2"
PMNPT70146S1	SS Flow Meter 2"
457901810	3Pin WP Ext. Cable 15'
457901811	3Pin WP Ext. Cable 30'
457901812	3Pin WP Ext. Cable 45'

LIQUID VALVE AND ACTUATOR

Part Number	Description
467095010	Valve & Actuator Assy. 3/8" 2-Way Stainless Steel
467095220	Valve & Actuator Assy. 3/8" 3-Way Stainless Steel
467095020	Valve & Actuator Assy. 1/2" 2-Way Stainless Steel
467095030	Valve & Actuator Assy. 3/4" 2-Way Poly
467095280	Valve & Actuator Assy. 1" 2-Way Poly
467095290	Valve & Actuator Assy. 1" 2-Way Stainless Steel
467095050	Valve & Actuator Assy. 1-1/2" 3-Way Poly
467095140	Valve & Actuator Assy. 1-1/2" 3-Way Stainless Steel
467095150	Valve & Actuator Assy. 2" 2-Way Stainless Steel
467095160	Valve & Actuator Assy. 2" 3-Way Stainless Steel
467095170	Valve & Actuator Assy. 3" 2-Way Stainless Steel
457901820	6Pin WP Extension Cable 15'
457901821	6Pin WP Extension Cable 30'

ELECTRIC MOTOR DRIVER

Part Number	Description
467980490	High Current Electric Motor Harness
467980390	Power Harness (High current > than 10 A)

IntelliAg® WSMT2

*Row Harnesses
Add Additional Rows*

37-pin CPC WSMB Harness

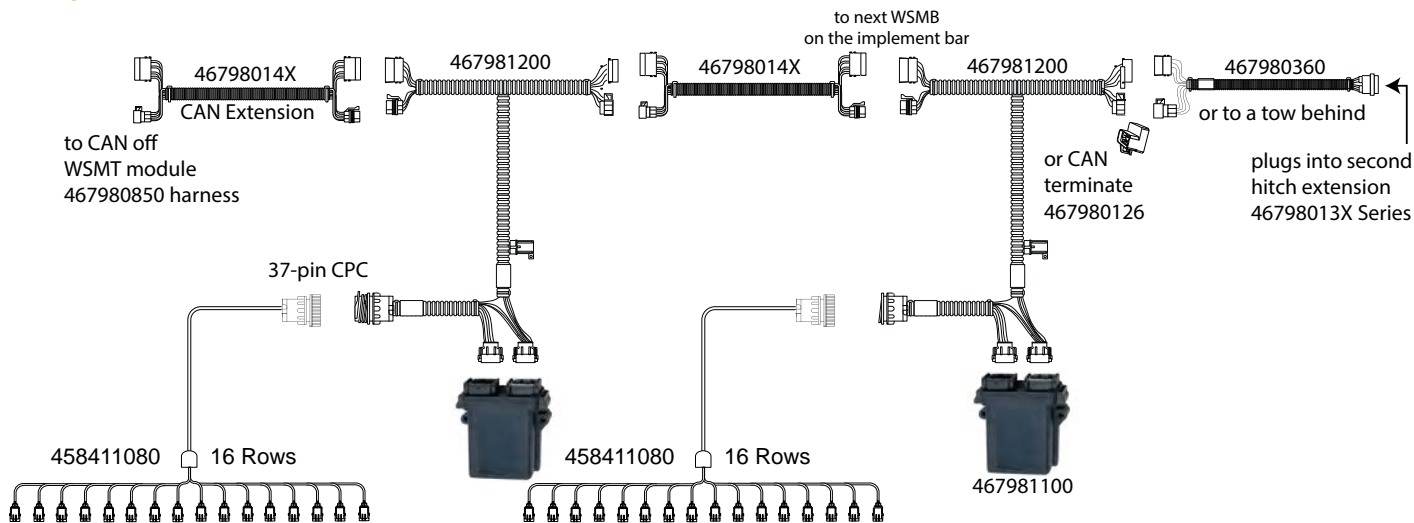

SYSTEM LIMITS
 18 Seed Rows per WSMB
 12 WSMB modules per ACC WSMT
 10 WSMB modules per PDC WSMT

SE Style WSMB Harness

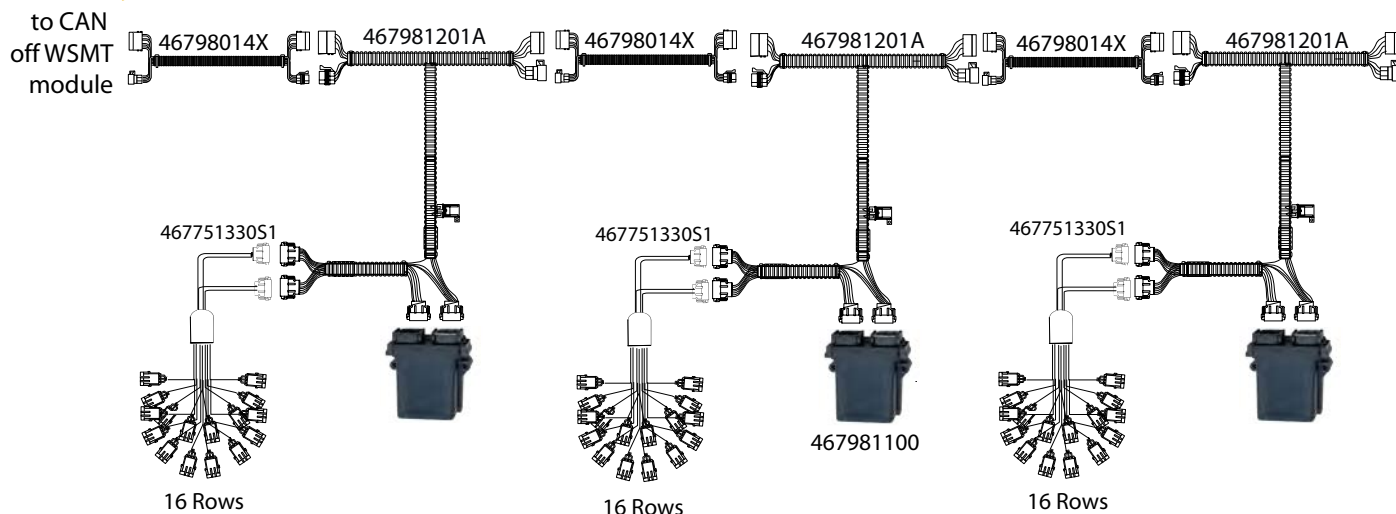

IntelliAg® WSMT2

System Parts List

HITCH EXTENSIONS

Part Number	Description
467980134	Hitch Extension 6'
467980132	Hitch Extension 10'
467980136	Hitch Extension 15'
467980131	Hitch Extension 20'
467980133	Hitch Extension 30'
467980130	Hitch Extension 40'
467980135	Hitch Extension 50'

IMPLEMENT HARNESSING

Part Number	Description
467981100S1	WSMB
467981201	WSMB Harness
467980142	CAN Extension 5'
467980141	CAN Extension 10'
467980140	CAN Extension 20'
467980143	CAN Extension 25'
467980144	CAN Extension 40'
467980146	CAN Extension 45'
467980126	CAN Terminator

CAN TO HITCH CONNECTOR HARNESS

THIS HARNESS ACCOMMODATES DISCONNECTION OF A TOW BEHIND.

Part Number	Description
467980360	Rear Implement Hitch Harness 3'
467980361	Rear Implement Hitch Harness IBBC 6'
467980362	Rear Implement Hitch Harness IBBC 20'
467980363	Rear Implement Hitch Harness IBBC 25'

ROW HARNESS (37-PIN CPC)

Part Number	Description
458410530	4 Row Planter Harness
458410550	6 Row Planter Harness
458410570	8 Row Planter Harness
458410590	12 Row Planter Harness
458411080	16 Row Planter Harness (in diagram)
459680960	12 Row Y Cable to use 2-6 Row Pltr Hrn
459680950	16 Row Y Cable to use 2-8 Row Pltr Hrn
458410600	16 Row 2-8 Row Pltr Hrn w/16 Row Y
459680940	24 Row Y Cable to use 2-12 Row Hrn
467980445	JD 32 Row Reverse Y Harness
467980446	32 Row Reverse Y Harness

ROW HARNESS EXTENSIONS

Part Number	Description
458410810	6 ft. Extension (16 row)
459680320	15 ft. Extension (16 row)
459680321	30 ft. Extension (16 row)
458410820	15 ft. Extension (32 row)
458410790	30 ft. Extension (32 row)

ROW HARNESS (SE STYLE)

Part Number	Description
Used In This Example:	
467980280	18 Row SE style Air Cart
Other SE style Harnesses:	
467751300S1	12 Row 7.5"
467751301S1	12 Row 15"
467751302S1	12 Row 30"
467751310S1	16 Row 7.5"
467751311S1	16 Row 15"
467751312S1	16 Row 30"
467751320S1	12 Row Air Cart Tower
467751330S1	16 Row Air Cart Tower
467980280	18 Row Air Cart Tower

SEED SENSOR EXTENSIONS

Part Number	Description
459680920	3' Sensor Extension 3Pin WP
459680923S1	4' Sensor Extension 3Pin WP
459680921	6' Sensor Extension 3Pin WP
459680922	15' Sensor Extension 3Pin WP

SEED AND BLOCKAGE SENSORS

Part Number	Description
467420701S1	Vigilense 25 mm
467420702S1	Vigilense 25 mm with SS Insert
467420711S1	Vigilense 32 mm
467420712S1	Vigilense 32 mm with SS Insert
467420720S1	Vigilense 45 mm
467420721S1	Vigilense 45 mm with SS Insert
467700090S1	Monosem Mecca 2000
467700100S1	Monosem MS Vegetable
467700220S1	Stanhay Dart II
467760010S1	Case ASM Hi-Rate Sensor Only

IntelliAg® WSMT2



**WSMT2
Module**

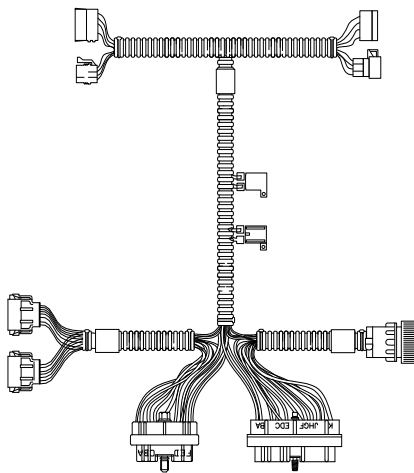

**WSMT Harness
467980851**

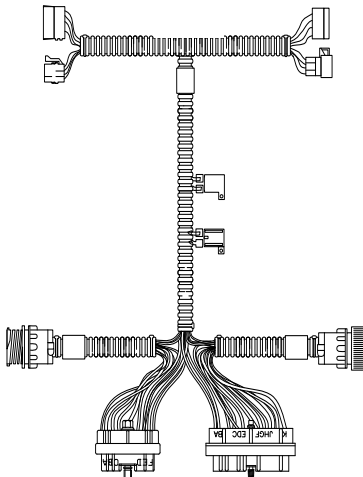

**WSMT Harness
467980850 and -0852**



**Cab to Implement Harness Hitch Extension
46798013X**

Working Set Master Module (WSMT2)

The Working Set Master Module (WSMT2) houses the system's primary interface device. All system parameters, constants, and memory are stored in the WSMT and controls the application of material by interfacing with proportional hydraulic valves and feedback sensors. Several WSMT modules are available for a variety of applications.

Working Set Master Module	
Part Number	Description
46798-0821S1	Module, ACC-WSMT2 (Aircart Control)
46798-0630	4 Channel Implement Dust Plug Kit with Terminators
11011-0099	Ty Wrap Bundle 100 14 in.

Working Set Master Harness

WSMT Harnessing	
Part Number	Description
46798-0851	WSMT Harness Seed Manager SE style without APER (PDC)
46798-0852	WSMT Harness with 37-pin CPC with APER (Material Application)

NOTE: SE style harnesses have 1 gray and 1 black 12-pin Deutsch DT connector.

Cab to Implement Harness Hitch Extension

Tractor Cab to Implement Harness Hitch Extensions	
Part Number	Description
46798-0134	6 ft. Hitch Extension ISO system CAN
46798-0132	10 ft. Hitch Extension ISO system CAN
46798-0136	15 ft. Hitch Extension ISO system CAN
46798-0131	20 ft. Hitch Extension ISO system CAN
46798-0133	30 ft. Hitch Extension ISO system CAN
46798-0130	40 ft. Hitch Extension ISO system CAN
46798-0135	50 ft. Hitch Extension
46798-0457	40 ft. Hitch to Hitch Extension

Implement Kit

IAACCIMPKIT Air Cart Control Implement Kit consists of the following	
Part Number	Description
46798-0821S1	Module, ACC-WSMT2 (Aircart Control)
46798-0852	WSMT Harness with 37-pin CPC with APER (Material Application)
46798-0161	Control Harness
46798-0630	4 Channel Implement Dust Plug Kit with Terminators
11001-1514	Operator's Manual User Level 2
11001-1515	Operator's Manual User Level 1

IntelliAg® WSMT2

WSMT2 Harnesses (Control Channels/
Accessory Inputs)

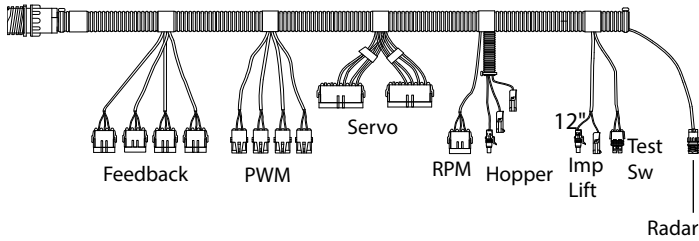

Harness 4 Channel
467980161

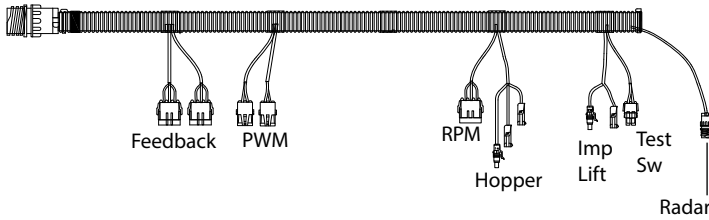

Harness 2 Channel
467980162

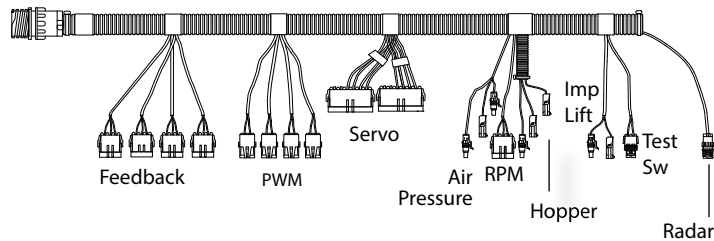

Harness with RPM/Air Pressure
467980164

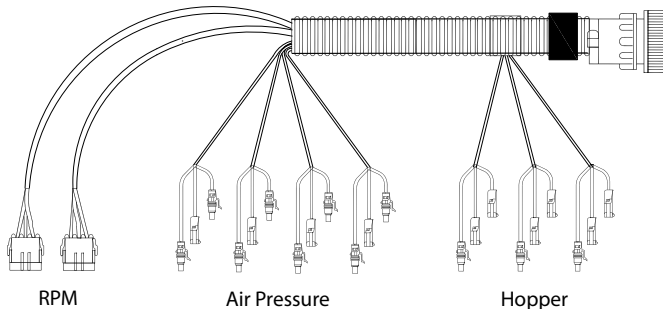

Harness with RPM/Air Pressure/Hopper
467980201

PM Style Control Harnesses	
Part Number	Description
46798-0161	WSMT Material Application 4 Ch Actuator Harness with APER (app error rate)
46798-0162	WSMT Air Cart Control 2 Ch Actuator/Sensor Harness
46798-0164	WSMT 4 Ch Actuator Harness with RPM or Air Pressure
46798-0201	Air Cart Control WSMT Input Harness (2 RPM, 4 Air Pressure, 3 Hopper Level)
46798-0202	Air Cart Control WSMT Input Harness (2 RPM, 4 Air Pressure, 4 Liquid, 3 Hopper Level)

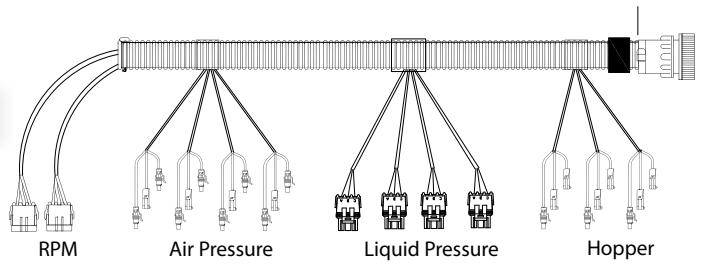

Harness with RPM/Air Pressure/Liquid/Hopper
467980202

IntelliAg® WSMT2



**WSMB
Module**

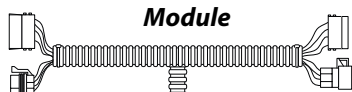

WSMB Harness row connection has a 37-pin Amp CPC connector.

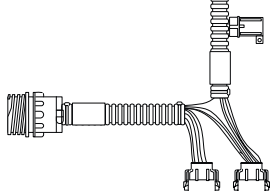

**WSMB Harness
467981200**

Connects to Seed Manager® SE planter row harness for seed sensor inputs.

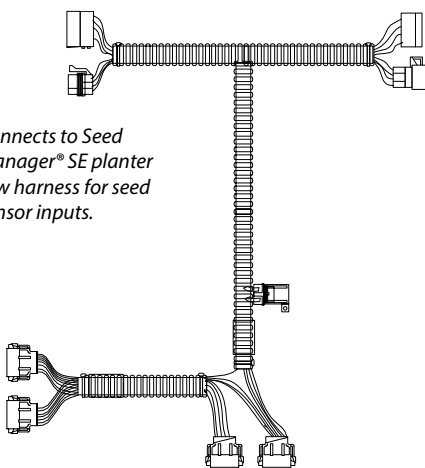

**WSMB Harness SE Style
467981201A**



**WSMB Extension Harness
46798014X**

Working Set Member Module

The Working Set Member Module (WSMB) is an auxiliary to the Working Set Master Module (WSMT). Each WSMB can accept up to 18 rows of seed sensors and passes information direct to the WSMT. Up to 11 WSMB's can be installed to monitor up to 214 rows. The flexible design allows for installation virtually anywhere on the implement.

Working Set Member Module (WSMB)	
Part Number	Description
46798-1100S1	WSMB Module (18 seed rows)

WSMB Harness

WSMB Harnesses	
Part Number	Description
46798-1200	WSMB Harness to 37-pin CPC Planter Row Harness (connects to 46798-1100S1)
46798-1201A	WSMB Harness Accessory T Harness (connects to 46798-1100S1)

NOTE: WSMB Harness SE style row connection has 1 gray and 1 black, 12-pin Deutsch DT connector.

WSMB CAN Extension Harness

WSMB Harnesses	
Part Number	Description
46798-0142	WSMB Extension 5 ft.
46798-0141	WSMB Extension 10 ft.
46798-0140	WSMB Extension 20 ft.
46798-0143	WSMB Extension 25 ft.
46798-0144	WSMB Extension 40 ft.
46798-0146	WSMB Extension 45 ft.

IntelliAg® WSMT2

CAN to Hitch Connector Harnesses



Rear Implement Hitch Harness (Deutsch)
46798-0360



Rear Implement Hitch Harness (IBBC)
467980361



Rear Implement Hitch Harness (IBBC)
467980362



Rear Implement Hitch Harness (IBBC)
467980363

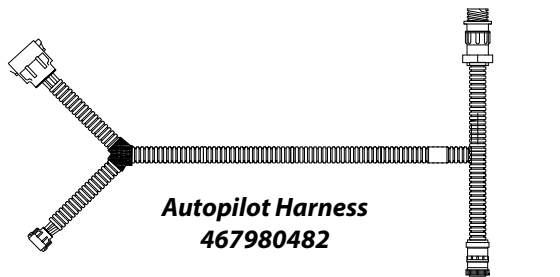

Autopilot Harness
467980482

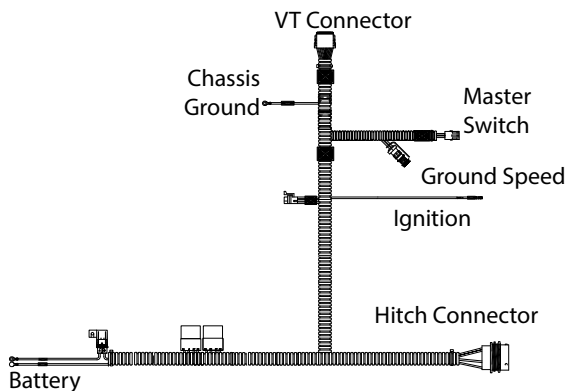

European ISO Tractor Harness
467980128

Harness accommodates disconnection between implement and tow-behind aircart to second hitch extension.

Rear Implement Hitch Harness	
Part Number	Description
46798-0360	Rear Implement Hitch Harness with Deutsch 9-pin (CAN to Hitch) 3 ft.
46798-0361	Rear Implement Hitch Harness with IBBC 9-pin (CAN to Hitch) 6 ft.
46798-0362	Rear Implement Hitch Harness with IBBC 9-pin 20 ft.
46798-0363	Rear Implement Hitch Harness with IBBC 9-pin 25 ft.

Adapter Harnesses

Adapter Harness	
Part Number	Description
46798-0490	Electric Motor Driver (solenoid relay cable for high current electric motor drive)
46798-0128	European ISO Tractor Harness (short)
46798-0390	CAN Power Y Cable (used with 46798-0490)

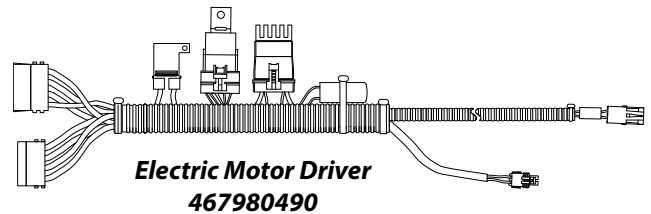

Electric Motor Driver
467980490

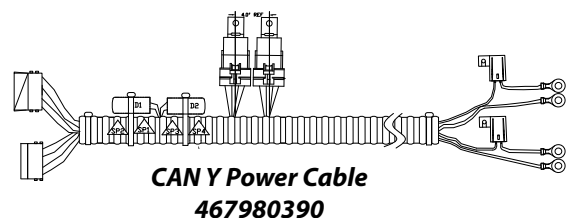

CAN Y Power Cable
467980390

IntelliAg® WSMT2
WSMB Output Module

Output Shutoff Module
467982001S1

A WSMB Output Module communicates with the Row and Boom Switch Module for section on/off control.

Row Shutoff Parts	
Part Number	Description
46798-2001S1	Output Shutoff Module
46798-3100	Liquid Boom Shutoff Harness (6 Boom/3-Wire Shutoff)
46798-3101	Liquid Boom Shutoff Harness (6 Boom/2-Wire Shutoff) (used with non-DICKEY-john® Valves and 464820510)
46482-0510S1	Solenoid Driver (plugs into 46798-3501 and -3101 for current >2 Amp)

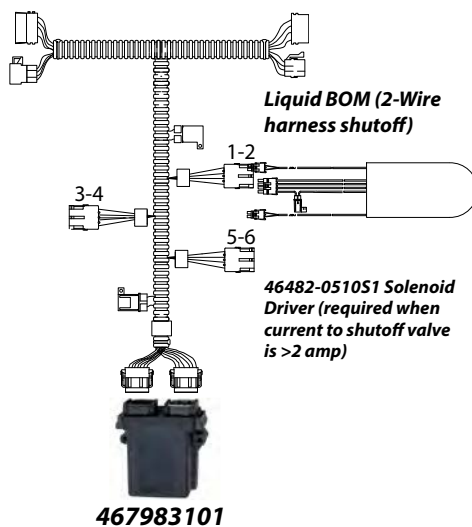
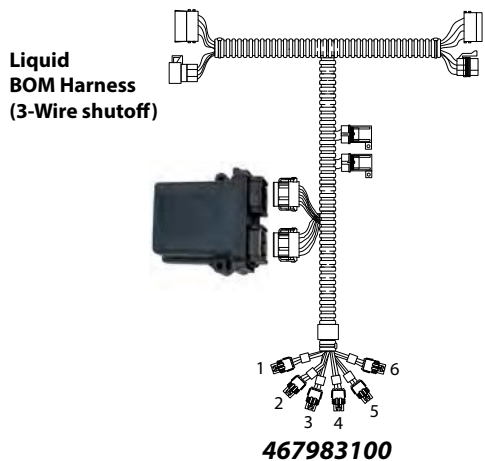

IntelliAg® WSMT2

Boom Switch Module



Boom Switch Module



Extended Shutoff Module

Boom Switch Module controls up to 24 boom on/off shutoff valves.

Switch modules placed in the cab allow each row/section to be controlled or use the master switch for all row/section on or off.

Boom Switch Module Parts	
Part Number	Description
46798-4030S1	Boom Switch Module (BSM) (1-6 row)
46798-4040S1	Extended Shut Off Module (ESM) (7-24 row)
46798-4150	BSM/ESM Mounting Bracket (mounts 4 total) for use with 5" virtual terminal (AI-50)
46798-4160	BSM/ESM U-Mount Bracket (accommodates mounting 46798-4030S1 Boom Switch Module)
46798-0330	BSM Harness to Tractor Harness
46798-0340	BSM Harness 60" CAN Extension
46798-4180S1	ESM Foot Switch Cable (Liquid)
46798-0625S1	BSM/ESM Mounting Bracket for use with 10" Virtual Terminal (AI-100)
46798-0626S1	BSM/ESM Mounting Bracket for use with 12" Virtual Terminal (Topcon X35)



BSM Harness 24"
467980330



BSM CAN Harness Extension 60"
467980340

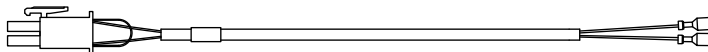

ESM Foot Switch Cable 96"
467984180



Case Tractor Cab Harness 24"
467980330

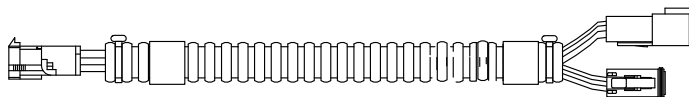

CFM to JD GS2 Cab Harness
467980335

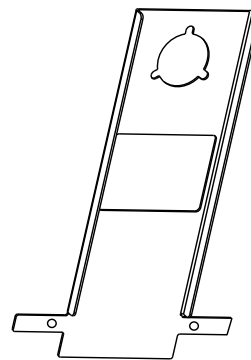

BSM/ESM Mounting Bracket (Topcon X35) 467980626

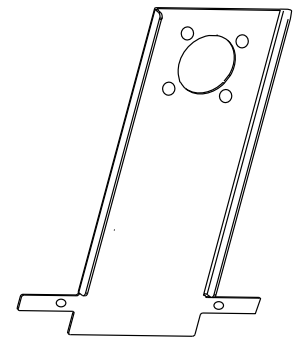

BSM/ESM Mounting Bracket (AI-100) 467980625

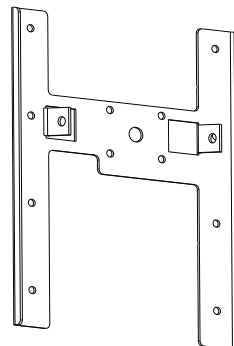

BSM/ESM Mounting Bracket 467984150

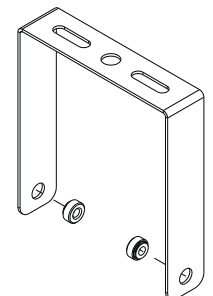

BSM U Mount Bracket 467984160

Daisy Chain Blockage Detection System



Daisy Chain Sensor

The Daisy Chain blockage detection system monitors seed and fertilizer flow on air seeder applications to determine if distribution hoses are open or blocked. Sensors are connected to each other in a serial chain layout contained within the loop.

The system is designed with redundant communication between sensors so that any defective sensor within the system does not shutdown the entire blockage system. Blockage full screen alarms quickly pinpoint exact sensor blockage, communication, or wiring issues to remove guesswork from troubleshooting.

One module can connect to 1 or 2 loops. A maximum of 4 modules and 8 loops connect to sensors that communicate blockage and system status for display on the virtual terminal.

The tramline feature alerts the daisy chain module to ignore sensors if blockage is found on any sensors that are configured as tramline.

The blockage system is compatible with any ISO virtual terminal including DICKEY-john®, Case, John Deere, and AGCO terminals.



Daisy Chain Module

Features:

- Monitors up to 4 modules and a total of 8 loops
- Each module can interface with a maximum of 2 sensor loops
- Maximum number of sensors per loop is 54 for a total of 432 sensors
- Tramline monitoring of seed or fertilizer with up to 192 sensors assigned to tramlining
- Full screen alarms pinpoint blockage or system issues for quick resolution
- Bi-directional communication lines between sensors and modules
- System can continue to monitor sensor blockage with 1 line failure
- Three system tests (communication, power, and sensor provide immediate feedback of system status)
- Additional rows and blockage sensors can be added later with minimal harnessing changes

Daisy Chain Blockage Detection System	
Part Number	Description
46798-8670S1	Daisy Chain Sensor 32 mm
46798-8840S1	Daisy Chain Sensor 50 mm
46798-8865S1	Daisy Chain Sensor 45 mm
46798-8885S1	Daisy Chain Sensor 25 mm
46798-8690S1	Sensor Module
11001-1620B	Daisy Chain Blockage System Operator's Manual

Daisy Chain Blockage Detection System



Loop A/B Harness



Module Harness ISO 1 Loop



Module Harness ISO 2 Loop



Module Extension Harness 6m or 10m



CAN Bus Adapter Harness

46798-8752 Fly Leads

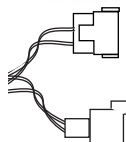

46798-8751 Packard connectors

Daisy Chain Blockage Detection System	
Part Number	Description
46798-8749	Loop A/B Harness
46798-8720	Module Harness ISO 1 Loop
46798-8730	Module Harness ISO 2 Loop
46798-8741	Module Extension Harness 6 Meter
46798-8740	Module Extension Harness 10 Meter
46798-8761	Terminator
46798-8759	Lift Switch/Tramline Connector Kit (includes 1 Deutsch connector, 1 Deutsch wedge, 5 Deutsch terminals, and 10 Deutsch cavity plugs)
46798-8751	CAN Bus Adapter Harness with Packard connectors
46798-8752	CAN Bus Adapter Harness with fly wire leads



Terminator

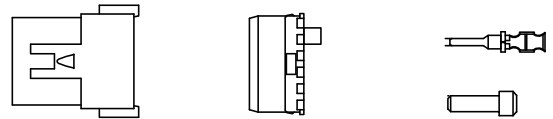

Lift Switch/Tramline Connector Kit

Lift Switch/Tramline Connector Kit Pinout	
1	12V Power
2	12V Accessory
3	Accessory Ground Out
4	Accessory Ground
5	Input 5
6	Input 7 Lift Switch
7	Input 3
8	Input 1
9	Ground Speed
10	Input 2
11	Input 4
12	Input 6

Typical Installation

Daisy Chain Blockage Detection System

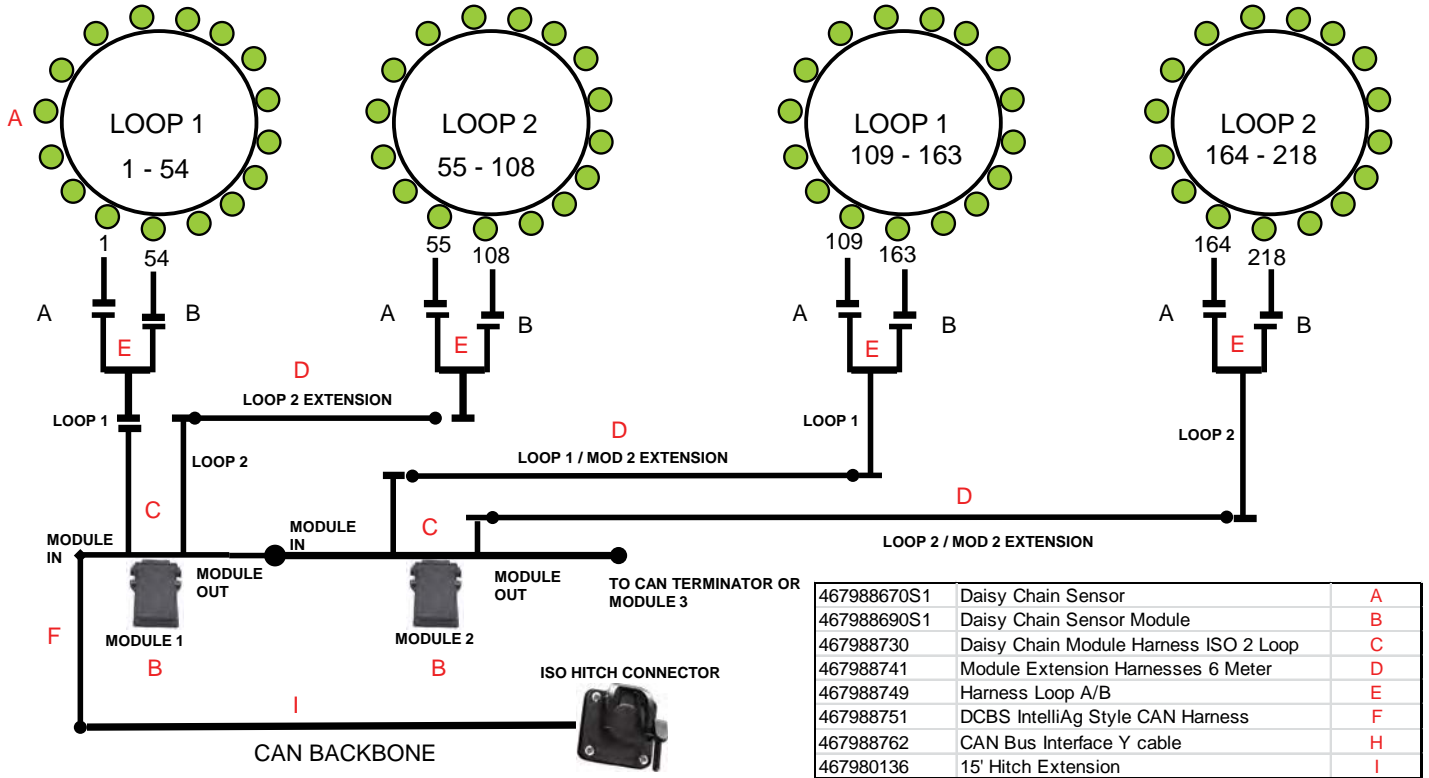

Alternate Installation

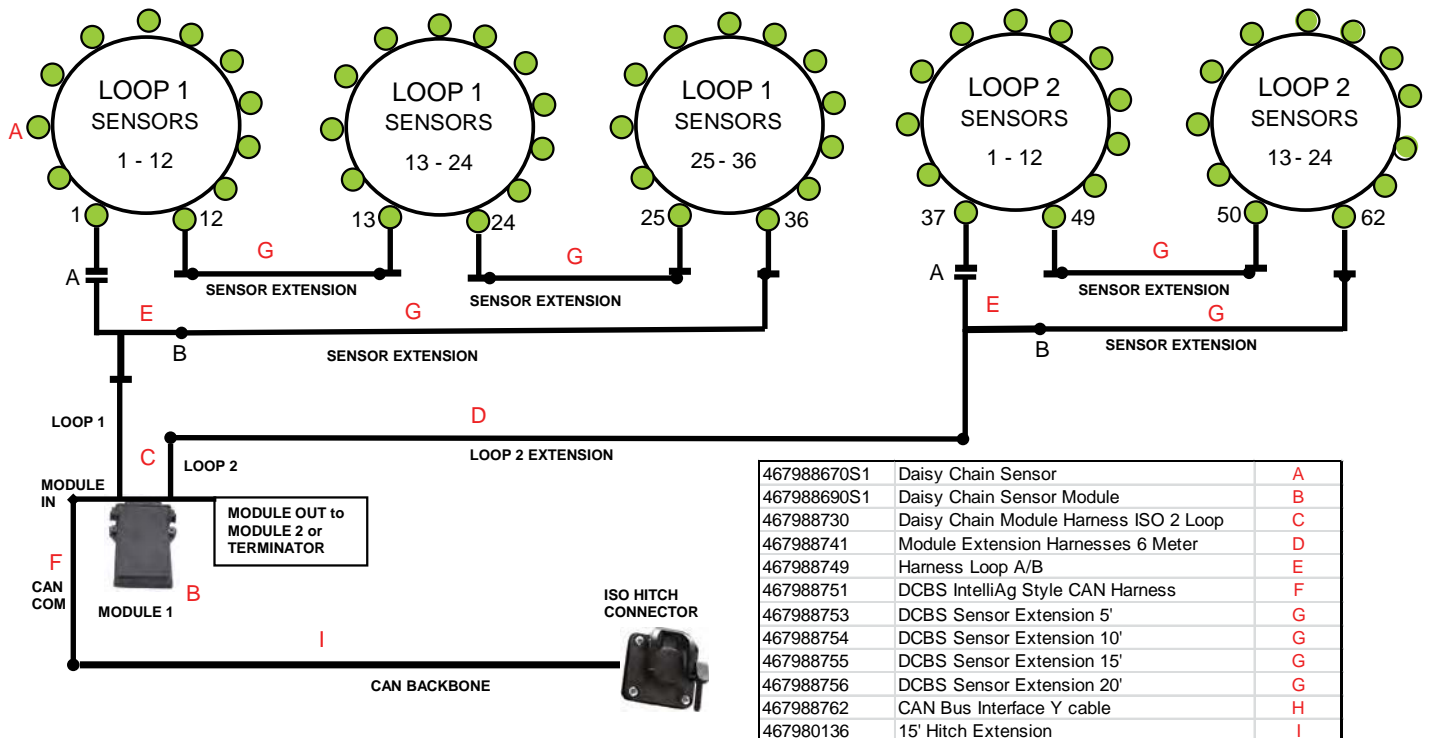

IntelliAg® WSMT2

Radar Y Harnesses

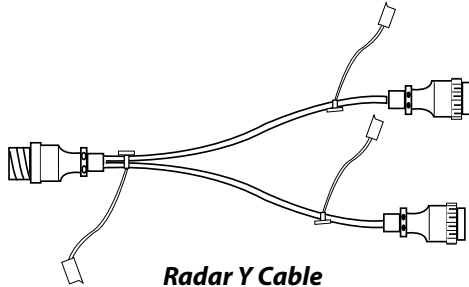

**Radar Y Cable
152950002**

Adapter Harness	
Part Number	Description
15295-0002	Radar Y Cable for Case Magnum 7110-8950 Series
45640-4670	Radar Y Cable for Case Maxum 5110-5240, MX90-170 Series, Steiger 9110-9390, 9210-9390 Series, Case STX 275-450 Series
45640-3030	Radar Y Cable for Caterpillar 65A, 65B, 75B Series
45640-4360S1	Radar Y Cable for 35, 45, 55, C, D, E Series
45640-2520S3	Radar Y Cable for John Deere 4xxx, 7xxx, 80xx Series
45640-2530S3	Radar Y Cable for John Deere 7600-8010T
45640-4810	Radar Y Cable for John Deere 8300 and 9400 Series

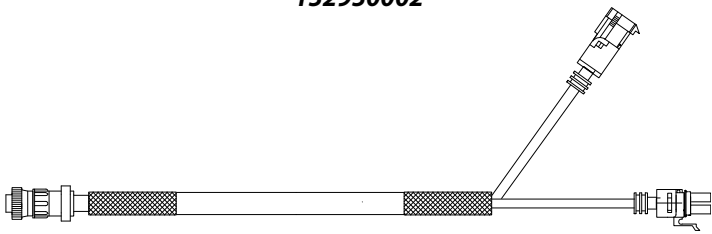

**Radar Y Cable
456504670**



**Radar Y Cable
456402530S3**

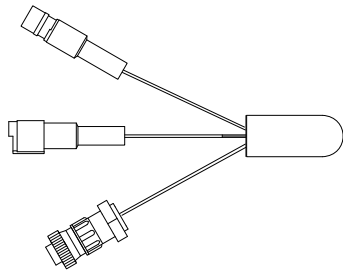

**Radar Y Cable
456403030**

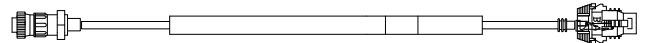

**Radar Y Cable
456504810**

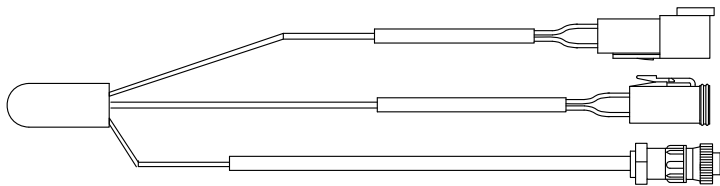

**Radar Y Cable
456404360S1**



**Radar Y Cable
456402520S3**

IntelliAg® WSMT2

Monitor and Control

Base System - Granular

- IntelliAg Virtual Terminal Topcon X35
- Tractor harness for use with virtual terminal
- System power harness with ISO hitch connector
- ISO master switch to control on/off
- Hitch extension harness
- WSMT2 SPDR module
- WSMT2 T harness
- Control harness for connection to valves and feedback sensors

Boom Output Module



Controls boom shutoff section valves.



IntelliAg® WSMT2

Spreader Control System Diagram

Granular Control Module

4 Control channels can be set for Granular Fertilizer (pounds per acre) or RPM control.

Accepts inputs from:

- 3 Hopper Level Sensors
- 3 RPM Sensors
- 4 Feedback Sensors
- 4 PWM and/or Servos
- Gate Height Sensors

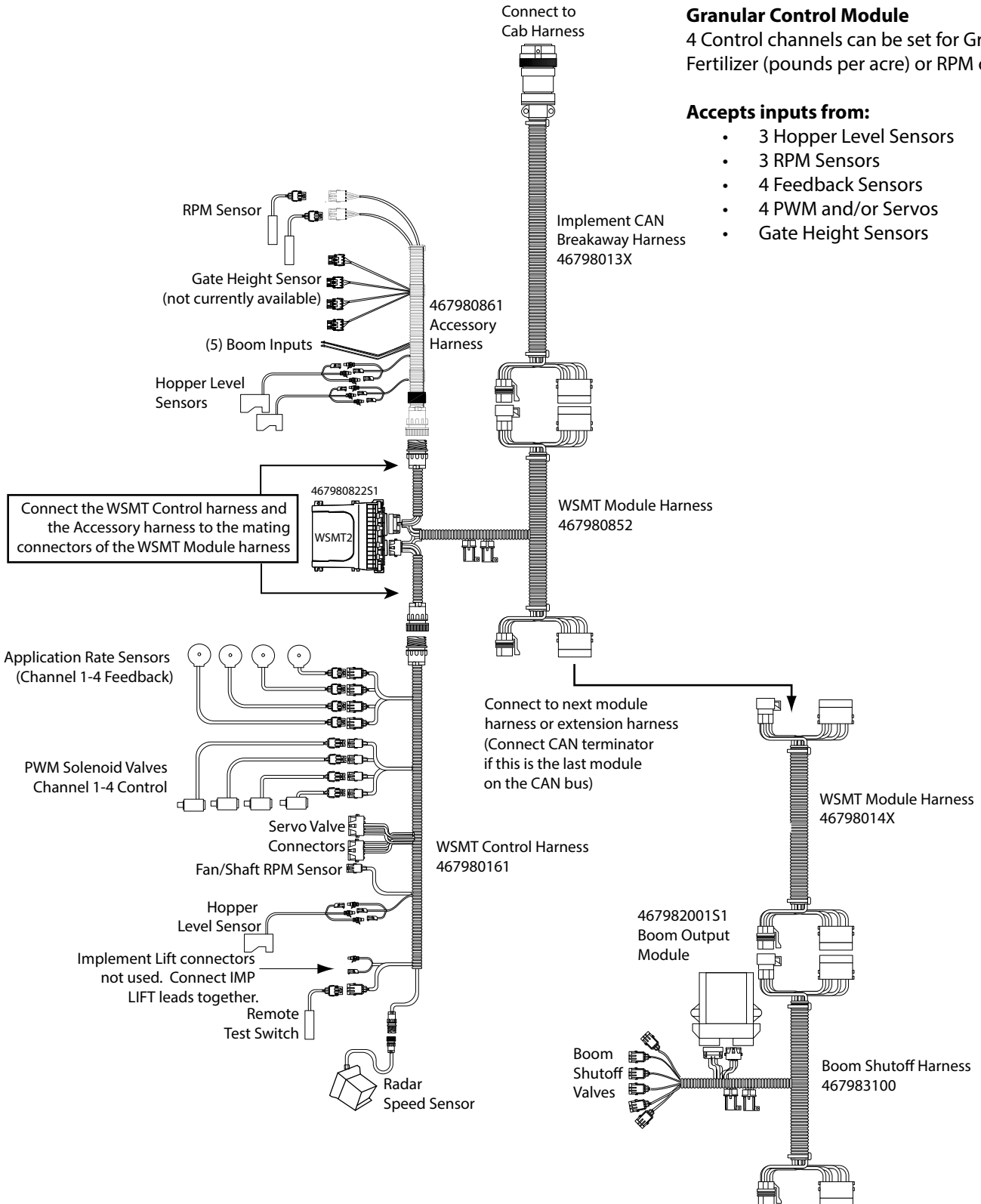

IntelliAg® WSMT2

-0161 Control Harness

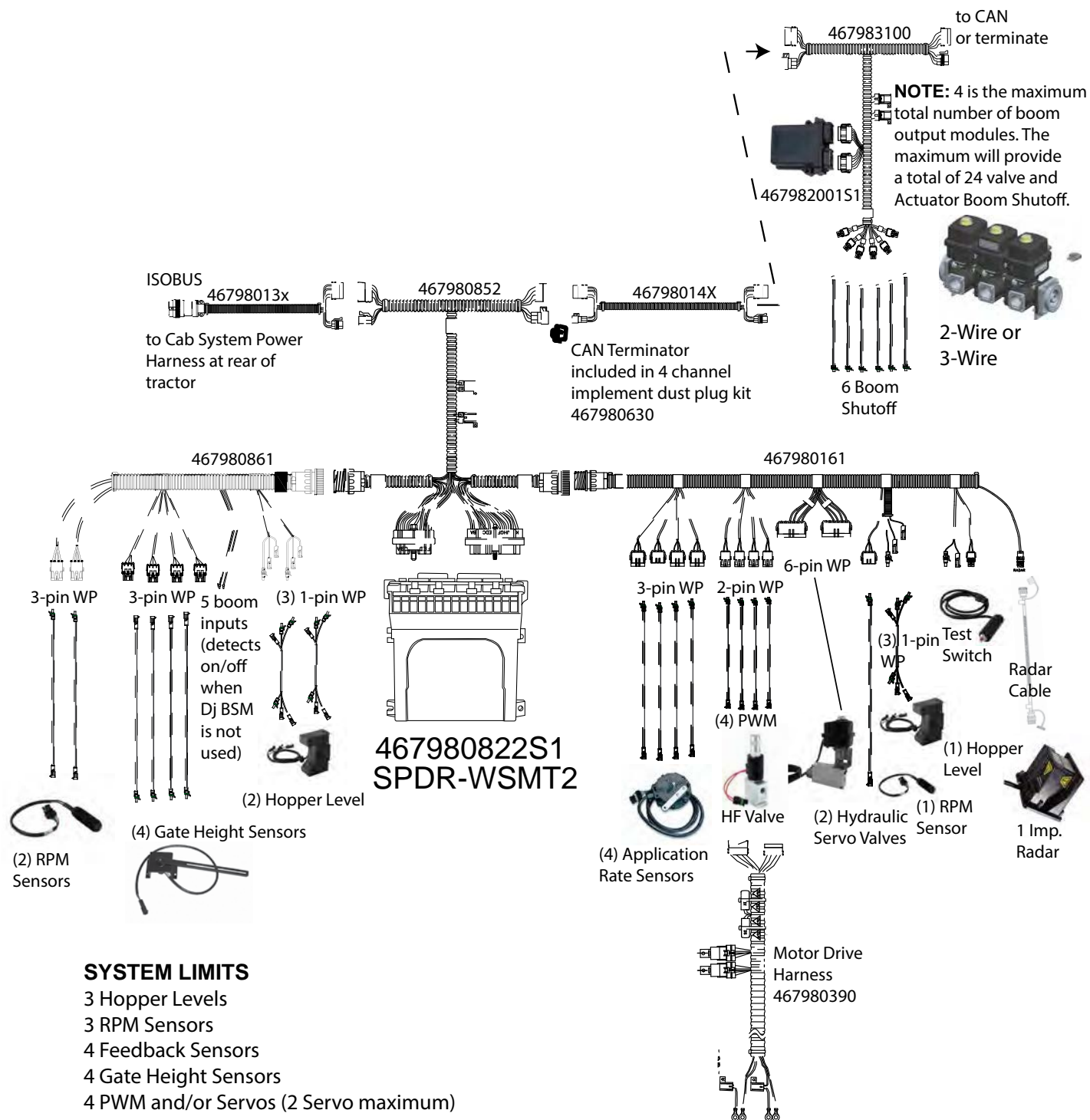

SYSTEM LIMITS

- 3 Hopper Levels
- 3 RPM Sensors
- 4 Feedback Sensors
- 4 Gate Height Sensors
- 4 PWM and/or Servos (2 Servo maximum)

IntelliAg® WSMT2

System Parts List

HITCH EXTENSIONS

Part Number	Description
467980134	Hitch Extension 6'
467980132	Hitch Extension 10'
467980136	Hitch Extension 15'
467980131	Hitch Extension 20'
467980133	Hitch Extension 30'
467980130	Hitch Extension 40'
467980135	Hitch Extension 50'
467980142	CAN Extension 5'
467980141	CAN Extension 10'
467980140	CAN Extension 20'
467980143	CAN Extension 25'
467980144	CAN Extension 40'
467980146	CAN Extension 45'
467980822S1	WSMT2 SPDR Spreader Module
467980852	WSMT Harness
467980630	4 Ch. Imp. Dust Plug Kit w/CAN Term.
110110099	Ty Wrap Bundle 100 14"
467980161	Control Harness
467980861	Accessory Input Harness

RADAR

Part Number	Description
467831000S9	Radar III w/ 14' Cable & Mtg Brkt
439400024	Radar Extension Cable 10'
439400065	Radar Extension Cable 15'
439400064	Radar Extension Cable 25'
464210515S1	Test Switch

RPM

Part Number	Description
	Hall Effect Sensor RPM
463500030S1	(Smooth)
466970014S1	(Threaded)
459680922	Extension Cable 3Pin WP 15'

GATE HEIGHT 1-4

Part Number	Description
466492370S1	Gate Height Sensor
457901810	3Pin WP Ext. Cable 15'
457901811	3Pin WP Ext. Cable 30'
457901812	3Pin WP Ext. Cable 45'

HOPPER LEVEL 1-3

Part Number	Description
466820720S3	Hopper Level Sensor
466820713	3-1Pin WP Ext. Cable 5'
466820712S1	3-1Pin WP Ext. Cable 10'
466820714	3-1Pin WP Ext. Cable 15'
466820710S3	3-1Pin WP Ext. Cable 20'

PULSE-WIDTH MODULATION

Part Number	Description
467092004S1	Hydraulic Valve HydraForce 4 GPM
467092008S1	Hydraulic Valve HydraForce 8 GPM
467092050S1	Hydraulic Valve HydraForce 25 GPM
467980470	12 Ga. 2Pin WP Ext. Cable 15'
467980471	12 Ga. 2Pin WP Ext. Cable 20'
467980473	12 Ga. 2Pin WP Ext. Cable 30'
467980472	12 Ga. 2Pin WP Ext. Cable 40'

SERVO VALVES (HYDRAULIC)

Part Number	Description
155570006	Hydraulic Valve and Actuator 5 GPM 20' cable
155570003	Hydraulic Valve and Actuator 9 GPM 20' cable
155570018	Hydraulic Valve and Actuator 10 GPM 11' cable
155570021	Hydraulic Valve and Actuator 11 GPM 20' cable
155570011	Hydraulic Valve and Actuator 13 GPM 20' cable
155570013	Hydraulic Valve and Actuator 16 GPM 20' cable
155570004	Hydraulic Valve and Actuator 18 GPM 20' cable
155570016	Hydraulic Valve and Actuator 20 GPM 20' cable
155570002	Hydraulic Valve and Actuator 23 GPM 10' cable
155570015	Hydraulic Valve and Actuator 25 GPM 20' cable
155570009	Hydraulic Valve and Actuator 28 GPM 20' cable
155570007	Hydraulic Valve and Actuator 30 GPM 10' cable
155570001	Hydraulic Valve and Actuator 30 GPM 20' cable
155570017	Hydraulic Valve and Actuator 30 GPM 30' cable
155570022	Hydraulic Valve and Actuator 58 GPM 20' cable
REQUIRED DRIVERS	
439400026	Valve Driver Extension 10'

FEEDBACK SENSORS 1-4

Part Number	Description
464360178S1	AR Sensor 360 1' Cable
464360176S1	AR Sensor 360 5' Cable
464360179S1	AR Sensor 360 6' Cable
464360170S1	AR Sensor 360 10' Cable
464360171S1	AR Sensor 360 15' Cable
464360177S1	AR Sensor 360 22' Cable
464360172S1	AR Sensor 360 30' Cable
457141810	App. Rate 1" Coupler
457141850	App. Rate 1.25" Coupler
457901810	3Pin WP Ext. Cable 15'
457901811	3Pin WP Ext. Cable 30'
457901812	3Pin WP Ext. Cable 45'

ELECTRIC MOTOR DRIVER

Part Number	Description
467980490	High Current Electric Motor Harness
467980390	Power Harness (High current > than 10 A)

IntelliAg® WSMT2

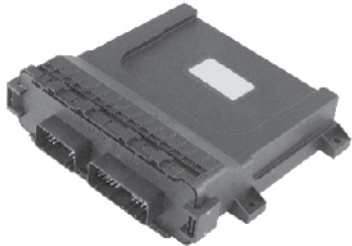

**WSMT2
Module**

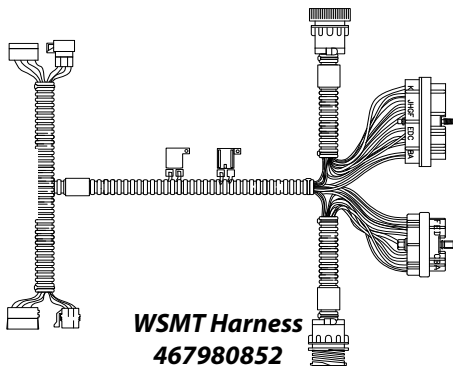

**WSMT Harness
467980852**

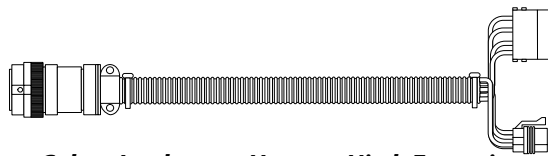

**Cab to Implement Harness Hitch Extension
46798013X**

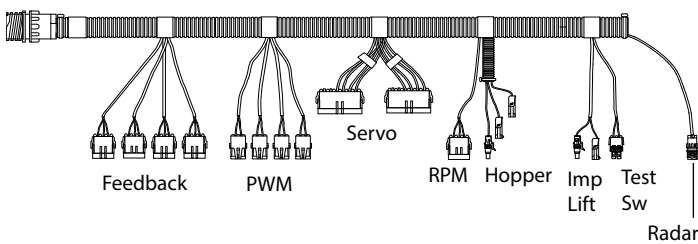

**4 Channel Harness with Accessory Inputs
467980161**

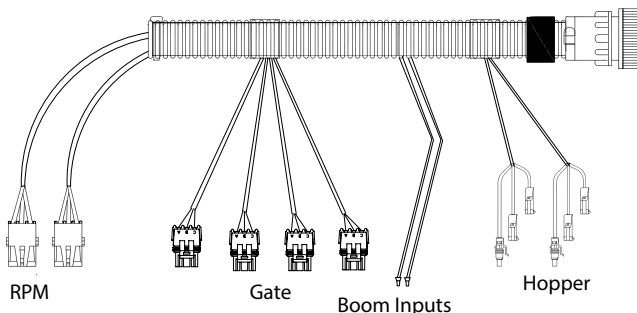

**Granular Spreader Accessory Input Harness
467980861**

Working Set Master Module (WSMT2)

The Working Set Master Module (WSMT2) houses the system's primary interface device. All system parameters, constants, and memory are stored in the WSMT and controls the application of material by interfacing with proportional hydraulic valves and feedback sensors. Several WSMT modules are available for a variety of applications.

Working Set Master Module	
Part Number	Description
46798-082251	Module, SPDR-WSMT2 (Spreader Control)
46798-0630	4 Channel Implement Dust Plug Kit with Terminators
11011-0099	Ty Wrap Bundle 100 14 in.

Working Set Master Harness

WSMT Harnessing	
Part Number	Description
46798-0852	WSMT Harness 37-pin CPC with APER (Material Application)

NOTE: SE style harnesses have 1 gray and 1 black 12-pin Deutsch DT connector.

Cab to Implement Harness Hitch Extension

Tractor Cab to Implement Harness Hitch Extensions	
Part Number	Description
46798-0134	6 ft. Hitch Extension ISO system CAN
46798-0132	10 ft. Hitch Extension ISO system CAN
46798-0136	15 ft. Hitch Extension ISO system CAN
46798-0131	20 ft. Hitch Extension ISO system CAN
46798-0133	30 ft. Hitch Extension ISO system CAN
46798-0130	40 ft. Hitch Extension ISO system CAN
46798-0135	50 ft. Hitch Extension ISO system CAN
46798-0457	40 ft. Hitch to Hitch Extension

WSMT2 Harnesses (Control Channel/Accessory Inputs)

37-pin CPC Control Harnesses	
Part Number	Description
46798-0161	WSMT Material Application 4 Ch Actuator Harness with APER (application error rate)
46798-0861	Granular Spreader Accessory Harness (2 RPM, 4 Gate Height, 5 Boom Inputs, 2 Hopper Level)

IntelliAg® WSMT2

CAN to Hitch Connector Harnesses

Harness accommodates disconnection between implement and tow-behind aircart to second hitch extension.



Rear Implement Hitch Harness (Deutsch)
467980360



Rear Implement Hitch Harness (IBBC) 6 ft
467980361



Rear Implement Hitch Harness (IBBC) 20 ft
467980362

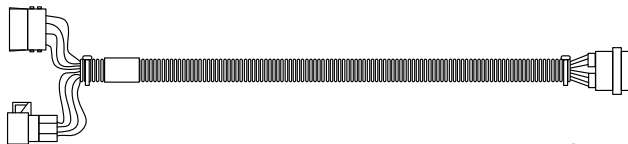

Rear Implement Hitch Harness (IBBC) 25 ft
467980363

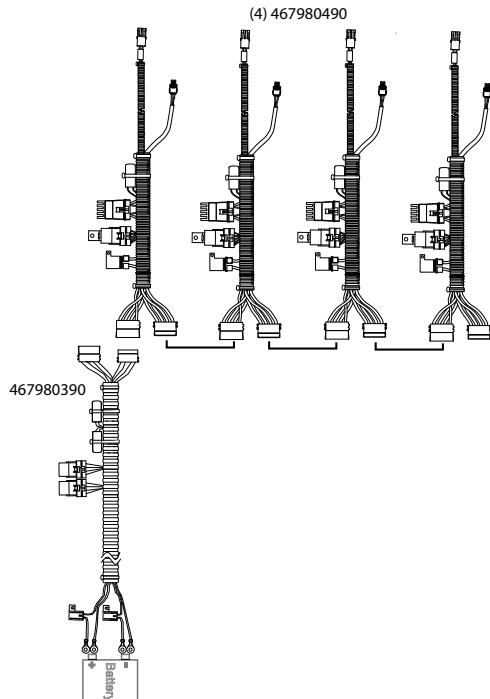

CAN Y Cable and Electric Motor Driver
467980390 and 467980490

Rear Implement Hitch Harness	
Part Number	Description
46798-0360	Rear Implement Hitch Harness with Deutsch 9-pin (CAN to Hitch) 3 ft.
46798-0361	Rear Implement Hitch Harness with IBBC 9-pin (CAN to Hitch) 6 ft.
46798-0362	Rear Implement Hitch Harness with IBBC 9-pin 20 ft.
46798-0363	Rear Implement Hitch Harness with IBBC 9-pin 25 ft.

Adapter Harnesses

Adapter Harness	
Part Number	Description
46798-0390	CAN Y Cable (DICKEY-john®, Case) (used with 46798-0490)
46798-0490	Electric Motor Driver (solenoid relay cable for high current electric motor drive)

Implement Kit

IAGRANULARIMPKIT Granular Implement Kit consists of the following	
Part Number	Description
46798-0136	15' Hitch Harness
46798-0852	WSMT2 Harness
46798-082251	WSMT2 SPDR Spreader Module
11001-1474	Operator's Manual

IntelliAg® WSMT2

WSMB Output Module Driver



Output Shutoff Module

A WSMB Output Module Driver communicates with the Boom Switch Module for section on/off control.

Row Shutoff Parts	
Part Number	Description
46798-2001S1	Output Shutoff Module
46798-3100	Boom Shutoff Harness (6 Boom/3-Wire Shutoff)
46798-3101	Boom Shutoff Harness (6 Boom/2-Wire Shutoff) (used with non-DICKEY-john® Valves and 464820510)
46798-2100	Row Shutoff (RSO) Harness (12 solenoid)
46482-0510S1	Solenoid Driver (plugs into 46798-3501 and -3101 for current >2 Amp)

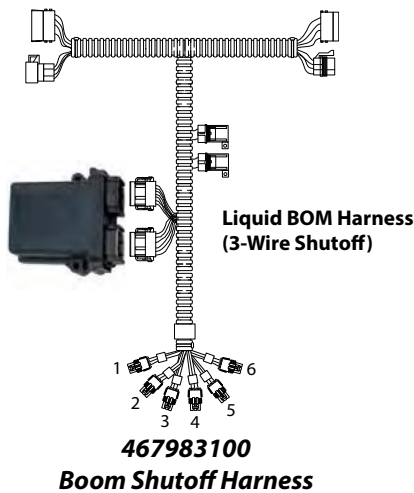

**467983100
Boom Shutoff Harness**

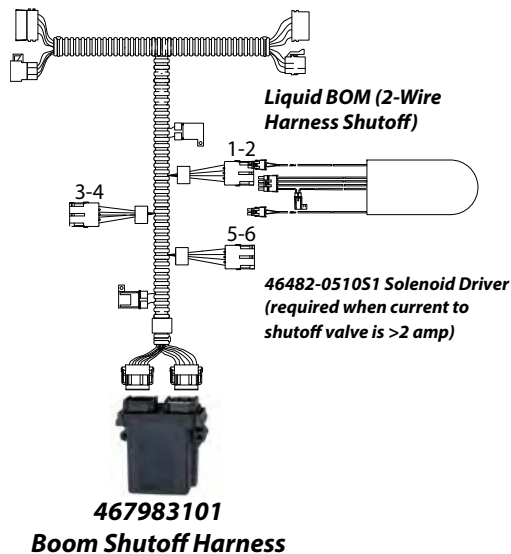

**467983101
Boom Shutoff Harness**

IntelliAg® WSMT2

Boom Switch Module



Boom Switch Module



Extended Shut Off Module

Boom Switch Module controls up to 24 boom on/off shutoff valves.

Switch modules placed in the cab allow each row/section to be controlled or use the master switch for all row/section on or off.

Boom Switch Module Parts	
Part Number	Description
46798-4030S1	Boom Switch Module (BSM) (1-6 sections)
46798-4040S1	Extended Shut Off Module (ESM) (7-24 row)
46798-4150	BSM/ESM Mounting Bracket (4 total) for use with 5" Virtual Terminal (AI-50)
46798-4160	BSM/ESM U-Mount Bracket (accommodates mounting 46798-4030S1)
46798-0330	BSM Harness to Tractor Harness
46798-0335	CFM to JD GS2 Cab Harness
46798-0340	BSM Harness 60 in. CAN Extension
46798-4180S1	ESM Foot Switch Cable (Liquid)
46798-0625	BSM/ESM Mounting Bracket for use with 10" Virtual Terminal (AI-100)
46798-0626	BSM/ESM Mounting Bracket for use with 12" Virtual Terminal (Topcon X35)

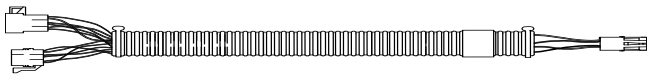

BSM Harness 24"
467980330



BSM CAN Harness Extension 60"
467980340

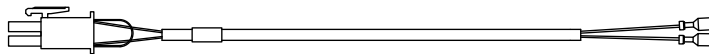

ESM Foot Switch Cable 96"
467984180



Case Tractor Cab Harness 24"
467980330

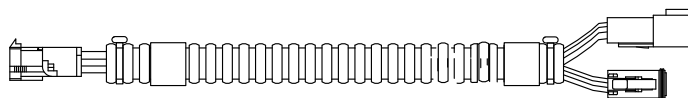

CFM to JD GS2 Cab Harness
467980335

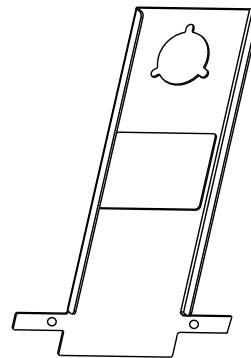

BSM/ESM Mounting Bracket (Topcon X35) 467980626

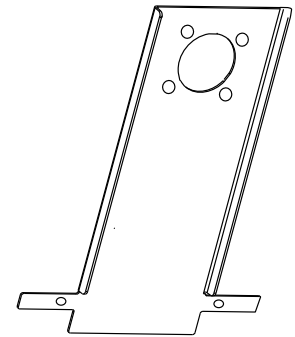

BSM/ESM Mounting Bracket (AI-100) 467980625

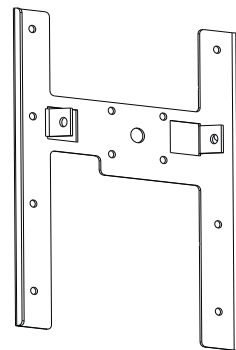

BSM/ESM Mounting Bracket 467984150

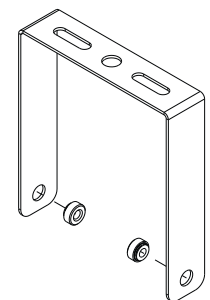

BSM U Mount Bracket 467984160

IntelliAg® WSMT2

Radar Y Harnesses

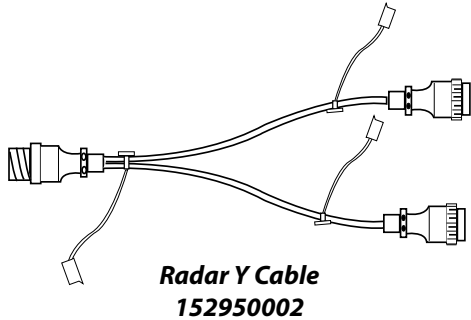

Adapter Harness	
Part Number	Description
15295-0002	Radar Y Cable for Case Magnum 7110-8950 Series
45640-4670	Radar Y Cable for Case Maxum 5110-5240, MX90-170 Series, Steiger 9110-9390, 9210-9390 Series, Case STX 275-450 Series
45640-3030	Radar Y Cable for Caterpillar 65A, 65B, 75B Series
45640-4360S1	Radar Y Cable for 35, 45, 55, C, D, E Series
45640-2520S3	Radar Y Cable for John Deere 4xxx, 7xxx, 80xx Series
45640-2530S3	Radar Y Cable for John Deere 7600-8010T
45640-4810	Radar Y Cable for John Deere 8300 and 9400 Series

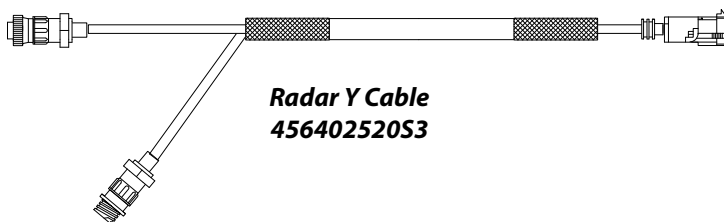
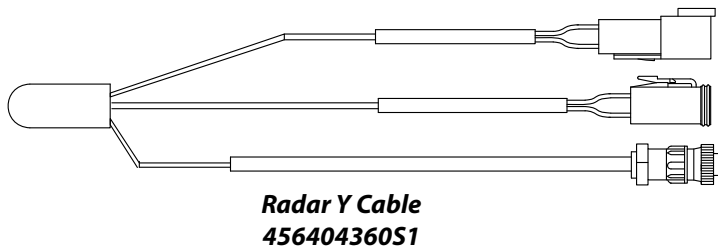
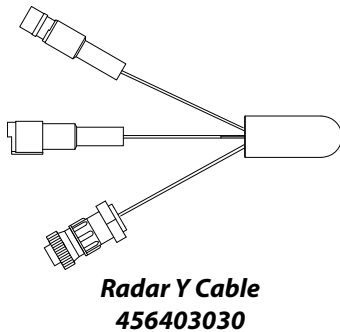
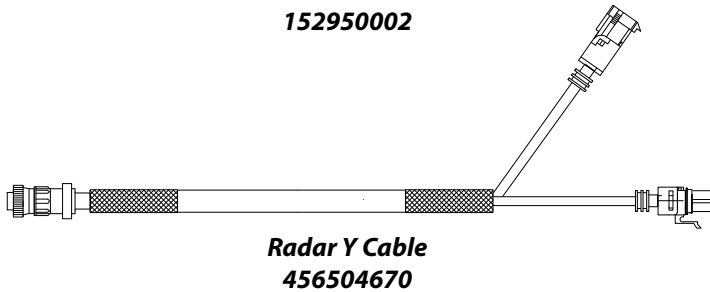

IntelliAg® WSMT2

Base System - Sprayer

- IntelliAg® Virtual Terminal Topcon X35
- Tractor harness for use with Virtual Terminal
- System power harness with ISO hitch connector
- ISO master switch to control on/off
- Hitch extension harness
- LIQIV - WSMT2
- WSMT2 T harness
- Control harness for connection to valves and feedback sensors

Monitor and Control

Boom Output Module



Controls boom shutoff section valves.

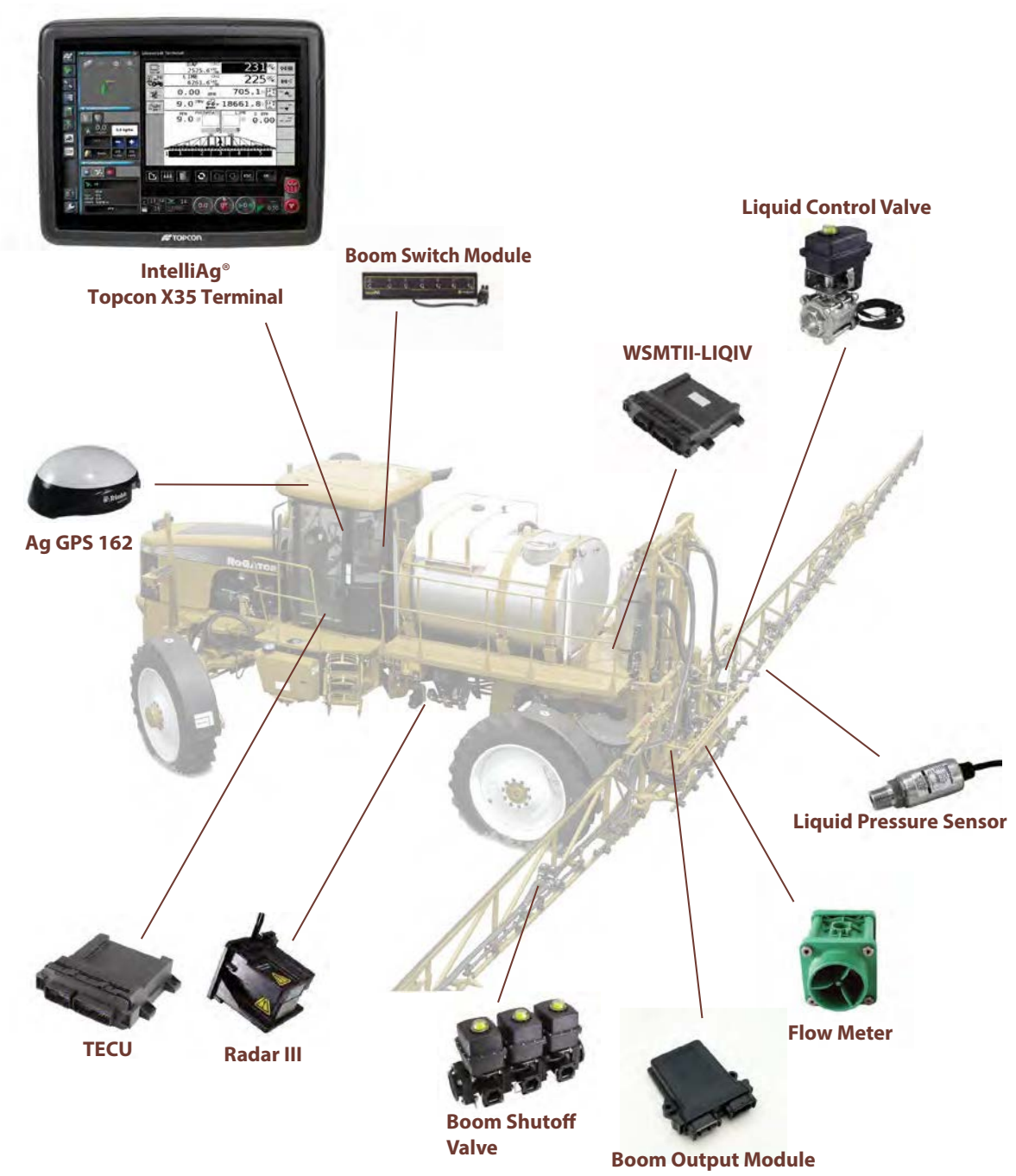

IntelliAg® WSMT2

Sprayer Control System Diagram

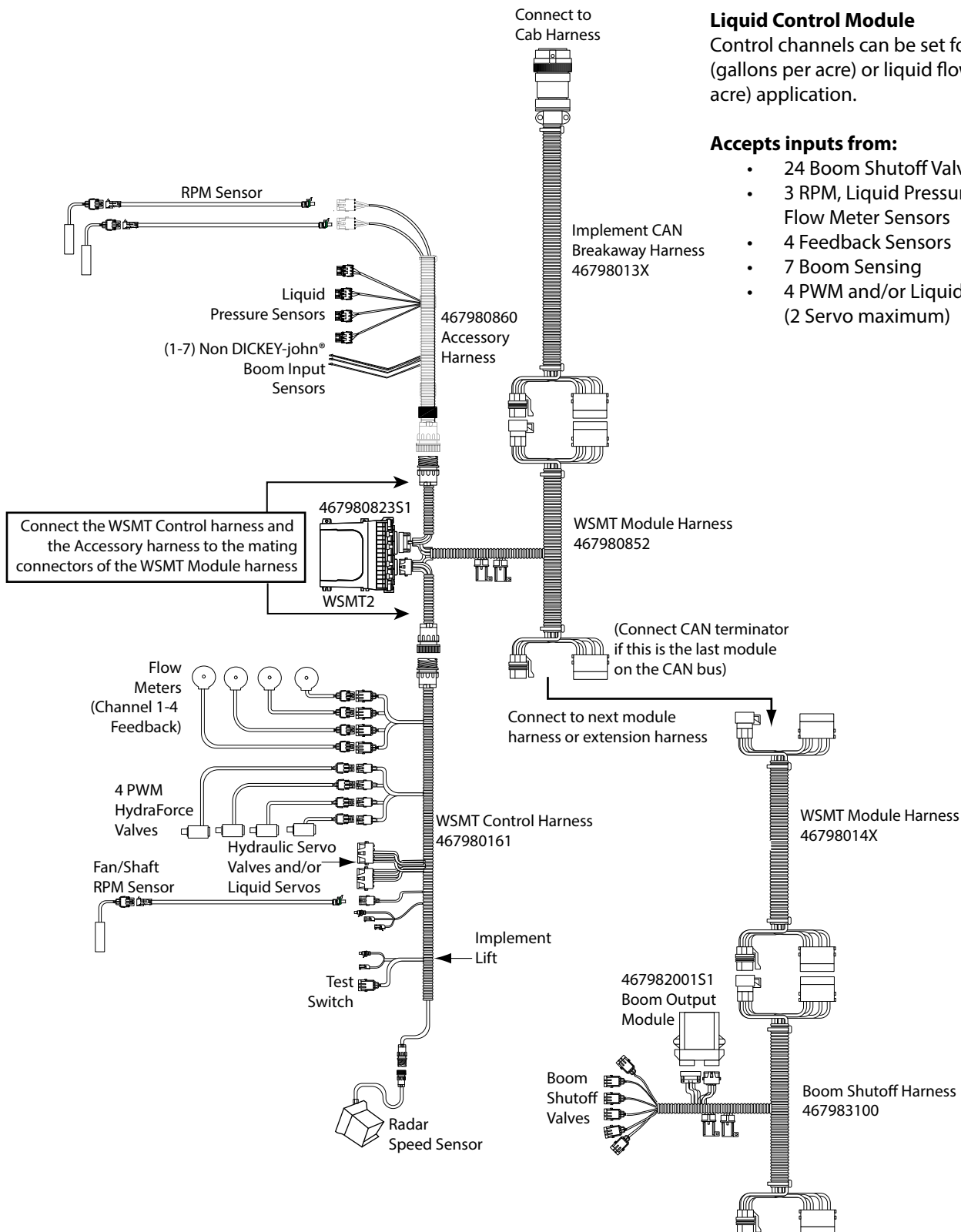

Liquid Control Module

Control channels can be set for liquid pressure (gallons per acre) or liquid flow (gallons per acre) application.

Accepts inputs from:

- 24 Boom Shutoff Valves
- 3 RPM, Liquid Pressure, and/or Flow Meter Sensors
- 4 Feedback Sensors
- 7 Boom Sensing
- 4 PWM and/or Liquid Servos (2 Servo maximum)

Connect the WSMT Control harness and the Accessory harness to the mating connectors of the WSMT Module harness

(Connect CAN terminator if this is the last module on the CAN bus)

Connect to next module harness or extension harness

Implement Lift

IntelliAg® WSMT2

-0161 Control Harness

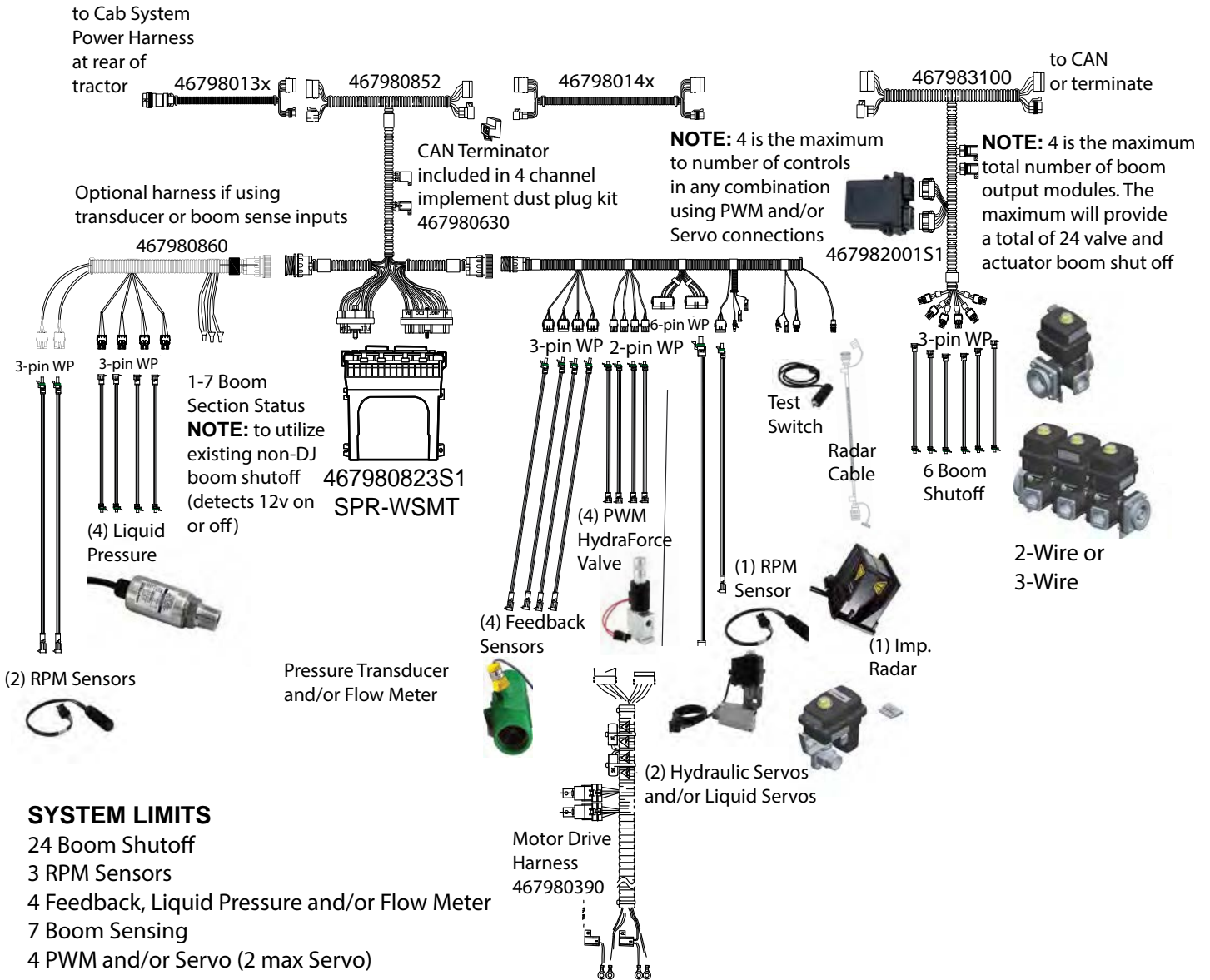

*Refer to page 63 for details on Electric Pump/Motor Driver harness

IntelliAg® WSMT2

System Parts List

HITCH EXTENSIONS

Part Number	Description
467980134	Hitch Extension 6'
467980132	Hitch Extension 10'
467980136	Hitch Extension 15'
467980131	Hitch Extension 20'
467980133	Hitch Extension 30'
467980130	Hitch Extension 40'
467980135	Hitch Extension 50'
467980142	CAN Extension 5'
467980141	CAN Extension 10'
467980140	CAN Extension 20'
467980143	CAN Extension 25'
467980144	CAN Extension 40'
467980146	CAN Extension 45'
467980823S1	WSMT4 Sprayer Module
467980852	WSMT Harness
467980161	Control Harness
467980860	Liquid Accessory Input Harness
467980630	4 Ch. Imp. Dust Plug Kit w/CAN Term.
110110099	Ty Wrap Bundle 100 14"

RADAR

Part Number	Description
467831000S9	Radar III w/ 14' Cable & Mtg Brkt
439400024	Radar Extension 10'
439400065	Radar Extension 15'
439400064	Radar Extension 25'
464210515S1	Test Switch

RPM

Part Number	Description
	Hall Effect Sensor RPM
463500030S1	(Smooth)
466970014S1	(Threaded)
459680922	HES Ext. Cable 3Pin WP 15'

PULSE-WIDTH MODULATION

Part Number	Description
467092004S1	Hydraulic Valve HydraForce 4 GPM
467092008S1	Hydraulic Valve HydraForce 8 GPM
467092050S1	Hydraulic Valve HydraForce 25 GPM
467980470	12 Ga. 2Pin WP Ext. Cable 15'
467980471	12 Ga. 2Pin WP Ext. Cable 20'

SERVO VALVES (HYDRAULIC)

Part Number	Description
155570006	Hydraulic Valve and Actuator 5 GPM 20' cable
155570003	Hydraulic Valve and Actuator 9 GPM 20' cable
155570018	Hydraulic Valve and Actuator 10 GPM 11' cable
155570021	Hydraulic Valve and Actuator 11 GPM 20' cable
155570011	Hydraulic Valve and Actuator 13 GPM 20' cable
155570013	Hydraulic Valve and Actuator 16 GPM 20' cable
155570004	Hydraulic Valve and Actuator 18 GPM 20' cable
155570016	Hydraulic Valve and Actuator 20 GPM 20' cable
155570002	Hydraulic Valve and Actuator 23 GPM 10' cable
155570015	Hydraulic Valve and Actuator 25 GPM 20' cable
155570009	Hydraulic Valve and Actuator 28 GPM 20' cable
155570007	Hydraulic Valve and Actuator 30 GPM 10' cable
155570001	Hydraulic Valve and Actuator 30 GPM 20' cable
155570017	Hydraulic Valve and Actuator 30 GPM 30' cable
155570022	Hydraulic Valve and Actuator 58 GPM 20' cable

REQUIRED DRIVER

439400026	Valve Driver Extension 10'
-----------	----------------------------

LIQUID PRESSURE TRANSDUCER

Part Number	Description
465700010	0-100 psi
457901810	3Pin WP Ext. Cable 15'
457901811	3Pin WP Ext. Cable 30'
457901812	3Pin WP Ext. Cable 45'

FLOW METERS

Part Number	Description
466491170S1	Flow Meter 1/2"
PM00370023S1	Flow Meter 3/4"
PM00370030S1	Flow Meter 1"
PM00370040S1	Flow Meter 1.5"
PM00370048S1	Flow Meter 2"
PM00370068S1	Flow Meter 3"
PM00370088S1	Flow Meter 4"
PMNPT70116S1	SS Flow Meter 1/2"
PMNPT70121S1	SS Flow Meter 3/4"
PMNPT70126S1	SS Flow Meter 1"
PMNPT70136S1	SS Flow Meter 1-1/2"
PMNPT70146S1	SS Flow Meter 2"
457901810	3Pin WP Ext. Cable 15'
457901811	3Pin WP Ext. Cable 30'
457901812	3Pin WP Ext. Cable 45'

WORKING SET MEMBER

Part Number	Description
467982000S1	BOM (Boom Output Module)
467983100	BOM Harness

LIQUID VALVE AND ACTUATOR (LIQUID FLOW CONTROL)

Part Number	Description
467095010	Valve & Actuator Assy. 3/8" 2-Way Stainless Steel
467095220	Valve & Actuator Assy. 3/8" 3-Way Stainless Steel
467095020	Valve & Actuator Assy. 1/2" 2-Way Stainless Steel
467095030	Valve & Actuator Assy. 3/4" 2-Way Poly
467095280	Valve & Actuator Assy. 1" 2-Way Poly
467095290	Valve & Actuator Assy. 1" 2-Way Stainless Steel
467095050	Valve & Actuator Assy. 1-1/2" 3-Way Poly
467095140	Valve & Actuator Assy. 1-1/2" 3-Way Stainless Steel
467095150	Valve & Actuator Assy. 2" 2-Way Stainless Steel
467095160	Valve & Actuator Assy. 2" 3-Way Stainless Steel
467095170	Valve & Actuator Assy. 3" 2-Way Stainless Steel
457901820	6Pin WP Extension Cable 15'
457901821	6Pin WP Extension Cable 30'

BOOM "BANK" SHUT OFF VALVES

Part Number	Description
467096000	Valve & Actuator 3/4"
467096010	Valve & Actuator 3/4" 3 Bank
467096020	Valve & Actuator 3/4" 5 Bank
467095130	Valve & Actuator 1" Single
457901810	3Pin WP Ext. Cable 15'
457901811	3Pin WP Ext. Cable 30'
457901812	3Pin WP Ext. Cable 45'

ELECTRIC MOTOR DRIVER

Part Number	Description
467980490	High Current Electric Motor Harness
467980390	Power Harness (High current > than 10 A)

RAVEN FAST VALVE ADAPTER HARNESS

Part Number	Description
466980100	Raven Fast Valve Adapter Harness

IntelliAg® WSMT2

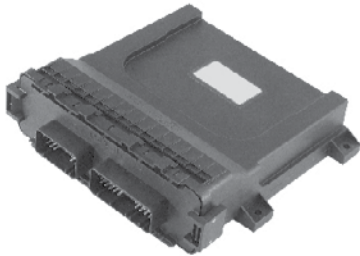

**WSMT2
Module**

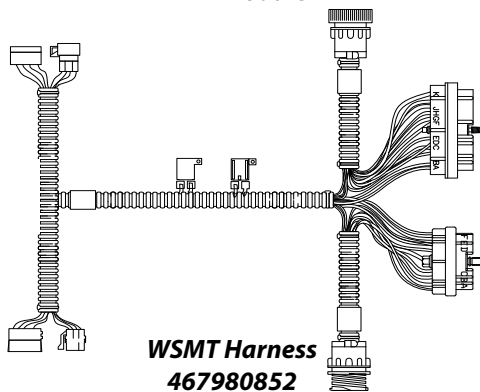

**WSMT Harness
467980852**

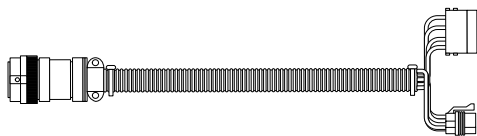

**Cab to Implement Harness Hitch Extension
46798013X**

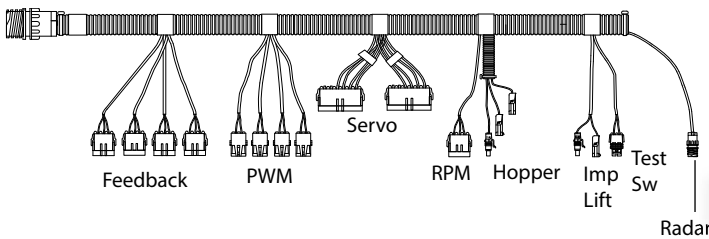

**Material Application Accessory Harness
467980161**

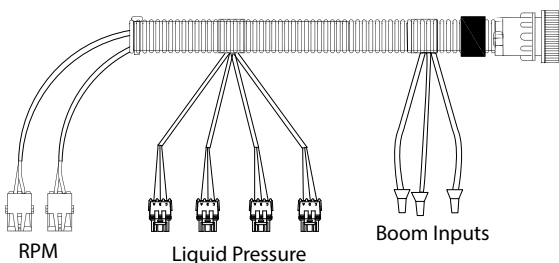

**Sprayer Accessory Harness
467980860**

Working Set Master Module (WSMT2)

The Working Set Master Module (WSMT2) houses the system's primary interface device. All system parameters, constants, and memory are stored in the WSMT and controls the application of material by interfacing with proportional hydraulic valves and feedback sensors. Several WSMT modules are available for a variety of applications.

Working Set Master Module	
Part Number	Description
46798-082351	Module, SPR-WSMT2 (Sprayer Control)
46798-0630	4 Channel Implement Dust Plug Kit with Terminators
11011-0099	Ty Wrap Bundle 100 14 in.

Working Set Master Harness

WSMT Harnessing	
Part Number	Description
46798-0852	WSMT Harness with APER (Material Application)

NOTE: SE style harnesses have 1 gray and 1 black 12-pin Deutsch DT connector.

Cab to Implement Harness Hitch Extension

Tractor Cab to Implement Harness Hitch Extensions	
Part Number	Description
46798-0134	6 ft. Hitch Extension ISO system CAN
46798-0132	10 ft. Hitch Extension ISO system CAN
46798-0136	15 ft. Hitch Extension ISO system CAN
46798-0131	20 ft. Hitch Extension ISO system CAN
46798-0133	30 ft. Hitch Extension ISO system CAN
46798-0130	40 ft. Hitch Extension ISO system CAN
46798-0135	50 ft. Hitch Extension
46798-0457	40 ft. Hitch to Hitch Extension

WSMT2 Harnesses (Control Channels/Accessory Inputs)

37-pin CPC Style Control Harnesses	
Part Number	Description
46798-0161	WSMT Material Application 4 Ch Actuator Harness with APER (application error rate)
46798-0860	Liquid Sprayer Accessory Harness (2 RPM, 4 Liquid, 7 Boom Inputs)

IntelliAg® WSMT2

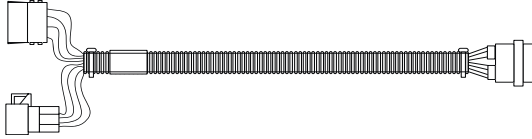

Rear Implement Hitch Harness (Deutsch) 3 ft
467980360

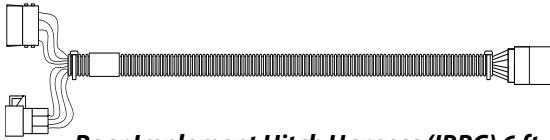

Rear Implement Hitch Harness (IBBC) 6 ft
467980361

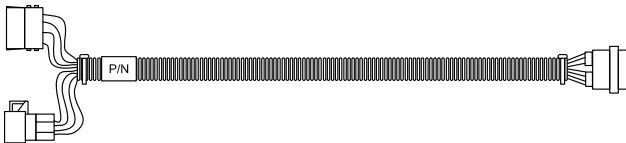

Rear Implement Hitch Harness (IBBC) 20 ft
467980362



Rear Implement Hitch Harness (IBBC) 25 ft
467980363

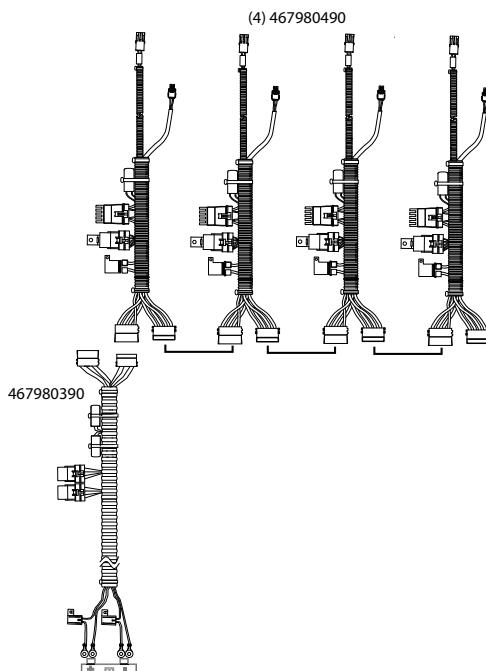

CAN Y Cable and Electric Motor Driver
467980390 and 467980490

CAN to Hitch Connector Harnesses

Harness accommodates disconnection between implement and tow-behind aircart to second hitch extension.

Rear Implement Hitch Harness	
Part Number	Description
46798-0360	Rear Implement Hitch Harness with Deutsch 9-pin (CAN to Hitch) 3 ft.
46798-0361	Rear Implement Hitch Harness with IBBC 9-pin (CAN to Hitch) 6 ft.
46798-0362	Rear Implement Hitch Harness with IBBC 9-pin 20 ft.
46798-0363	Rear Implement Hitch Harness with IBBC 9-pin 25 ft.

Adapter Harnesses

Adapter Harness	
Part Number	Description
46798-0490	Electric Motor Driver (solenoid relay cable for high current electric motor drive)
46798-0390	CAN Y Cable (used with 46798-0490)

Raven Fast Valve Adapter Harness

Adapter Harness	
Part Number	Description
46698-0100	Raven Fast Valve Adapter Harness
46698-0040S1	Raven Flow Meter Adapter Cable

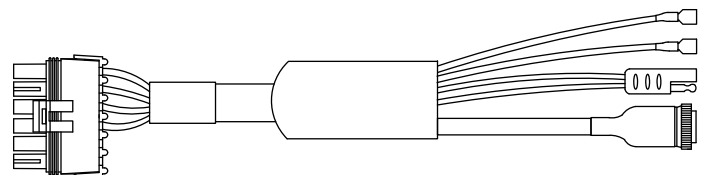

Raven Fast Valve Adapter Harness
466980100

IntelliAg® WSMT2

WSMB Output Module Driver



Output Shutoff Module

A WSMB Output Module communicates with the Boom Switch Module for application on/off control.

Row Shutoff Parts	
Part Number	Description
46798-2001S1	Output Shutoff Module
46798-3100	Liquid Boom Shutoff Harness (6 Boom/3-Wire Shutoff)
46798-3101	Liquid Boom Shutoff Harness (6 Boom/2-Wire Shutoff) (used with non-DICKEY-john® Valves and 464820510)
46798-2100	Row Shutoff (RSO) Harness (12 solenoid)
46482-0510S1	Solenoid Driver (plugs into 46798-3501 and -3101 for current >2 Amp)

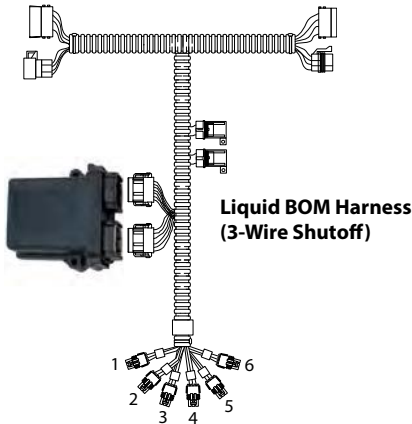

**Liquid Boom Shutoff Harness
467983100**

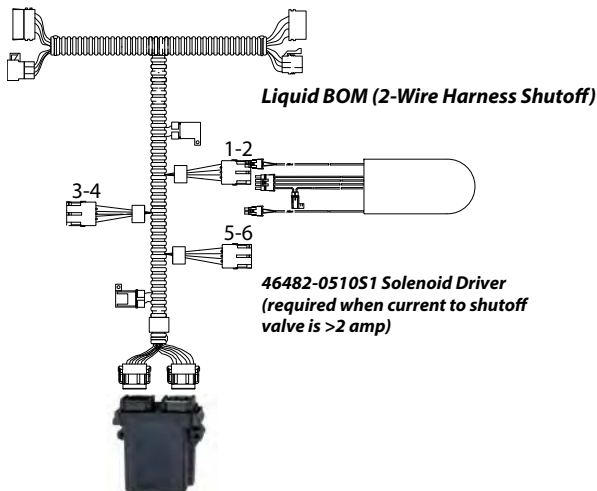

**Liquid Boom Shutoff Harness
467983101**

IntelliAg® WSMT2

Boom Switch Module



Boom Switch Module



Extended Shutoff Module



BSM Harness 24"
467980330

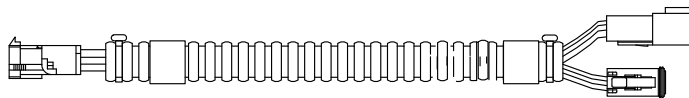

CFM to JD GS2 Cab Harness
467980335



BSM CAN Harness Extension 60"
467980340

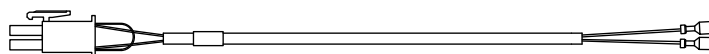

ESM Foot Switch Cable 96"
467984180

Boom Switch Module controls up to 24 boom on/off shutoff valves.

Switch modules placed in the cab allow each row/section to be controlled or use the master switch for all row/section on or off.

Boom Switch Module Parts	
Part Number	Description
46798-4030S1	Boom Switch Module (BSM) (1-6 sections)
46798-4040S1	Extended Shut Off Module (ESM) (7-24 rows)
46798-4150	BSM/ESM Mounting Bracket (4 total) for use with 5" Virtual Terminal (AI-50)
46798-4160	BSM/ESM U-Mount Bracket (accommodates mounting 46798-4030S1)
46798-0330	BSM Harness to Tractor Harness (DICKY-john®, Case)
46798-0335	CFM to JD GS2 Cab Harness
46798-0340	BSM Harness 60 in. CAN Extension
46798-4180S1	BSM Foot Switch Cable (Liquid)
46798-0625	BSM/ESM Mounting Bracket for use with 10" Virtual Terminal (AI-100)
46798-0626	BSM/ESM Mounting Bracket for use with 12" Virtual Terminal (Topcon X35)

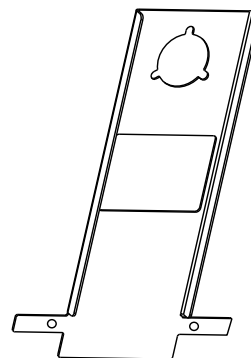

BSM/ESM Mounting Bracket
(Topcon X35) 467980626

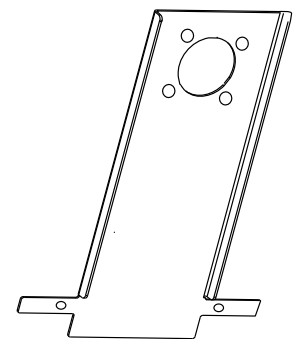

BSM/ESM Mounting Bracket
(AI-100) 467980625

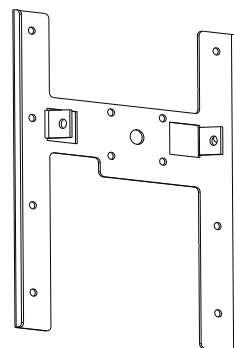

BSM/ESM Mounting Bracket
467984150

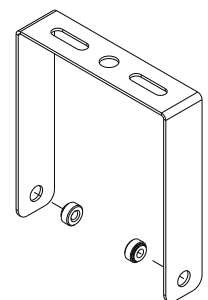

BSM U Mount Bracket
467984160

IntelliAg® WSMT2

Radar Y Harnesses

Adapter Harness	
Part Number	Description
15295-0002	Radar Y Cable for Case Magnum 7110-8950 Series
45640-4670	Radar Y Cable for Case Maxum 5110-5240, MX90-170 Series, Steiger 9110-9390, 9210-9390 Series, Case STX 275-450 Series
45640-3030	Radar Y Cable for Caterpillar 65A, 65B, 75B Series
45640-4360S1	Radar Y Cable for 35, 45, 55, C, D, E Series
45640-2520S3	Radar Y Cable for John Deere 4xxx, 7xxx, 80xx Series
45640-2530S3	Radar Y Cable for John Deere 7600-8010T
45640-4810	Radar Y Cable for John Deere 8300 and 9400 Series

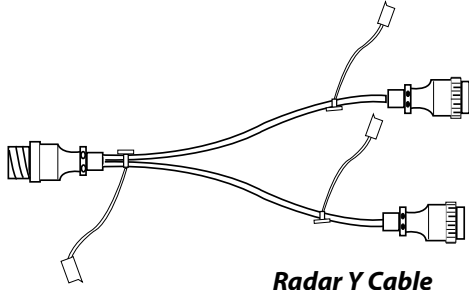

**Radar Y Cable
152950002**

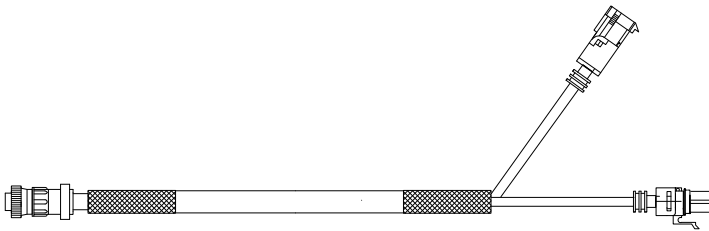

**Radar Y Cable
456504670**



**Radar Y Cable
456402530S3**

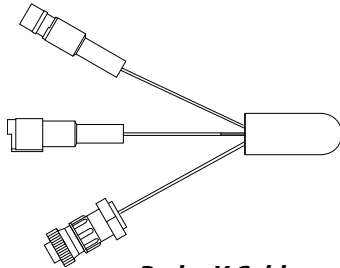

**Radar Y Cable
456403030**

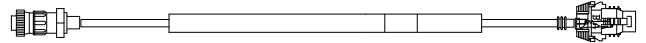

**Radar Y Cable
456504810**

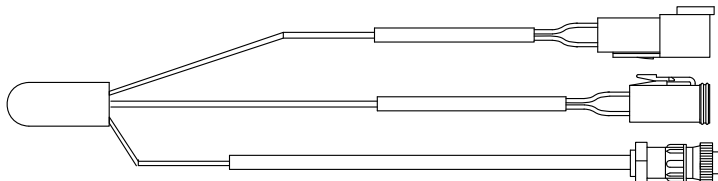

**Radar Y Cable
456404360S1**



**Radar Y Cable
456402520S3**

IntelliAg[®] WSMT2

Monitor and Control

Base System - Anhydrous

- IntelliAg[®] Virtual Terminal Topcon X35
- Tractor harness for use with Virtual Terminal
- System power harness with ISO hitch connector
- ISO master switch to control on/off
- Hitch extension harness
- NH3- WSMT2
- WSMT2 T harness
- Control harness for connection to valves and feedback sensors

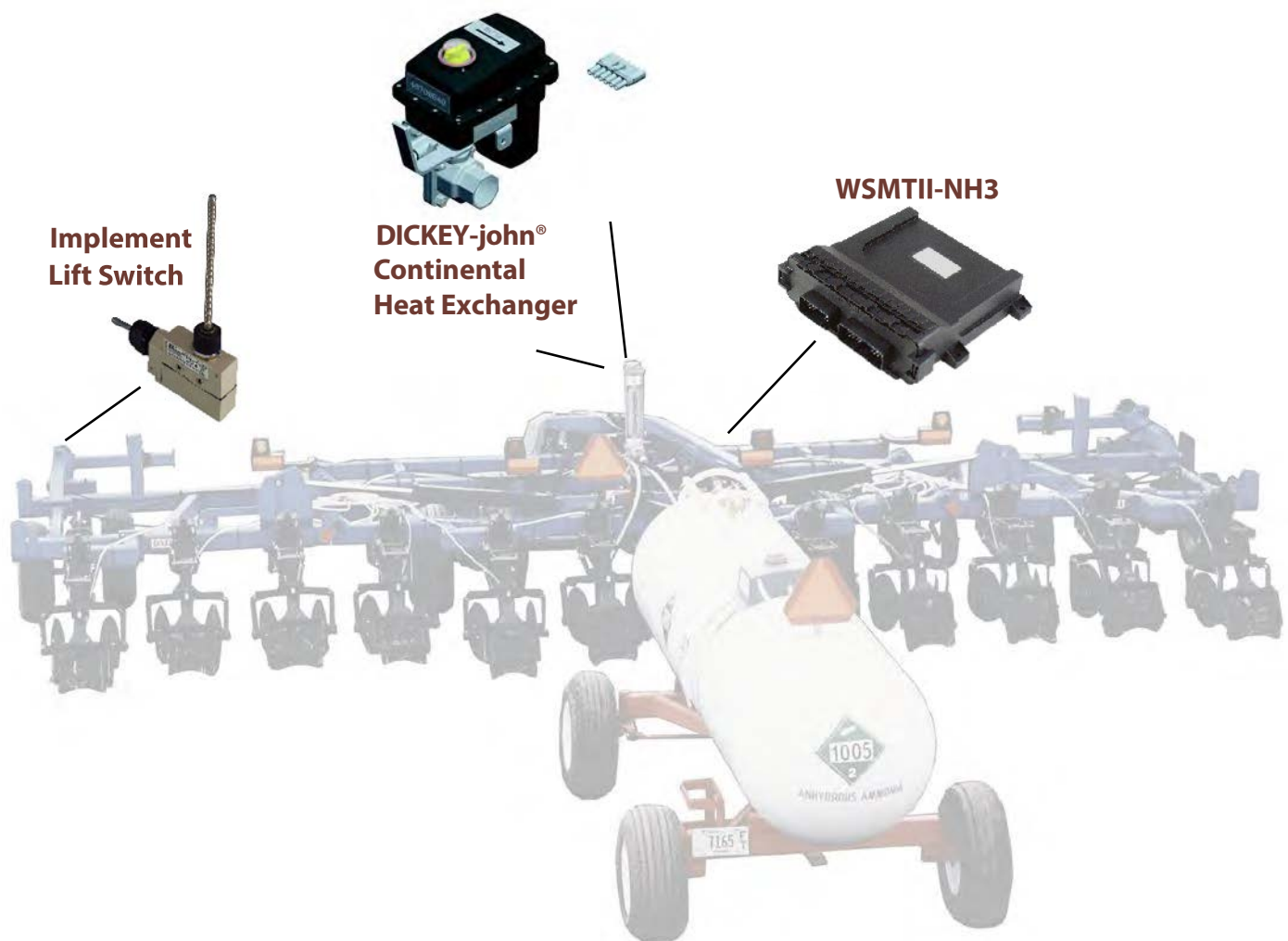

IntelliAg® WSMT2

Anhydrous System Diagram

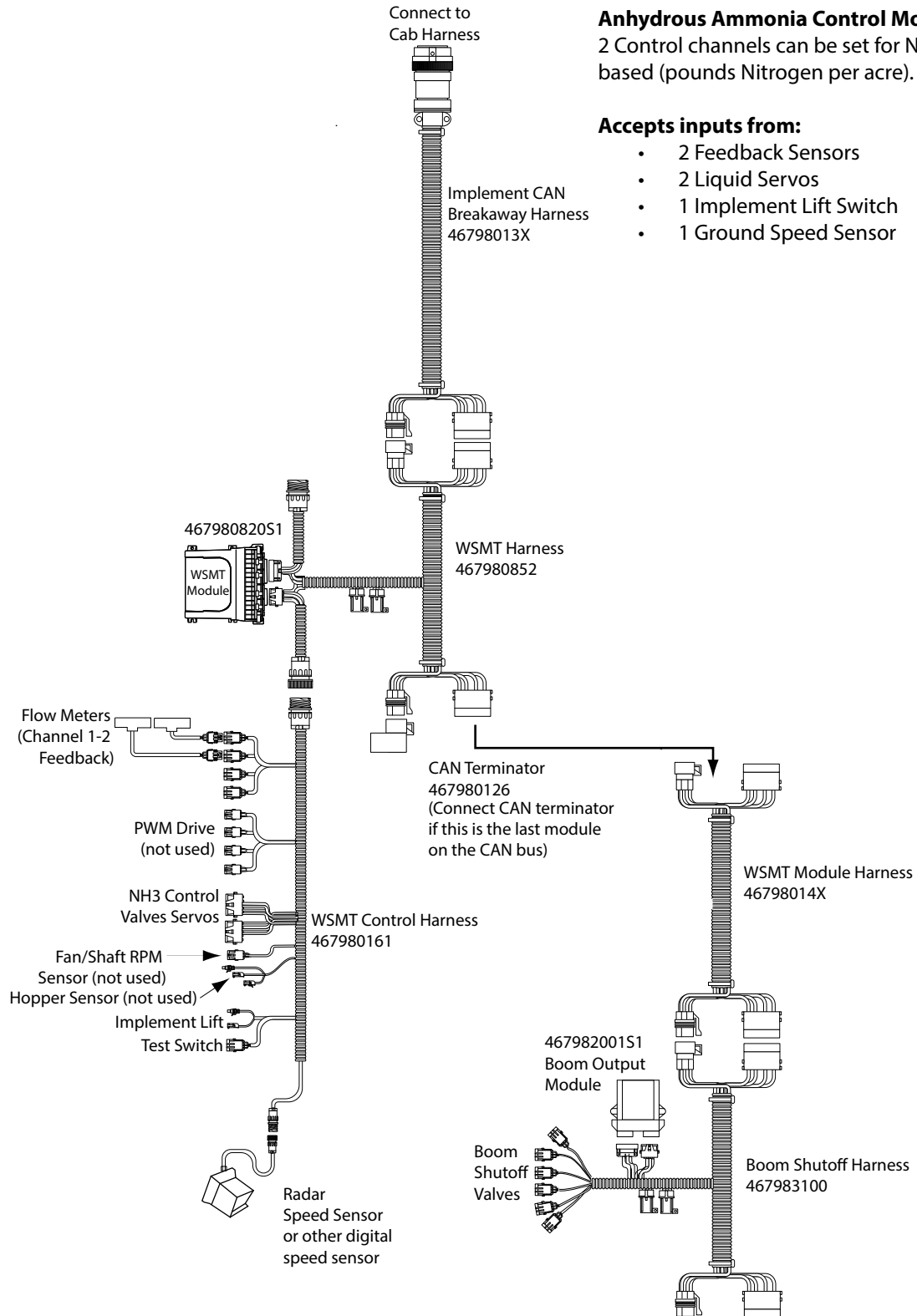

Anhydrous Ammonia Control Module

2 Control channels can be set for NH3 control/flow based (pounds Nitrogen per acre).

Accepts inputs from:

- 2 Feedback Sensors
- 2 Liquid Servos
- 1 Implement Lift Switch
- 1 Ground Speed Sensor

IntelliAg® WSMT2

-0161 Control Harness

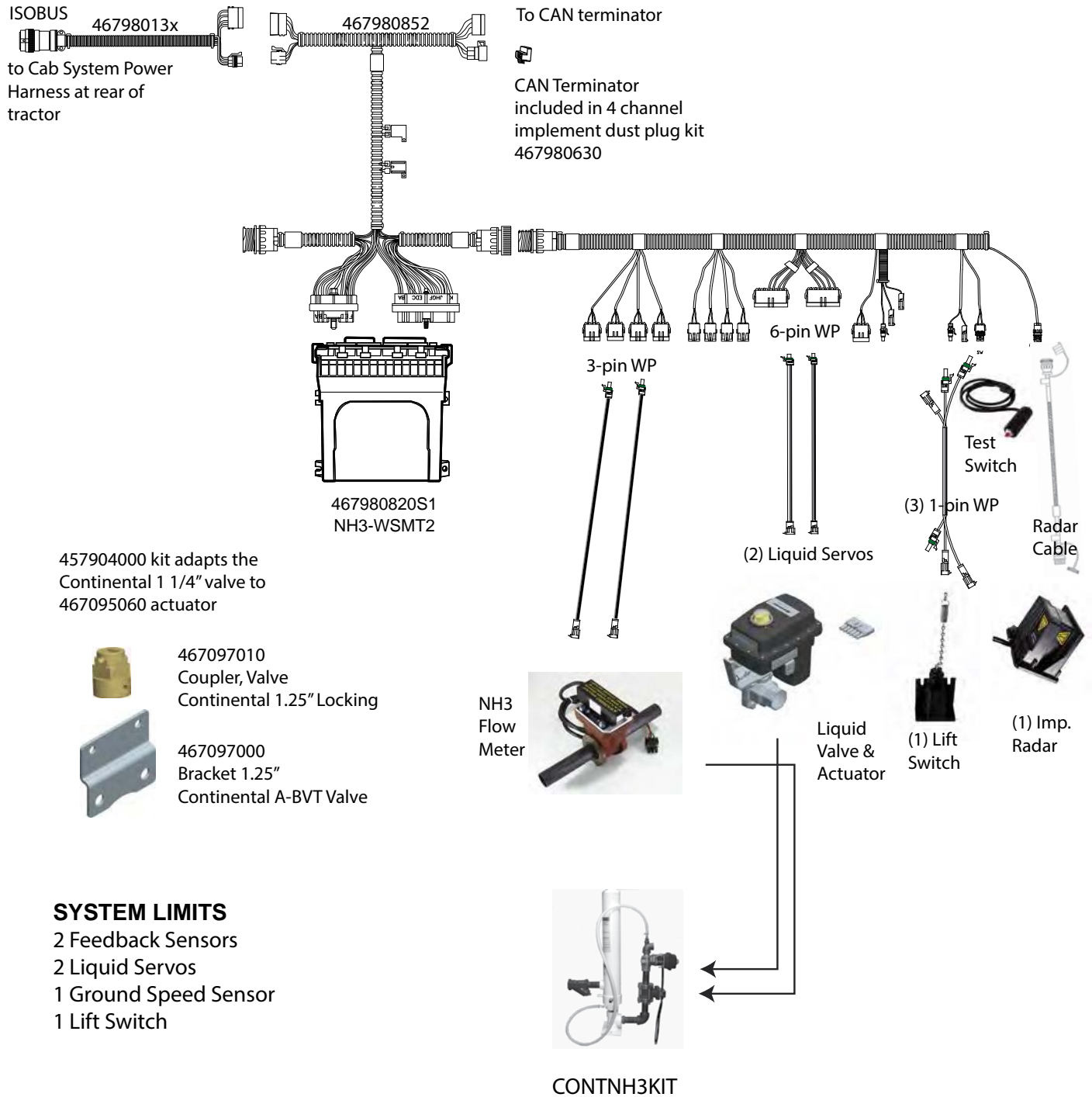

HITCH EXTENSIONS

Part Number	Description
467980134	Hitch Extension 6'
467980132	Hitch Extension 10'
467980136	Hitch Extension 15'
467980131	Hitch Extension 20'
467980133	Hitch Extension 30'
467980130	Hitch Extension 40'
467980135	Hitch Extension 50'
467980142	CAN Extension 5'
467980141	CAN Extension 10'
467980140	CAN Extension 20'
467980143	CAN Extension 25'
467980144	CAN Extension 40'
467980146	CAN Extension 45'
467980820S1	WSMT
467980852	WSMT Harness
467980630	4 Ch. Imp. Dust Plug Kit w/Terminator
1100110099	Ty Wrap Bundle 100 14"
110011466	Anhydrous Ammonia Ctrl User Manual
467980161	Control Harness

LIFT SWITCH AND RADAR

Part Number	Description
463720150S1	Implement Lift Switch
464820520S1	Lift Switch - Whisker Type
466820713	3-1Pin WP Ext. Cable 5'
466820712S1	3-1Pin WP Ext. Cable 10'
466820714	3-1Pin WP Ext. Cable 15'
466820710S3	3-1Pin WP Ext. Cable 20'
467831000S9	Radar III w/ 14' Cable & Mtg Brkt
439400024	Radar Extension 10'
439400065	Radar Extension 15'
439400064	Radar Extension 25'
464210515S1	Test Switch

ANHYDROUS KITS

Part Number	Description
CONTNH3KIT	NH3 Kit Continental 1-1/4" (9600 lbs/hr)
457904000	Continental 1-1/4" Actuator Adapter Kit

FLOW METER EXTENSIONS

Part Number	Description
457901810	3Pin WP Ext. Cable 15'
457901811	3Pin WP Ext. Cable 30'
457901812	3Pin WP Ext. Cable 45'

RAVEN FLOW METER ADAPTER

Part Number	Description
46698-0040S1	Raven FlowMTR Adapter

ACTUATOR EXTENSIONS

Part Number	Description
457901820	6Pin WP Extension Cable 15'
457901821	6Pin WP Extension Cable 30'

IntelliAg® WSMT2

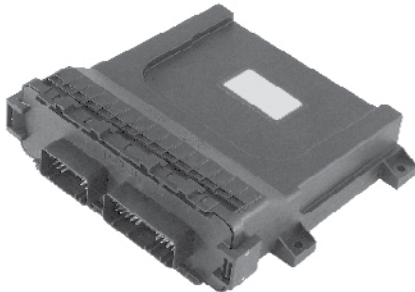

WSMT2

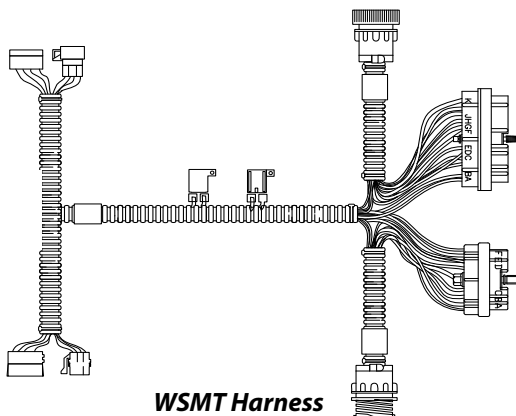

**WSMT Harness
467980852**



**Cab to Implement Harness Hitch Extension
46798013X**

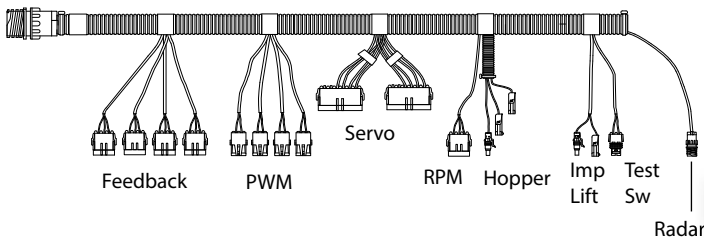

**Control Harness
467980161**

Working Set Master Module (WSMT2)

The Working Set Master Module (WSMT2) houses the system's primary interface device. All system parameters, constants, and memory are stored in the WSMT and controls the application of material by interfacing with proportional hydraulic valves and feedback sensors.

Working Set Master Module	
Part Number	Description
46798-0820S1	Module, NH3-WSMT2 (Anhydrous Ammonia Control)
46798-0630	4 Channel Implement Dust Plug Kit with Terminators
11011-0099	Ty Wrap Bundle 100 14 in.

Working Set Master Harness

WSMT Harnessing	
Part Number	Description
46798-0852	WSMT Harness 37-pin CPC connector with APER

Cab to Implement Harness Hitch Extension

Tractor Cab to Implement Harness Hitch Extensions	
Part Number	Description
46798-0134	6 ft. Hitch Extension ISO system CAN
46798-0132	10 ft. Hitch Extension ISO system CAN
46798-0136	15 ft. Hitch Extension ISO system CAN
46798-0131	20 ft. Hitch Extension ISO system CAN
46798-0133	30 ft. Hitch Extension ISO system CAN
46798-0130	40 ft. Hitch Extension ISO system CAN
46798-0135	50 ft. Hitch Extension
46798-0457	40 ft. Hitch to Hitch Extension

WSMT2 Harnesses (Control Channel/Accessory Inputs)

37-pin CPC Control Harnesses	
Part Number	Description
46798-0161	WSMT Material Application 4 Ch Actuator Harness with APER (application error rate)

Implement Kit

IANH3IMPKIT Anhydrous Ammonia Control Implement Kit Includes	
Part Number	Description
46798-0820S1	Module, NH3-WSMT2 (Anhydrous Ammonia Control)
46798-0852	WSMT Harness 37-pin CPC connector with APER (Material Application)
46798-0161	Control Harness
46798-0630	4 Channel Implement Dust Plug Kit with Terminators
11001-1466A	Operator's Manual

IntelliAg® WSMT2

CAN to Hitch Harnessing

Harness accommodates disconnection between implement and tow-behind aircart to second hitch extension.

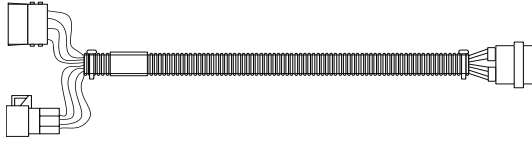

**Rear Implement Hitch Harness (Deutsch)
467980360**



**Rear Implement Hitch Harness (IBBC)
467980361**

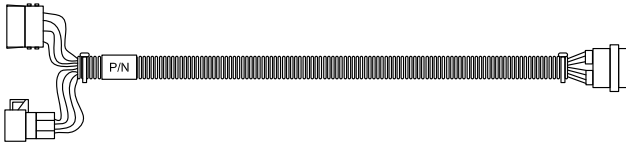

**Rear Implement Hitch Harness (IBBC)
467980362**

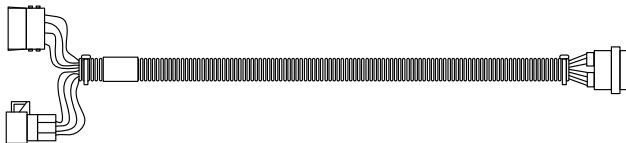

**Rear Implement Hitch Harness (IBBC)
467980363**

Rear Implement Hitch Harness	
Part Number	Description
46798-0360	Rear Implement Hitch Harness with Deutsch 9-pin (CAN to Hitch) 3 ft.
46798-0361	Rear Implement Hitch Harness with IBBC 9-pin (CAN to Hitch) 6 ft.
46798-0362	Rear Implement Hitch Harness with IBBC 9-pin 20 ft.
46798-0363	Rear Implement Hitch Harness with IBBC 9-pin 25 ft.

IntelliAg® WSMT2

Radar Y Harnessing

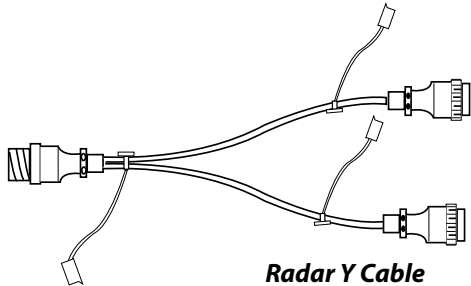

**Radar Y Cable
152950002**

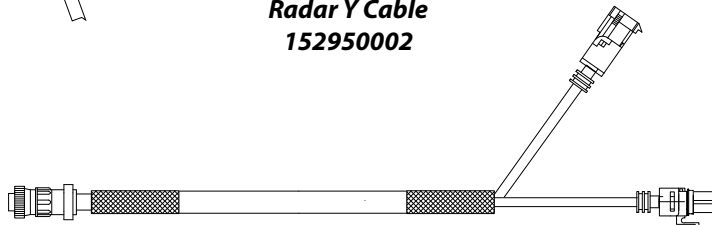

**Radar Y Cable
456404670**



**Radar Y Cable
456402530S3**

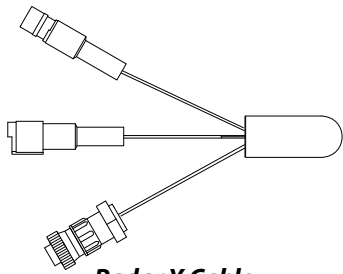

**Radar Y Cable
456403030**

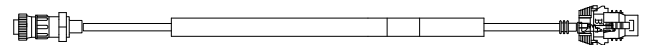

**Radar Y Cable
456404810**

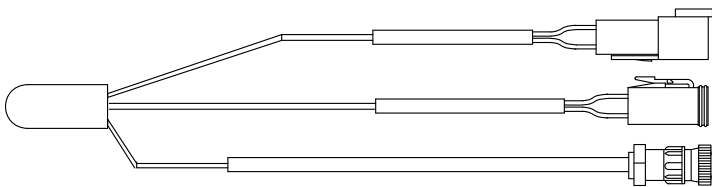

**Radar Y Cable
456404360S1**

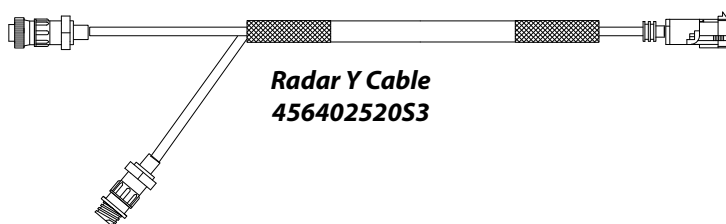

**Radar Y Cable
456402520S3**

Adapter Harness	
Part Number	Description
15295-0002	Radar Y Cable for Case Magnum 7110-8950 Series
45640-4670	Radar Y Cable for Case Maxum 5110-5240, MX90-170 Series, Steiger 9110-9390, 9210-9390 Series, Case STX 275-450 Series
45640-3030	Radar Y Cable for Caterpillar 65A, 65B, 75B Series
45640-4360S1	Radar Y Cable for 35, 45, 55, C, D, E Series
45640-2520S3	Radar Y Cable for John Deere 4xxx, 7xxx, 80xx Series
45640-2530S3	Radar Y Cable for John Deere 7600-8010T
45640-4810	Radar Y Cable for John Deere 8300 and 9400 Series

IntelliAg® WSMT2

Hitch and CAN Harness

P/N 46798013X, 46798014X, 46798036X

Hitch and CAN
46798013x, 46798014x & 46798036x

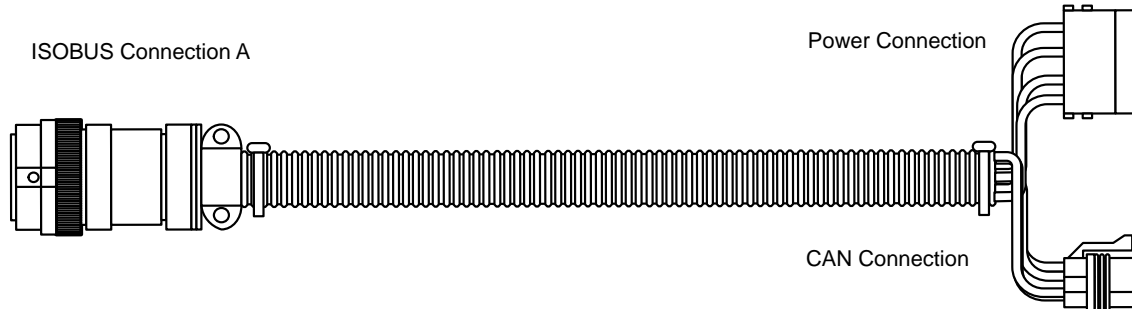

ISOBUS Connection A

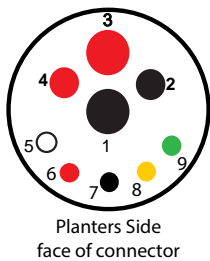

Pin	Function CONN A
1	Sol Ground
2	Ground
3	Sol Power +12V
4	Power +12V
5	
6	CAN Power +12V
7	CAN Ground
8	Signal High ~+2.6v
9	Signal Low ~+2.6v

Pin	Function PWR CONN
A	Sol Power +12V
B	Sol Ground
C	Power +12V
D	Ground

Pin	Function CAN CONN
A	
B	CAN Power +12V
C	
D	CAN Ground
E	Signal High ~+2.6v
F	Signal Low ~+2.6v

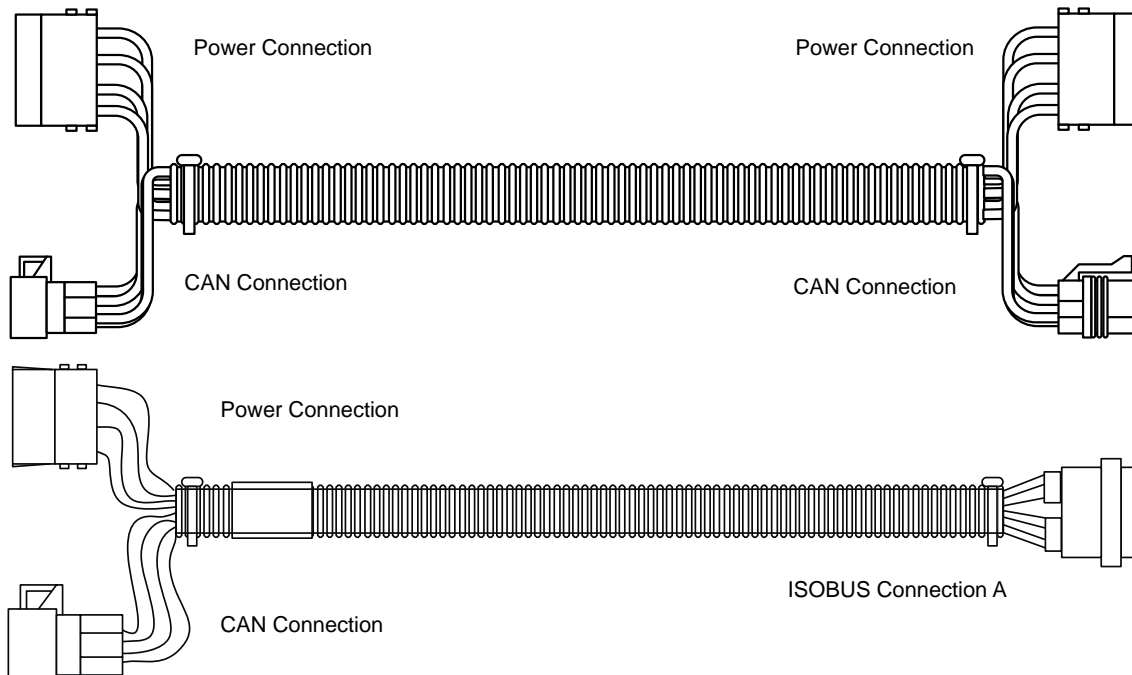

IntelliAg® WSMT2

Control Harness P/N 467980160

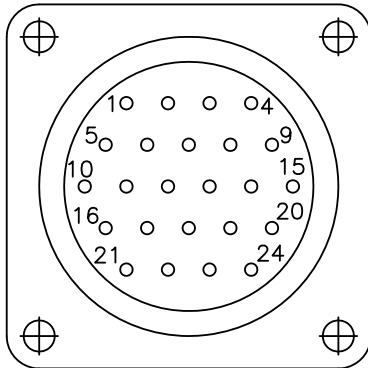
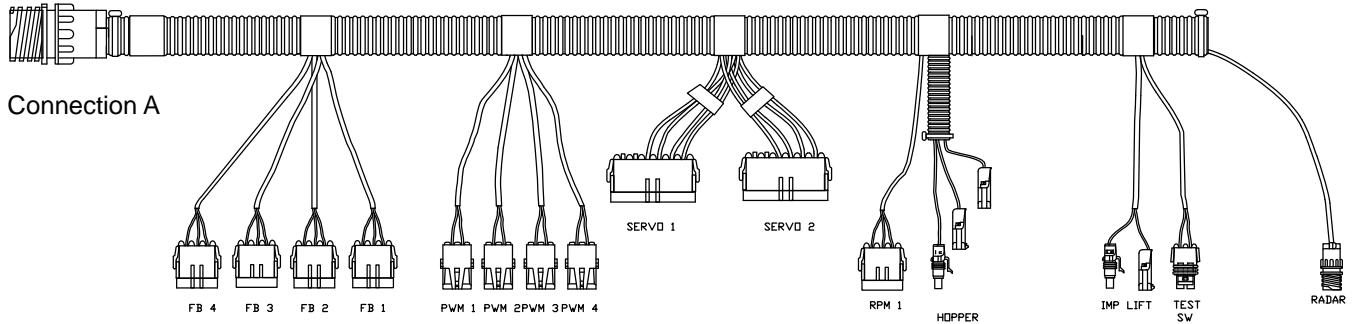

MATING SIDE VIEW

Pin	Function CONN A
1	Sol Ground
2	Sol Power+12V
3	+8V Supply
4	PWM 1
5	PWM 2
6	PWM 3
7	Servo 1 (relay 1)
8	Servo 1 (relay 2)
9	Servo 2 (relay 3)
10	Servo 2 (relay 4)
11	PWM 4
12	Feedback 1 Signal
13	Feedback 2 Signal
14	Feedback 3 Signal
15	RPM 1 Signal
16	Hopper 1 Signal
17	Ground Speed Signal
18	Feedback 4 Signal
19	ECU Power +12V
20	ECU Ground
21	Implement Lift
22	
23	
24	

Pin	Function SERVO 1
A	Sol Power+12V
B	Sol Ground
C	Servo 1 (relay 1)
D	Servo 1 (relay 2)
E	
F	

Pin	Function SERVO 2
A	Sol Power+12V
B	Sol Ground
C	Servo 2 (relay 3)
D	Servo 2 (relay 4)
E	
F	

IntelliAg® WSMT2

Control Harness
P/N 467980161

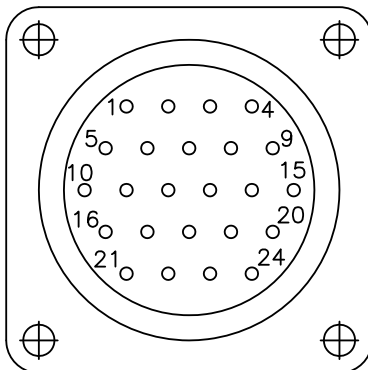
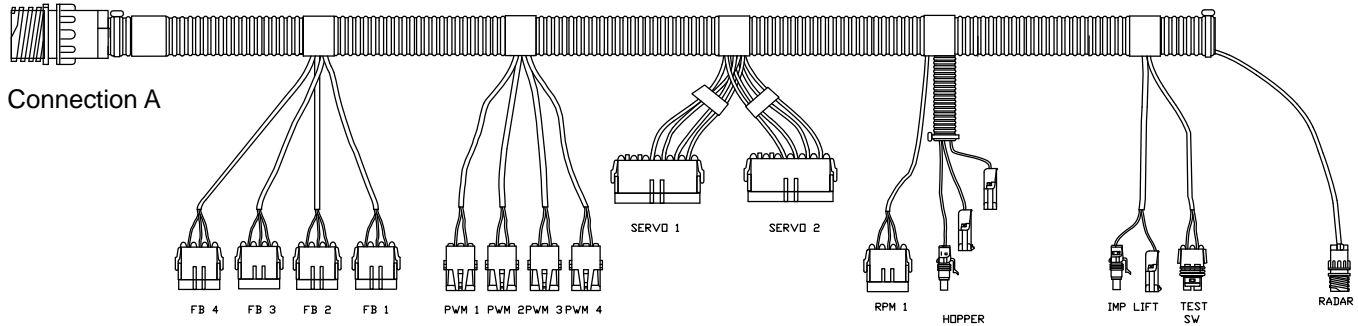

MATING SIDE VIEW

Pin	Function CONN A
1	Sol Ground
2	Sol Power+12V
3	+8V Supply
4	PWM 1
5	PWM 2
6	PWM 3
7	Servo 1 (relay 1)
8	Servo 1 (relay 2)
9	Servo 2 (relay 3)
10	Servo 2 (relay 4)
11	PWM 4
12	Feedback 1 Signal
13	Feedback 2 Signal
14	Feedback 3 Signal
15	RPM 1 Signal
16	Hopper 1 Signal
17	Ground Speed Signal
18	Feedback 4 Signal
19	ECU Power +12V
20	ECU Ground
21	Implement Lift
22	Servo 1 (DIG IN #11)
23	Servo 2 (DIG IN #16)
24	

Pin	Function SERVO 1
A	Sol Power+12V
B	Sol Ground
C	Servo 1 (relay 1)
D	Servo 1 (relay 2)
E	Servo 1 (DIG IN #11)
F	

Pin	Function SERVO 2
A	Sol Power+12V
B	Sol Ground
C	Servo 2 (relay 3)
D	Servo 2 (relay 4)
E	Servo 2 (DIG IN #16)
F	

IntelliAg® WSMT2

Control Harness 2 Ch
 P/N 467980162

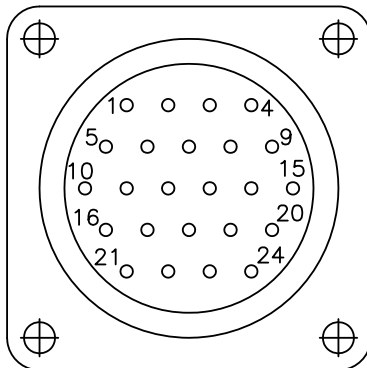
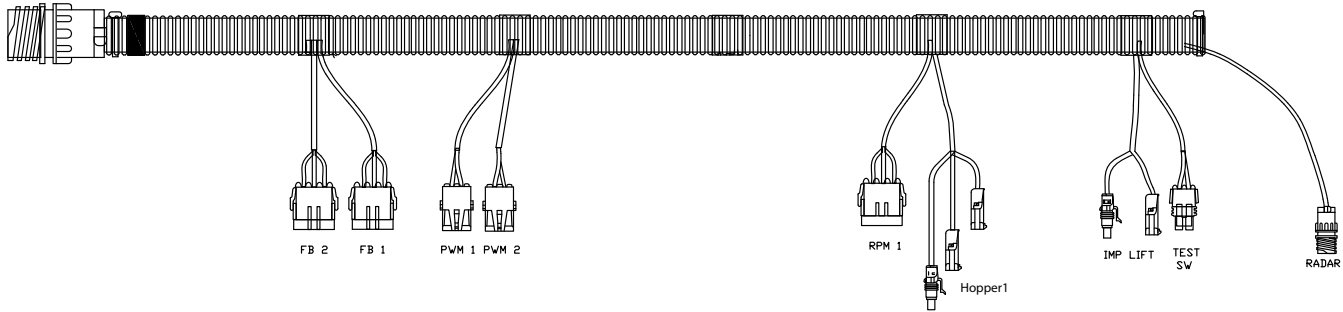

MATING SIDE VIEW

Pin	Function CONN A
1	
2	Power+12V PWM
3	+8V Supply
4	PWM 1
5	PWM 2
6	
7	
8	
9	
10	
11	
12	Feedback 1 Signal
13	Feedback 2 Signal
14	
15	RPM
16	Hopper 1 Signal
17	Ground Speed Signal
18	
19	Power +12V
20	Ground
21	Implement Lift
22	
23	
24	

IntelliAg® WSMT2

Control Harness 4 ch
P/N 467980164

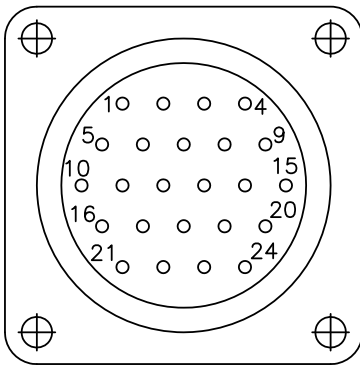
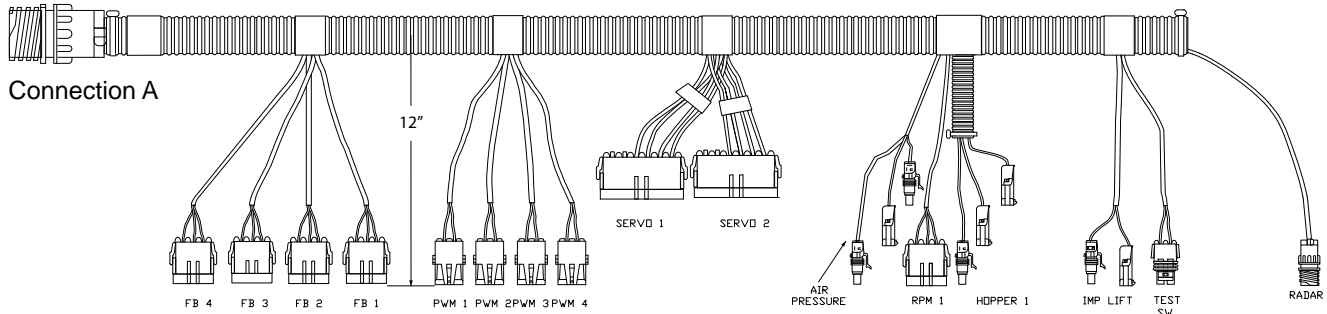

MATING SIDE VIEW

Pin	Function CONN A
1	Sol Ground
2	Sol Power+12V
3	+8V Supply
4	PWM 1
5	PWM 2
6	PWM 3
7	Servo 1 (OPEN)
8	Servo 1 (CLOSE)
9	Servo 2 (OPEN)
10	Servo 2 (CLOSE)
11	PWM 4
12	Feedback 1 Signal
13	Feedback 2 Signal
14	Feedback 3 Signal
15	RPM / Pressure Signal 1
16	Hopper 1 Signal
17	Ground Speed Signal
18	Feedback 4 Signal
19	ECU Power +12V
20	ECU Ground
21	Implement Lift
22	APER 1
23	APER 2
24	

Pin	Function SERVO 1
A	Sol Power+12V
B	Sol Ground
C	Servo 1 (relay 1)
D	Servo 1 (relay 2)
E	APER 1
F	

Pin	Function SERVO 2
A	Sol Power+12V
B	Sol Ground
C	Servo 2 (relay 3)
D	Servo 2 (relay 4)
E	APER 2
F	

IntelliAg® WSMT2

Control Harness (Monitor Only) P/N 467980165

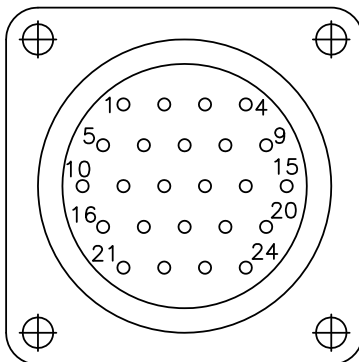
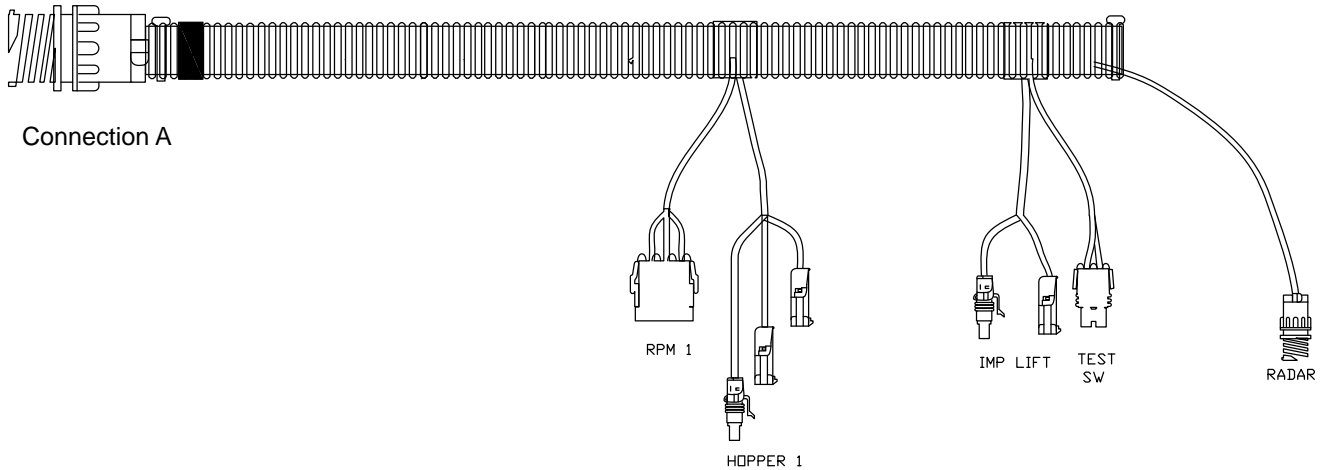

Pin	Function CONN A
1	
2	
3	+8V Supply
4	
5	
6	
7	
8	
9	
10	
11	
12	
13	
14	
15	RPM Signal
16	Hopper 1 Signal
17	Ground Speed Signal
18	
19	Power +12V
20	Ground
21	Implement Lift
22	
23	
24	

IntelliAg® WSMT2

Accessory Harness
P/N 467980201

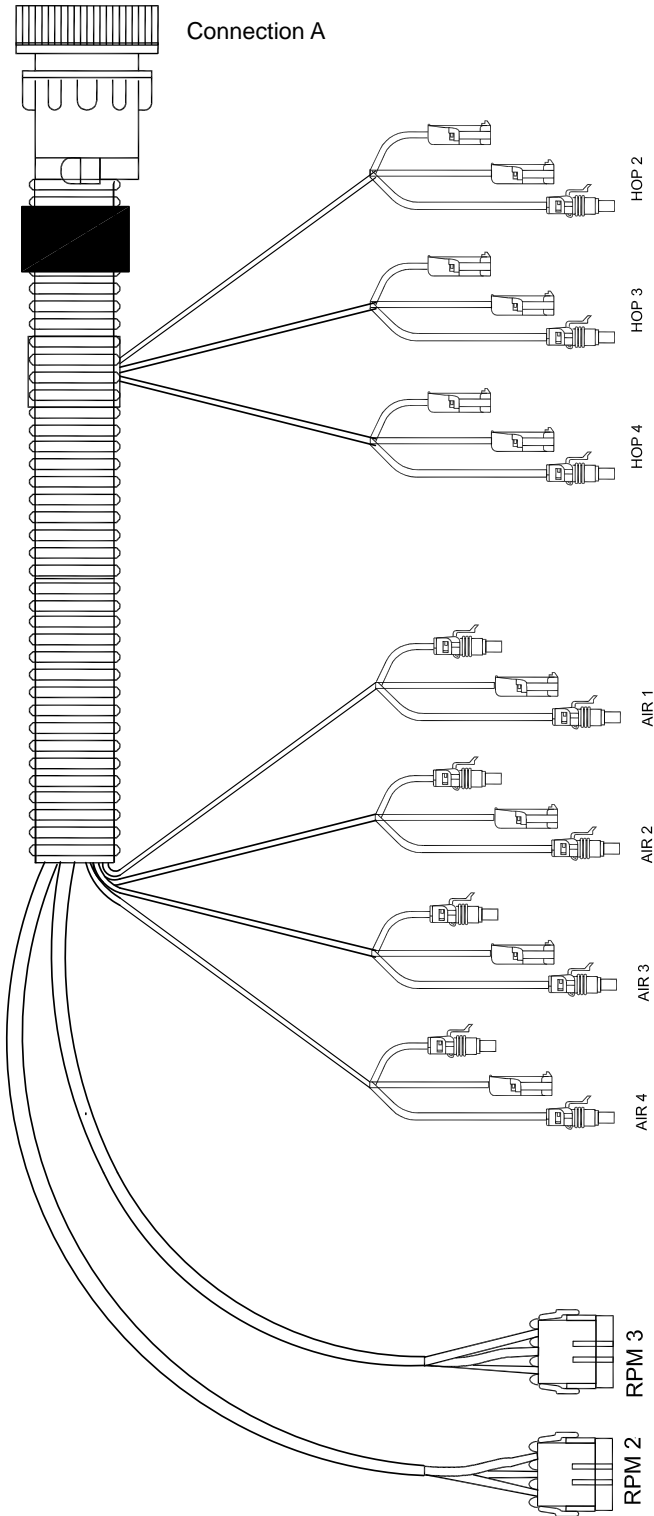

Pin	Function CONN A
1	RPM 2
2	RPM 3
3	Hopper 2
4	Hopper 3
5	Hopper 4
6	
7	Air Pressure 1
8	Air Pressure 2
9	Air Pressure 3
10	Air Pressure 4
11	
12	
13	
14	
15	
16	
17	
18	
19	
20	
21	
22	
23	
24	Power Air 1-4 +12V
25	Power Hopper 2-4 +8V
26	Ground Air & RPM
27	Ground Hopper 2-4
28	
29	
30	
31	
32	
33	
34	Power RPM +12V
35	
36	
37	

IntelliAg® WSMT2

Accessory Harness P/N 467980202

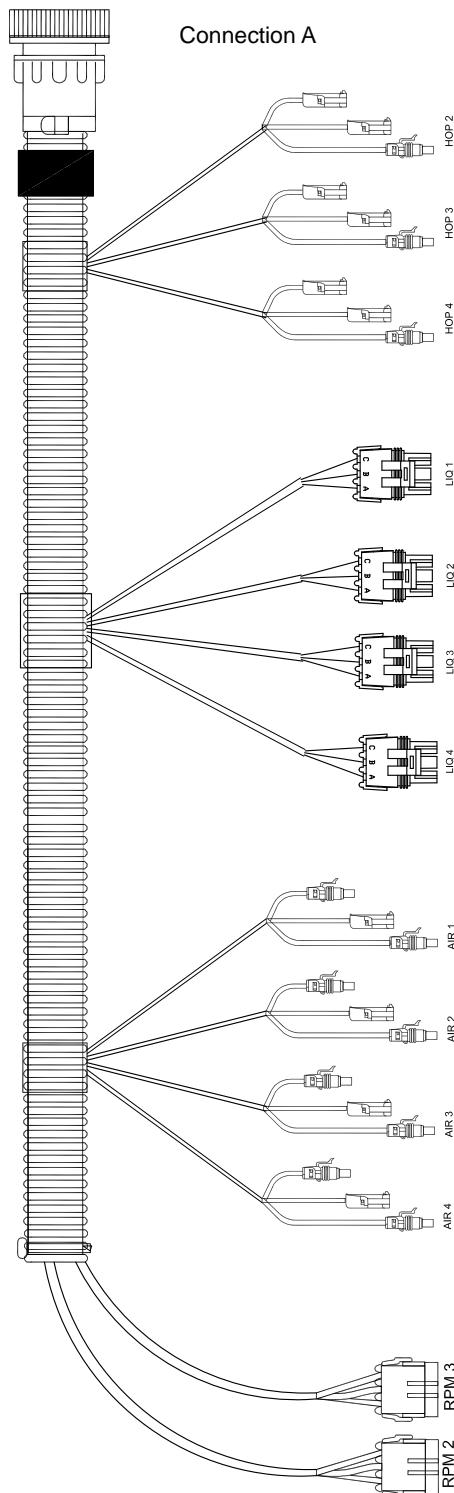

Pin	Function CONN A
1	RPM 2
2	RPM 3
3	Hopper 2
4	Hopper 3
5	Hopper 4
6	
7	Air Pressure 1
8	Air Pressure 2
9	Air Pressure 3
10	Air Pressure 4
11	
12	
13	Liquid 1
14	Liquid 2
15	Liquid 3
16	Liquid 4
17	
18	
19	
20	
21	
22	
23	
24	Power Air 1-4 +12V
25	Power Hopper 2-4 +8V
26	Ground Air & RPM
27	Ground Hopper & Liquid
28	
29	
30	
31	
32	
33	
34	Power Liquid & RPM +12V
35	
36	
37	

IntelliAg® WSMT2

*BSM/ESM Harness
P/N 467980330, 467980340*

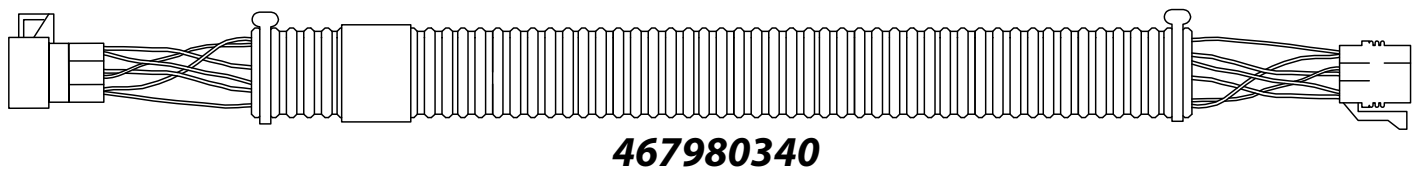
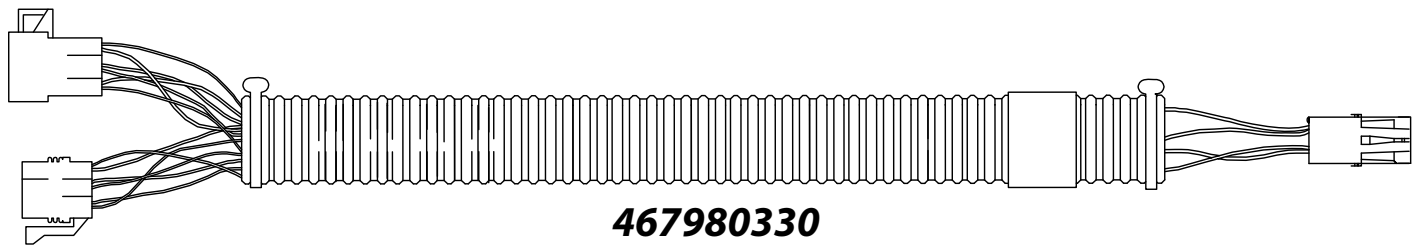

Color	Function
Red	Power+12V
Black	Ground
Yellow	Signal High ~+2.6v
Green	Signal Low ~+2.6v

IntelliAg® WSMT2

Electric Motor Driver Power Harness
 P/N 467980390

Connection A Connection B

Connection A		
Pin	Color	Function
A	Red	Sol Power +12V
B	Black	Sol Ground
C	Red	Power +12V
D	Black	Ground

Connection A		
Pin	Color	Function
A	Red	Sol Power +12V
B	Black	Sol Ground
C	Red	Power +12V
D	Black	Ground

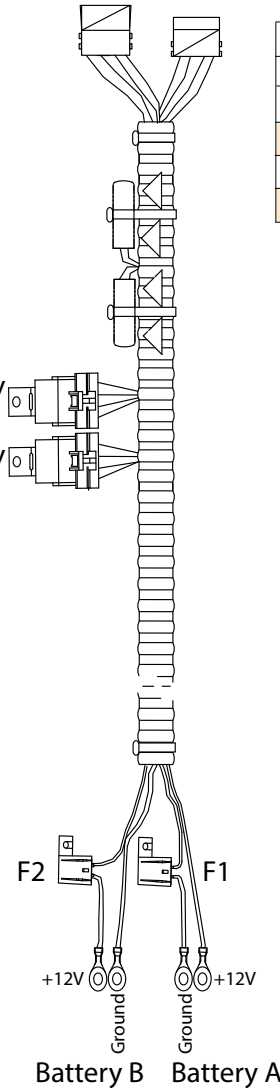

K1 Relay		
Pin	Function	Contact
A	Connector A +12V	85
B	Connector A ground	86
	Battery Pwr A +12V	30
A	Connector B	87

K2 Relay		
Pin	Function	Contact
C	Connector A +12V	85
D	Connector A Ground	86
	Battery Pwr B +12V	30
C	Connector B	87

IntelliAg® WSMT2

Cab Harness
P/N 467980451A

Pin	Function CONN C
A	ECU Power
B	CAN Power
C	ECU Ground
D	CAN Ground
E	CAN High
F	CAN Low

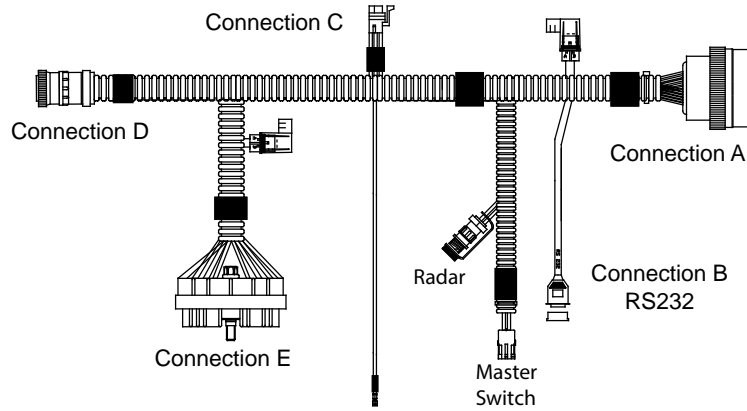

Pin	Function CONN E
A1	ECU Power
A2	Solenoid Power
A3	
B1	Solenoid Ground
B2	ECU Ground
B3	ECU Ground
C1	Master Switch
C2	
C3	ECU Relay
D1	Solenoid Relay
D2	Radar Signal
D3	
E1	
E2	
E3	
F1	
F2	
F3	
G1	
G2	
G3	CAN Signal High
H1	CAN Signal Low
H2	
H3	
J1	
J2	
J3	
K1	Continuous Power
K2	
K3	Ignition

Pin	Function CONN B
1	
2	TXD Transmitted Data
3	RXD Received Data
4	
5	Signal Ground
6	
7	CTS Clear to Send
8	RTS Request to Send
9	

Pin	Function CONN D
1	ECU Relay
2	ECU Power
3	Continuous Power
4	Solenoid Relay
5	ECU Ground
6	Boom Control Power
7	Boom Control Ground
8	CAN High
9	CAN Low
10	ECU Power Sense
11	Solenoid Power Sense
12	Solenoid Ground Sense
13	
14	
15	
16	

Pin	Function CONN A
1	Signal Ground
2	
3	
4	
5	ECU Ground
6	
7	TXD Transmitted Data
8	
9	Ignition Power
10	RXD Received Data
11	CTS Clear to Send
12	
13	
14	
15	
16	
17	CAN High
18	
19	
20	Continuous Power
21	
22	
23	
24	
25	
26	
27	
28	CAN Low
29	
30	RTS Request to Send
31	

IntelliAg® WSMT2

Power Harness
P/N 467980455

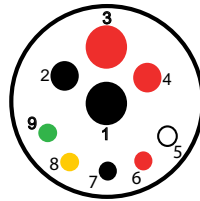
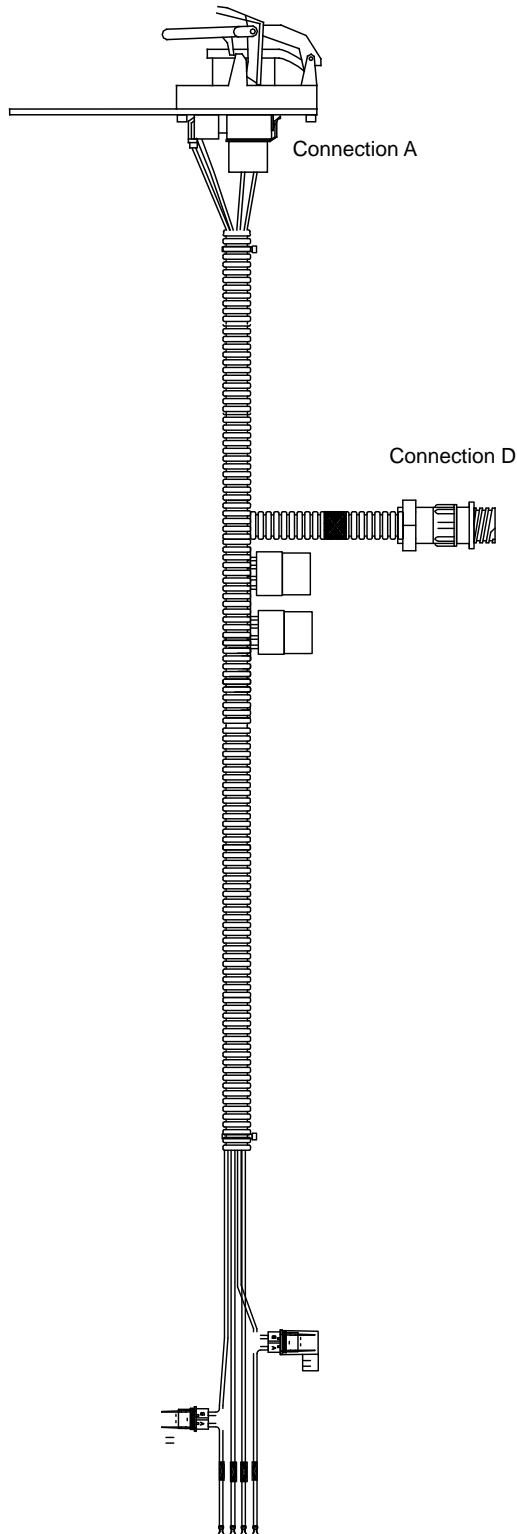

Pin	Function CONN A
1	Sol Ground
2	Ground
3	Sol Power +12V
4	Power
5	
6	CAN Power +12V
7	CAN Ground
8	Signal High ~+2.6v
9	Signal Low ~+2.6v

Pin	Function CONN D
1	ECU Relay
2	ECU Power
3	Continuous Power
4	Solenoid Relay
5	ECU Ground
6	CAN Power
7	CAN Ground
8	CAN High
9	CAN Low
10	ECU Power Sense
11	Solenoid Power Sense
12	Solenoid Ground Sense
13	
14	
15	
16	

IntelliAg® WSMT2

Electric Motor Driver Harness
P/N 467980490

Connection A		
Pin	Color	Function
A	Red	Sol Power + 12V
B	Black	Sol Ground
C	Red	Power + 12V
D	Black	Ground

Connection B		
Pin	Color	Function
A	Red	Sol Power + 12V
B	Black	Sol Ground
C	Red	Power + 12V
D	Black	Ground

R1		
Pin	Function	Contact
A	Connection A Sol Power	30
A	Control	85
B	Connection A/B	86
B	Load	86
30	K1	87

K1		
Pin	Function	Contact
87	R1	30
B	Connection A/B	85
B	Control (ground)	86
A	Load	87

F1
F1 Fuse Holder
Solenoid Power

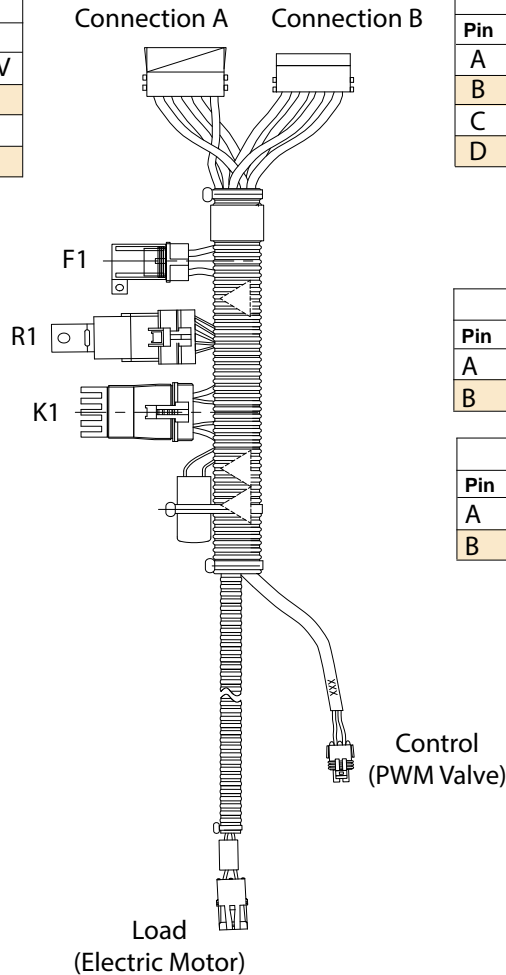

Load		
Pin	Color	Function
A	Red	Power
B	Black	Ground

Control		
Pin	Color	Function
A	Red	Power
B	Black	Ground

IntelliAg® WSMT2

WSMT 'T' Harness P/N 467980850

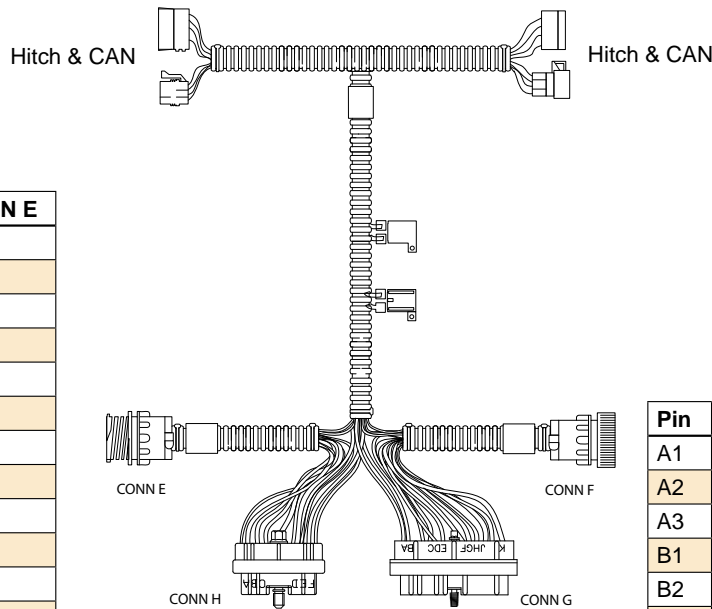

Pin	Function CONN E
1	DIG Input #1
2	DIG Input #2
3	DIG Input #3
4	DIG Input #4
5	DIG Input #5
6	DIG Input #6
7	DIG Input #7
8	DIG Input #8
9	DIG Input #9
10	DIG Input #10
11	DIG Input #11
12	DIG Input #16
13	ANG/DIG Input 1A
14	ANG/DIG Input 2A
15	ANG/DIG Input 3A
16	ANG/DIG Input 4A
17	
18	
19	
20	
21	
22	
23	
24	+8V or +5V Power
25	+8V or +5V Power
26	ECU Ground
27	ECU Ground
28	
29	
30	
31	
32	
33	
34	ECU Power +12V
35	
36	
37	REL/DIG Input 1R

Pin	Function CONN F
1	Solenoid Ground
2	Solenoid Power
3	+8V or +5V Supply
4	PWM Power Driver 1
5	PWM Power Driver 2
6	PWM Power Driver 3
7	Relay Driver 1
8	Relay Driver 2
9	Relay Driver 3
10	Relay Driver 4
11	PWM Power Driver 4
12	DIG Input 13
13	DIG Input 14
14	DIG Input 15
15	REL/DIG Input 2R
16	REL/DIG Input 3R
17	REL/DIG Input 1R
18	DIG Input 12
19	ECU Power +12V
20	ECU Ground
21	Imp Lift/Test Switch
22	
23	
24	

Pin	Function CONN H
1A	DIG Input #1
2A	DIG Input #6
3A	DIG Input #11
1B	DIG Input #2
2B	DIG Input #7
3B	ANG/DIG Input 1A
1C	DIG Input #3
2C	ANG/DIG Input 3A
3C	ECU Ground
1D	DIG Input #4
2D	ANG/DIG Input 4A
3D	+8V or +5V Power
1E	DIG Input #5
2E	DIG Input #16
3E	ANG/DIG Input 2A
1F	DIG Input #8
2F	DIG Input #9
3F	DIG Input #10

Pin	Function CONN G
A1	Relay Driver 1
A2	DIG Input #12
A3	REL/DIG Input 1R
B1	PWM Power Driver 1
B2	CAN Low
B3	REL/DIG Input 2R
C1	Relay Driver 2
C2	CAN High
C3	REL/DIG Input 3R
D1	PWM Power Driver 3
D2	DIG Input #1/Imp Lift
D3	DIG Input #13
E1	DIG Input #15
E2	DIG Input #14
E3	+8V or +5V Power
F1	ECU Power +12V
F2	DIG Input #16
F3	ECU Ground
G1	Relay Driver 4
G2	Ground
G3	DIG Input #11
H1	Relay Driver 3
H2	Ground
H3	Ground
J1	PWM Power Driver 2
J2	
J3	Solenoid Power
K1	PWM Power Driver 4
K2	Solenoid Power +12V
K3	Solenoid Power

IntelliAg® WSMT2

WSMT 'T' Harness
P/N 467980851

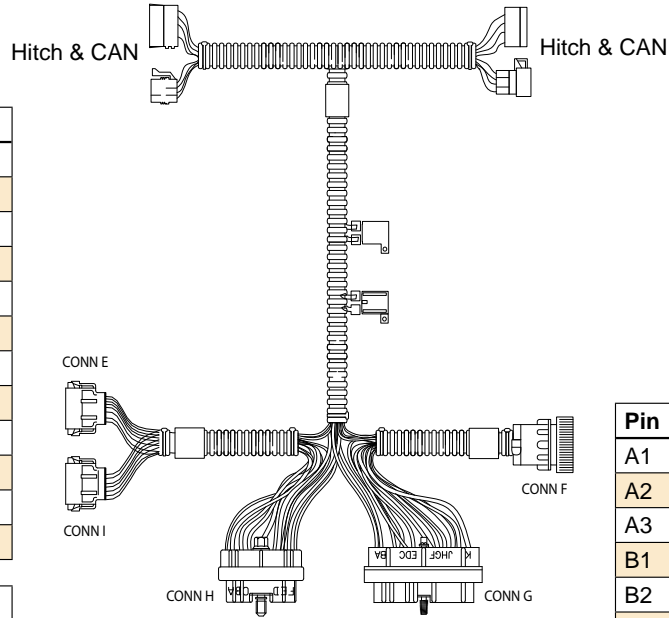

Pin	Function CONN E
1	PLUG
2	PLUG
3	PLUG
4	PLUG
5	ANG/DIG Input 1A
6	ANG/DIG Input 2A
7	ANG/DIG Input 3A
8	ANG/DIG Input 4A
9	+8V or +5V Supply
10	ECU Ground
11	PLUG
12	PLUG

Pin	Function CONN I
1	DIG Input #1
2	DIG Input #2
3	DIG Input #3
4	DIG Input #4
5	DIG Input #5
6	DIG Input #6
7	DIG Input #7
8	DIG Input #8
9	DIG Input #9
10	DIG Input #10
11	DIG Input #11
12	DIG Input #16

Pin	Function CONN F
1	Solenoid Ground
2	Solenoid Power
3	+8V or +5V Supply
4	PWM Power Driver 1
5	PWM Power Driver 2
6	PWM Power Driver 3
7	Relay Driver 1
8	Relay Driver 2
9	Relay Driver 3
10	Relay Driver 4
11	PWM Power Driver 4
12	DIG Input 13
13	DIG Input 14
14	DIG Input 15
15	REL/DIG Input 2R
16	REL/DIG Input 3R
17	REL/DIG Input 1R
18	DIG Input 12
19	ECU Power +12V
20	ECU Ground
21	Imp Lift/Test Switch
22	
23	
24	

Pin	Function CONN H
1A	DIG Input #1
2A	DIG Input #6
3A	DIG Input #11
1B	DIG Input #2
2B	DIG Input #7
3B	ANG/DIG Input 1A
1C	DIG Input #3
2C	ANG/DIG Input 3A
3C	ECU Ground
1D	DIG Input #4
2D	ANG/DIG Input 4A
3D	+8V or +5V Power
1E	DIG Input #5
2E	DIG Input #16
3E	ANG/DIG Input 2A
1F	DIG Input #8
2F	DIG Input #9
3F	DIG Input #10

Pin	Function CONN G
A1	Relay Driver 1
A2	DIG Input #12
A3	REL/DIG Input 1R
B1	PWM Power Driver 1
B2	CAN Low
B3	REL/DIG Input 2R
C1	Relay Driver 2
C2	CAN High
C3	REL/DIG Input 3R
D1	PWM Power Driver 3
D2	DIG Input #1
D3	DIG Input #13
E1	DIG Input #15
E2	DIG Input #14
E3	+8V or +5V Power
F1	ECU Power +12V
F2	PLUG
F3	ECU Ground
G1	Relay Driver 4
G2	Ground
G3	PLUG
H1	Relay Driver 3
H2	Ground
H3	Ground
J1	PWM Power Driver 2
J2	PLUG
J3	Solenoid Power
K1	PWM Power Driver 4
K2	Solenoid Power +12V
K3	Solenoid Power

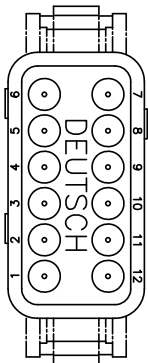

WIRE SIDE VIEW

IntelliAg® WSMT2

WSMT 'T' Harness
 P/N 467980852

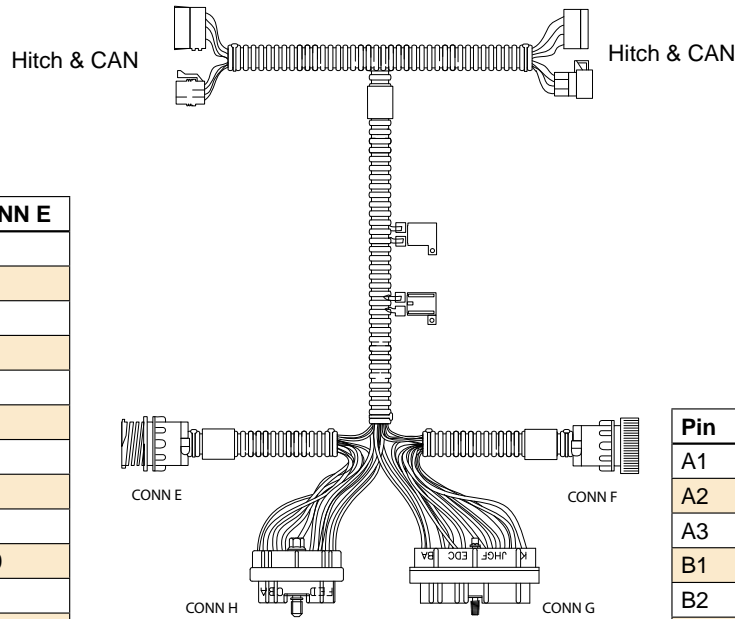

Pin	Function CONN E
1	DIG Input #1
2	DIG Input #2
3	DIG Input #3
4	DIG Input #4
5	DIG Input #5
6	PLUG
7	DIG Input #7
8	DIG Input #8
9	DIG Input #9
10	DIG Input #10
11	DIG Input #11
12	DIG Input #16
13	ANG/DIG Input 1A
14	ANG/DIG Input 2A
15	ANG/DIG Input 3A
16	ANG/DIG Input 4A
17	
18	
19	
20	
21	
22	
23	
24	+8V or +5V Power
25	+8V or +5V Power
26	ECU Ground
27	ECU Ground
28	
29	
30	
31	
32	
33	
34	ECU Power +12V
35	
36	
37	REL/DIG Input 1R

Pin	Function CONN F
1	Solenoid Ground
2	Solenoid Power
3	+8V or +5V Supply
4	PWM Power Driver 1
5	PWM Power Driver 2
6	PWM Power Driver 3
7	Relay Driver 1
8	Relay Driver 2
9	Relay Driver 3
10	Relay Driver 4
11	PWM Power Driver 4
12	DIG Input 13
13	DIG Input 14
14	DIG Input 15
15	REL/DIG Input 2R
16	REL/DIG Input 3R
17	REL/DIG Input 1R
18	DIG Input 12
19	ECU Power +12V
20	ECU Ground
21	Imp Lift/Test Switch
22	Appl Rate Error 1
23	Appl Rate Error 2
24	

Pin	Function CONN H
1A	DIG Input #1
2A	DIG Input #6
3A	DIG Input #11
1B	DIG Input #2
2B	DIG Input #7
3B	ANG/DIG Input 1A
1C	DIG Input #3
2C	ANG/DIG Input 3A
3C	ECU Ground
1D	DIG Input #4
2D	ANG/DIG Input 4A
3D	+8V or +5V Power
1E	DIG Input #5
2E	DIG Input #16
3E	ANG/DIG Input 2A
1F	DIG Input #8
2F	DIG Input #9
3F	DIG Input #10

Pin	Function CONN G
A1	Relay Driver 1
A2	DIG Input #12
A3	REL/DIG Input 1R
B1	PWM Power Driver 1
B2	CAN Low
B3	REL/DIG Input 2R
C1	Relay Driver 2
C2	CAN High
C3	REL/DIG Input 3R
D1	PWM Power Driver 3
D2	DIG Input #1
D3	DIG Input #13
E1	DIG Input #15
E2	DIG Input #14
E3	+8V or +5V Power
F1	ECU Power +12V
F2	Appl Rate Error 2
F3	ECU Ground
G1	Relay Driver 4
G2	Ground
G3	Appl Rate Error 1
H1	Relay Driver 3
H2	Ground
H3	Ground
J1	PWM Power Driver 2
J2	PLUG
J3	Solenoid Power
K1	PWM Power Driver 4
K2	Solenoid Power +12V
K3	Solenoid Power

IntelliAg® WSMT2

Accessory Harness
P/N 467980860

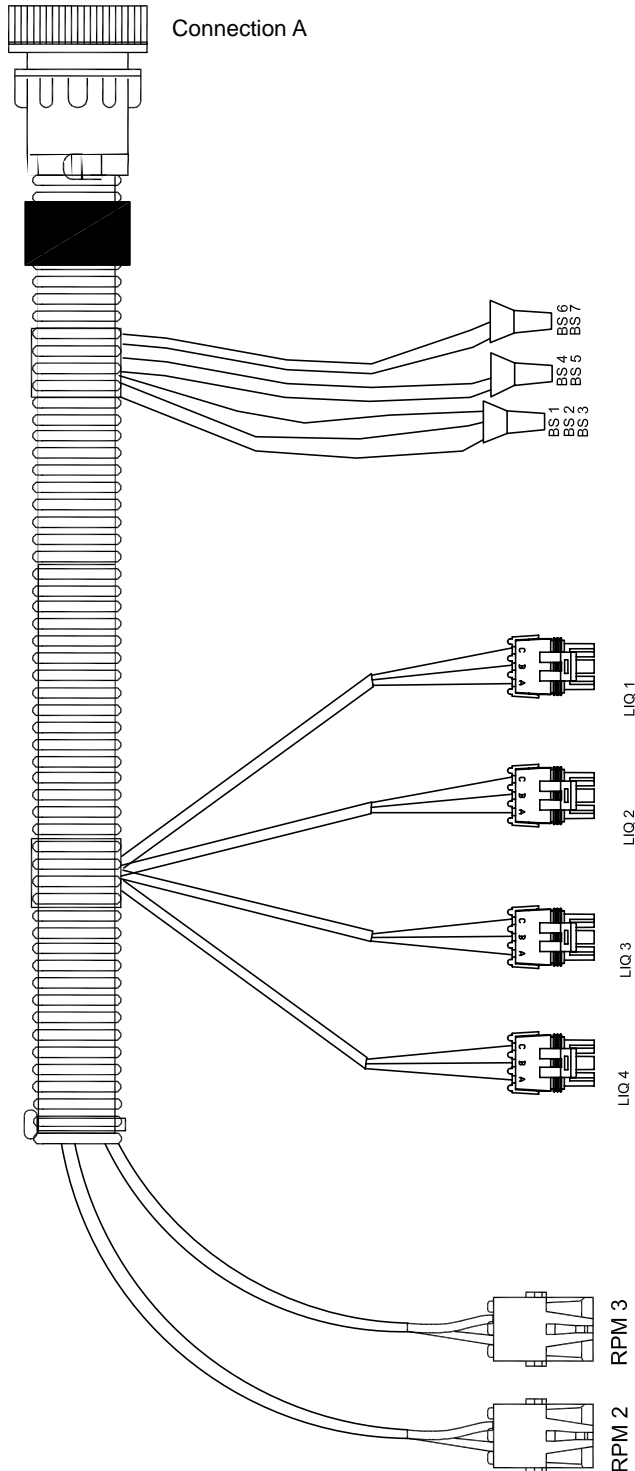

Pin	Function CONN A
1	RPM Signal 2
2	RPM Signal 3
3	Boom Sense 6
4	Boom Sense 7
5	Boom Sense 1
6	
7	Boom Sense 2
8	Boom Sense 3
9	Boom Sense 4
10	Boom Sense 5
11	
12	
13	Liquid Signal 1
14	Liquid Signal 2
15	Liquid Signal 3
16	Liquid Signal 4
17	
18	
19	
20	
21	
22	
23	
24	
25	
26	Ground
27	
28	
29	
30	
31	
32	
33	
34	Power +12V
35	
36	
37	

IntelliAg® WSMT2

Accessory Harness P/N 467980861

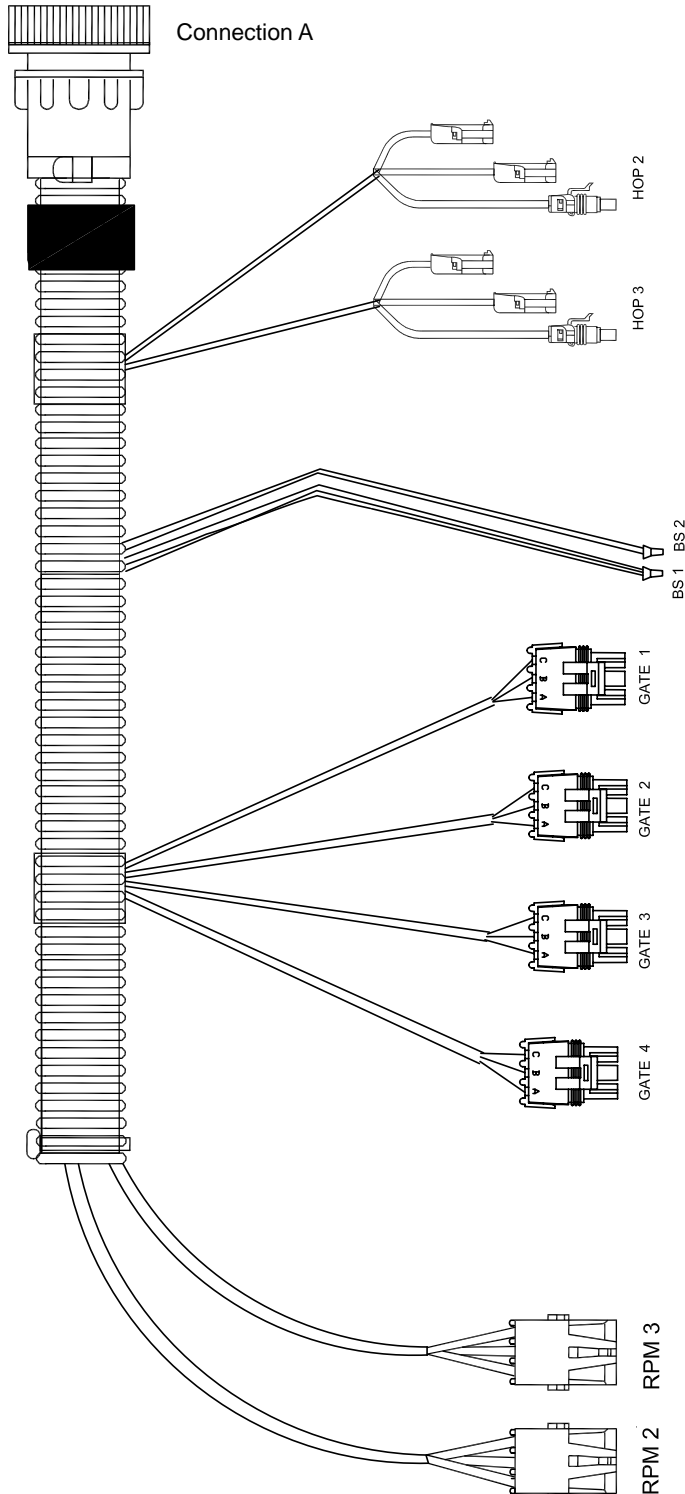

Pin	Function CONN A
1	RPM Signal 2
2	RPM Signal 3
3	Hopper Signal 2
4	Hopper Signal 3
5	Boom Sense 1
6	
7	Boom Sense 2
8	Boom Sense 3
9	Boom Sense 4
10	Boom Sense 5
11	
12	
13	Gate Signal 1
14	Gate Signal 2
15	Gate Signal 3
16	Gate Signal 4
17	
18	
19	
20	
21	
22	
23	
24	
25	Hopper Power
26	Gate & RPM Ground
27	Hopper Ground
28	
29	
30	
31	
32	
33	
34	Power Gate & RPM +12V
35	
36	
37	

IntelliAg® WSMT2

Working Set Member Harness
P/N 467981200

Pin	Function CONN E
1	DIG Input #1
2	DIG Input #2
3	DIG Input #3
4	DIG Input #4
5	DIG Input #5
6	DIG Input #6
7	DIG Input #7
8	DIG Input #8
9	DIG Input #9
10	DIG Input #10
11	DIG Input #11
12	DIG Input #12
13	DIG Input #13
14	DIG Input #14
15	DIG Input #15
16	DIG Input #16
17	DIG Input #17
18	DIG Input #18
19	
20	
21	
22	
23	
24	+8V or +5V Power
25	+8V or +5V Power
26	ECU Ground
27	ECU Ground
28	
29	
30	
31	
32	
33	
34	
35	
36	
37	

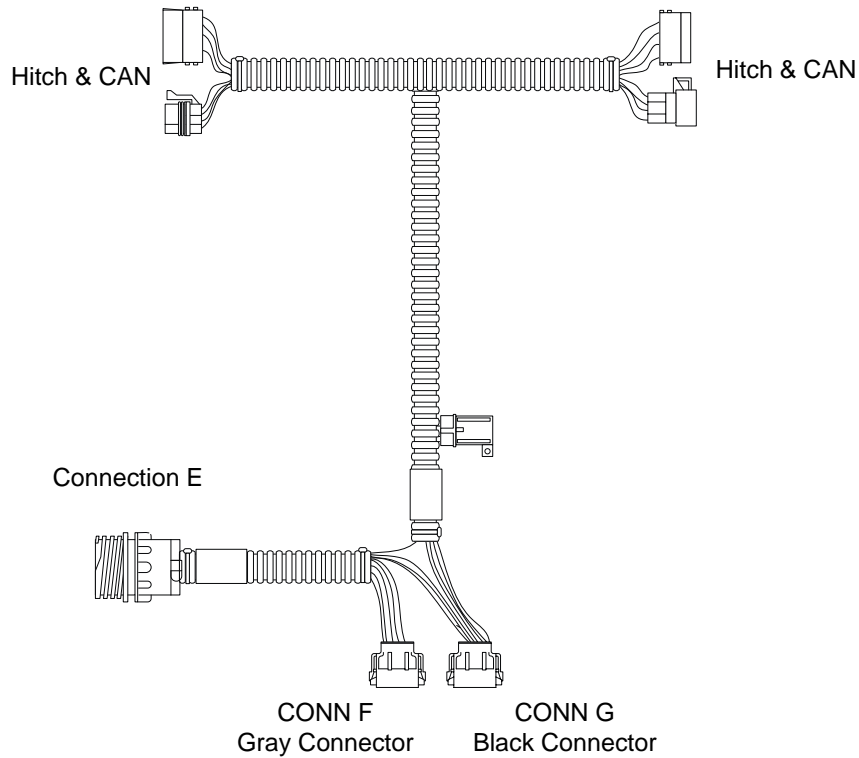

Pin	Function CONN F Gray Connector
1	DIG Input #1
2	DIG Input #2
3	DIG Input #3
4	DIG Input #4
5	DIG Input #5
6	DIG Input #6
7	DIG Input #7
8	DIG Input #8
9	DIG Input #9
10	DIG Input #10
11	DIG Input #11
12	DIG Input #12

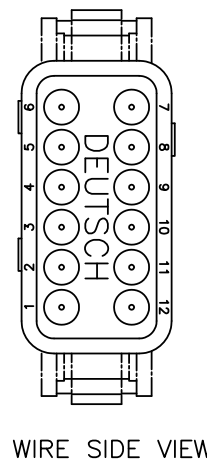

WIRE SIDE VIEW

Pin	Function CONN G Black Connector
1	DIG Input #13
2	DIG Input #14
3	DIG Input #15
4	DIG Input #16
5	DIG Input #17
6	DIG Input #18
7	CAN High
8	CAN Low
9	+8V or +5V Power
10	ECU Ground
11	ECU Power
12	ECU Ground

IntelliAg® WSMT2

Working Set Member Harness P/N 467981201

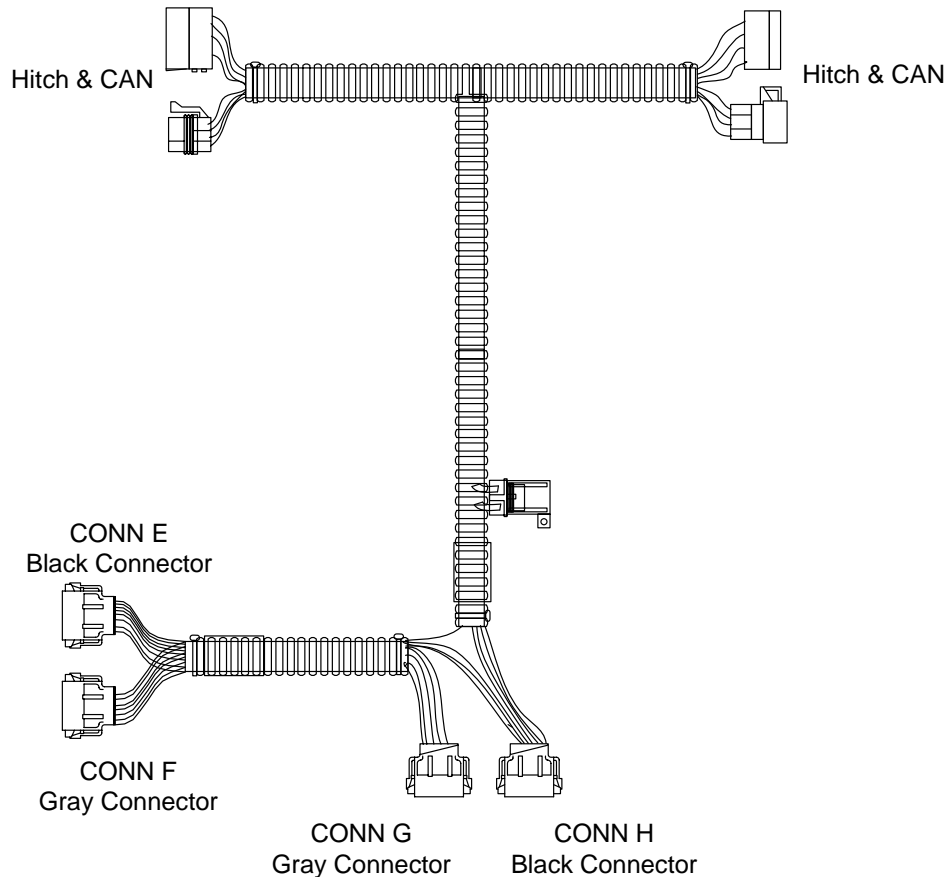

Pin	Function CONN E Black Connector
1	DIG Input #17
2	DIG Input #18
3	PLUG
4	PLUG
5	DIG Input #13
6	DIG Input #14
7	DIG Input #15
8	DIG Input #16
9	Power
10	Ground
11	PLUG
12	PLUG

Pin	Function CONN F Gray Connector
1	DIG Input #1
2	DIG Input #2
3	DIG Input #3
4	DIG Input #4
5	DIG Input #5
6	DIG Input #6
7	DIG Input #7
8	DIG Input #8
9	DIG Input #9
10	DIG Input #10
11	DIG Input #11
12	DIG Input #12

Pin	Function CONN G Gray Connector
1	DIG Input #1
2	DIG Input #2
3	DIG Input #3
4	DIG Input #4
5	DIG Input #5
6	DIG Input #6
7	DIG Input #7
8	DIG Input #8
9	DIG Input #9
10	DIG Input #10
11	DIG Input #11
12	DIG Input #12

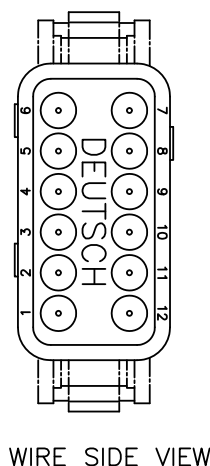

Pin	Function CONN H Black Connector
1	DIG Input #13
2	DIG Input #14
3	DIG Input #15
4	DIG Input #16
5	DIG Input #17
6	DIG Input #18
7	CAN High
8	CAN Low
9	+8V or +5V Power
10	ECU Ground
11	ECU Power
12	ECU Ground

IntelliAg® WSMT2

12 Row Shutoff Control Harness
P/N 467982100

Pin	Function
	RSO 1
A	Solenoid Power (+)
B	Solenoid Ground (-)
	RSO 2
A	Solenoid Power (+)
B	Solenoid Ground (-)
	RSO 3
A	Solenoid Power (+)
B	Solenoid Ground (-)
	RSO 4
A	Solenoid Power (+)
B	Solenoid Ground (-)
	RSO 5
A	Solenoid Power (+)
B	Solenoid Ground (-)
	RSO 6
A	Solenoid Power (+)
B	Solenoid Ground (-)
	RSO 7
A	Solenoid Power (+)
B	Solenoid Ground (-)
	RSO 8
A	Solenoid Power (+)
B	Solenoid Ground (-)
	RSO 9
A	Solenoid Power (+)
B	Solenoid Ground (-)
	RSO 10
A	Solenoid Power (+)
B	Solenoid Ground (-)
	RSO 11
A	Solenoid Power (+)
B	Solenoid Ground (-)
	RSO 12
A	Solenoid Power (+)
B	Solenoid Ground (-)

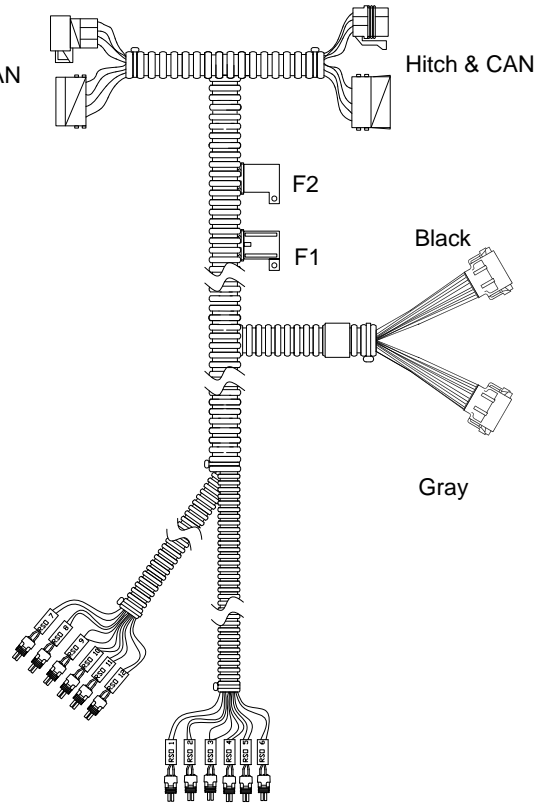

Pin	F1 Fuse Holder
	Solenoid Power
	15 Amp Fuse

Pin	F2 Fuse Holder
	ECU Power
	5 Amp Fuse

Pin	Function BLACK
1	RSO 11 (-)
2	RSO 9 (-)
3	CAN High
4	
5	
6	ECU Power
7	ECU Ground
8	
9	
10	CAN Low
11	RSO 10 (-)
12	RSO 12 (-)

Pin	Function GRAY
1	RSO 8 (-)
2	RSO 6 (+)
3	RSO 5 (+)
4	RSO 7 (-)
5	Solenoid Power
6	Solenoid Ground
7	Solenoid Ground
8	Solenoid Power
9	RSO 3 (-)
10	RSO 1 (+)
11	RSO 2 (+)
12	RSO 4 (-)

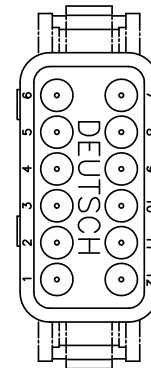

WIRE SIDE VIEW

IntelliAg® WSMT2

3-Wire Boom Control Harness P/N 467983100

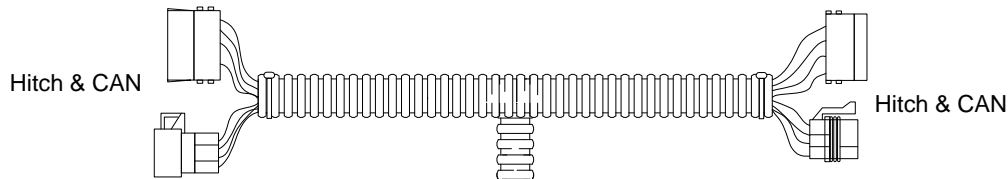

Pin	Function CONN H GRAY
1	
2	
3	
4	
5	Solenoid Power
6	Solenoid Ground
7	Solenoid Ground
8	Solenoid Power
9	
10	OutPut 5
11	OutPut 6
12	

Pin	Function CONN I BLACK
1	OutPut 3
2	OutPut 1
3	CAN High
4	
5	
6	ECU Power
7	ECU Ground
8	
9	Ground Boom ID
10	CAN Low
11	OutPut 2
12	OutPut 4

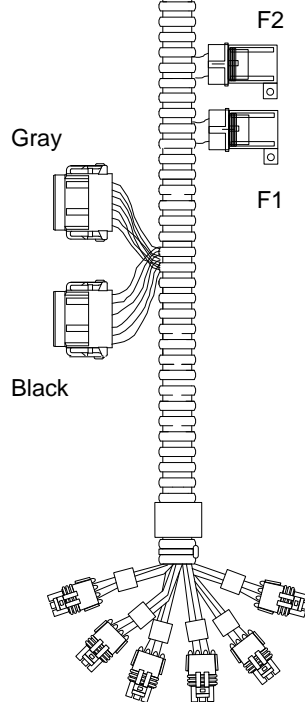

CONNECTION
E F G J K L

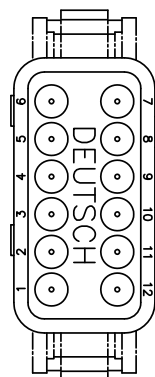

WIRE SIDE VIEW

Pin	F2 Fuse Holder
	ECU Power
	15 Amp Fuse

Pin	F1 Fuse Holder
	Solenoid Power
	15 Amp Fuse

Pin	Function
	CONN E
A	Solenoid Power (+)
B	Solenoid Ground (-)
C	OutPut 1
	CONN F
A	Solenoid Power (+)
B	Solenoid Ground (-)
C	OutPut 2
	CONN G
A	Solenoid Power (+)
B	Solenoid Ground (-)
C	OutPut 3
	CONN J
A	Solenoid Power (+)
B	Solenoid Ground (-)
C	OutPut 4
	CONN K
A	Solenoid Power (+)
B	Solenoid Ground (-)
C	OutPut 5
	CONN L
A	Solenoid Power (+)
B	Solenoid Ground (-)
C	OutPut 6

IntelliAg® WSMT2

2-Wire Boom Control Harness
P/N 467983101

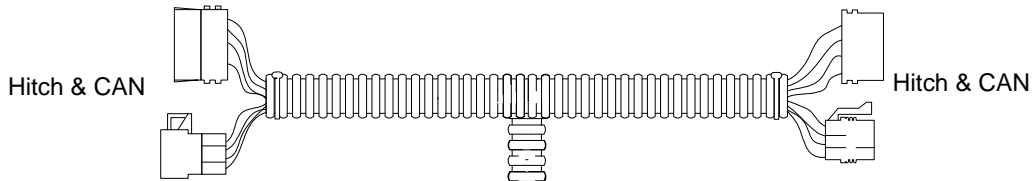

Pin	Function
	CONN E
A	Solenoid Power (+)
B	Solenoid Ground (-)
C	OutPut 1
D	OutPut 2
	CONN F
A	Solenoid Power (+)
B	Solenoid Ground (-)
C	OutPut 3
D	OutPut 4
	CONN G
A	Solenoid Power (+)
B	Solenoid Ground (-)
C	OutPut 5
D	OutPut 6

Pin	F2 Fuse Holder
	ECU Power
	15 Amp Fuse

Pin	F1 Fuse Holder
	Solenoid Power
	15 Amp Fuse

Pin	Function CONN H GRAY
1	
2	
3	
4	
5	Solenoid Power
6	Solenoid Ground
7	Solenoid Ground
8	Solenoid Power
9	
10	Boom 5
11	Boom 6
12	

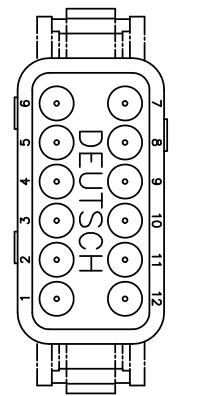

WIRE SIDE VIEW

Pin	Function CONN I BLACK
1	Boom 3
2	Boom 1
3	CAN High
4	
5	
6	ECU Power
7	ECU Ground
8	
9	Ground Boom ID
10	CAN Low
11	Boom 2
12	Boom 4

IntelliAg® WSMT2

2-Wire High Current Row Control Harness P/N 467983501

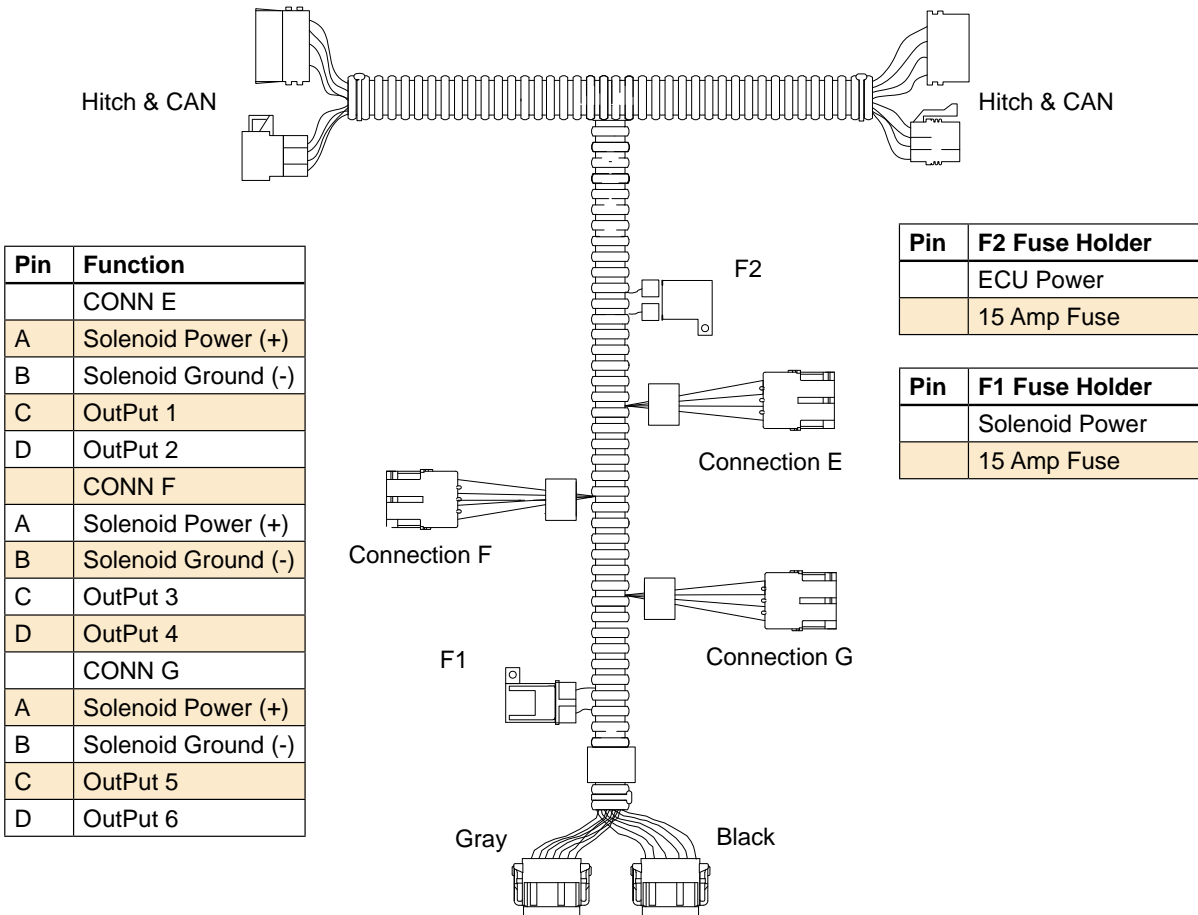

Pin	Function CONN H GRAY
1	
2	
3	
4	
5	Solenoid Power
6	Solenoid Ground
7	Solenoid Ground
8	Solenoid Power
9	
10	Row 5
11	Row 6
12	

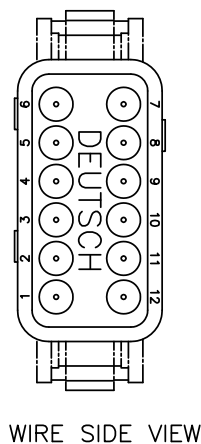

Pin	Function CONN I BLACK
1	Row 3
2	Row 1
3	CAN High
4	Ground Clutch ID
5	
6	ECU Power (+12V)
7	ECU Ground
8	
9	
10	CAN Low
11	Row 2
12	Row 4

IntelliAg® WSMT2

TruCount Air Clutch Row Control Harness P/N
467983505

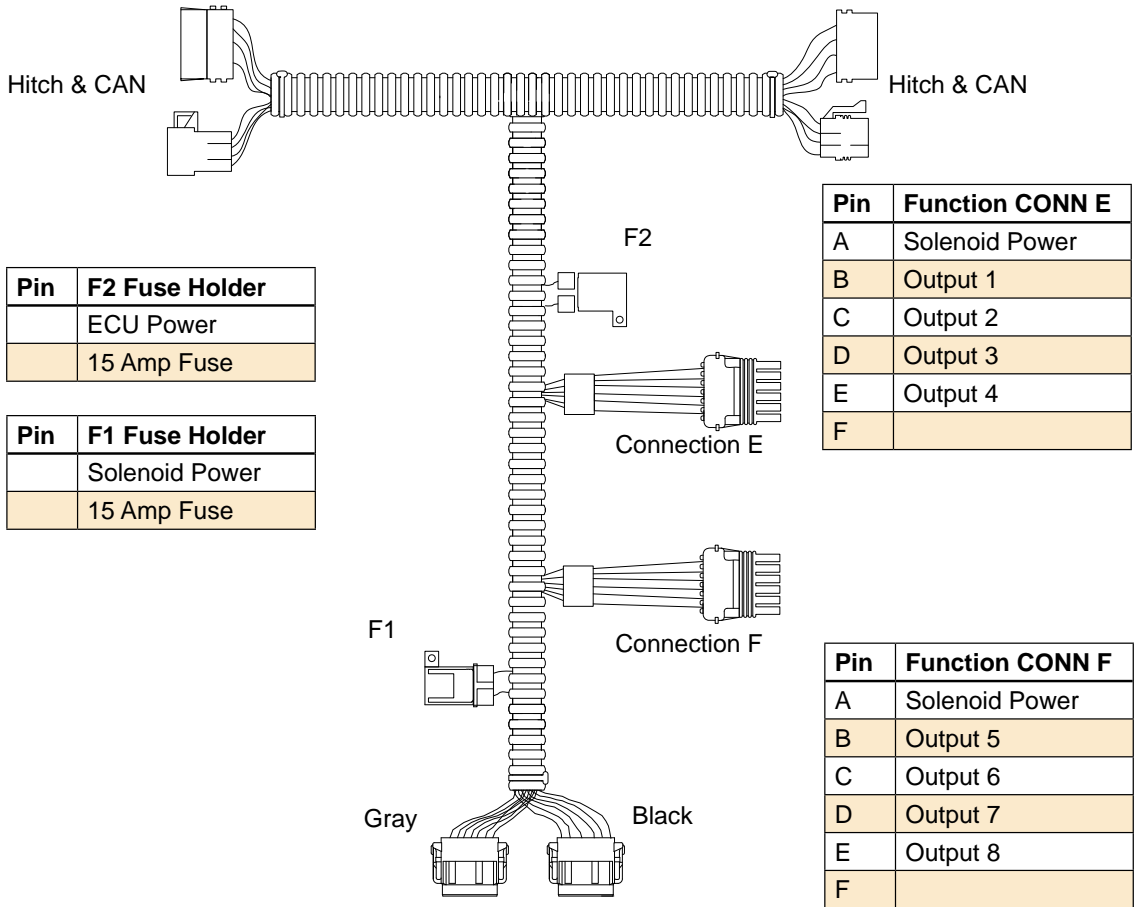

Pin	Function CONN H GRAY
1	
2	Output 8
3	Output 7
4	
5	Solenoid Power
6	Solenoid Ground
7	Solenoid Ground
8	Solenoid Power
9	
10	Output 5
11	Output 6
12	

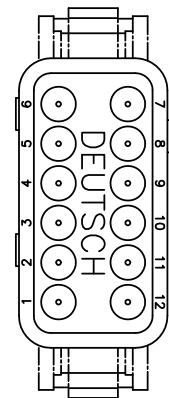

Pin	Function CONN I BLACK
1	Output 3
2	Output 1
3	CAN High
4	Ground Tru ID
5	
6	ECU Power (+12V)
7	ECU Ground
8	
9	Ground Boom ID
10	CAN Low
11	Output 2
12	Output 4

IntelliAg® WSMT2

2-Wire High Current Row Control Harness P/N 467983508

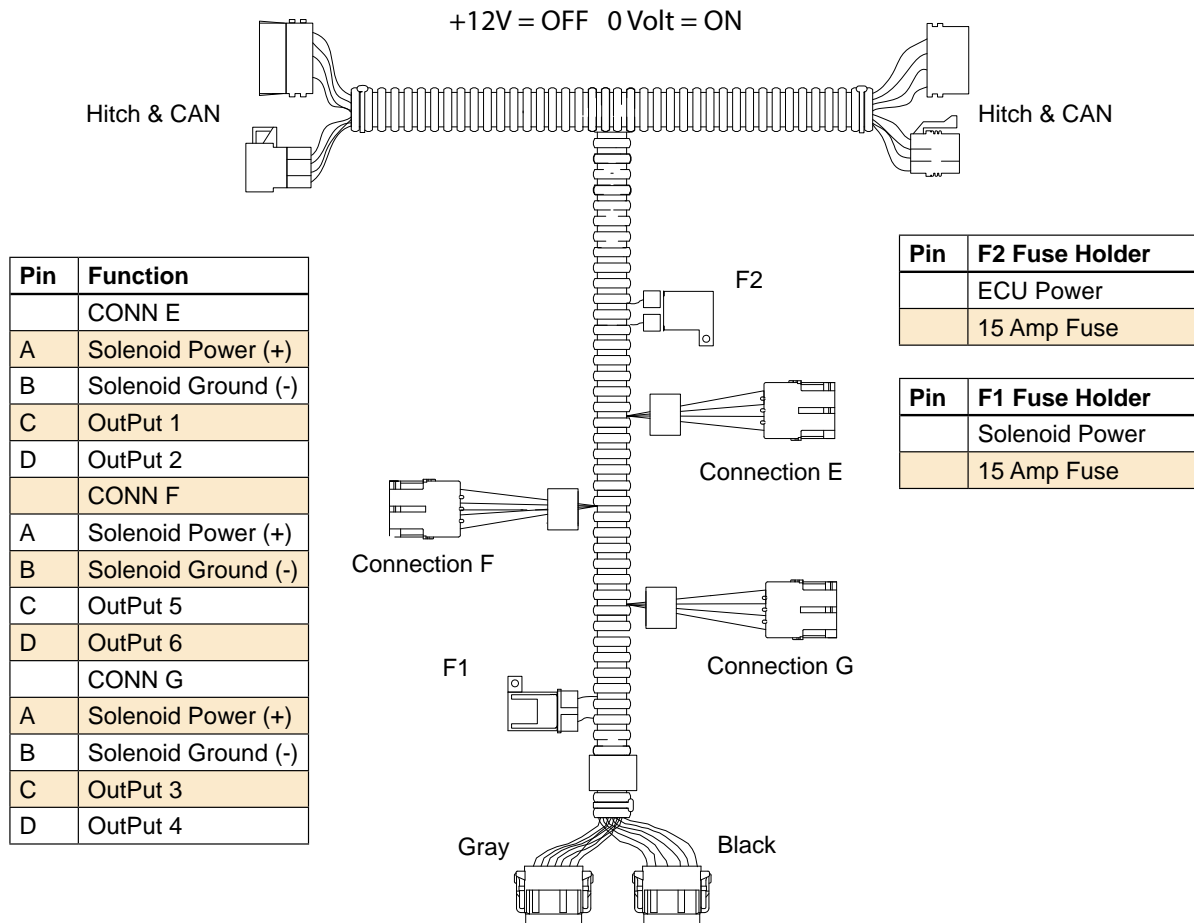

Pin	Function CONN H GRAY
1	
2	
3	
4	
5	Solenoid Power
6	Solenoid Ground
7	Solenoid Ground
8	Solenoid Power
9	
10	Row 5
11	Row 6
12	

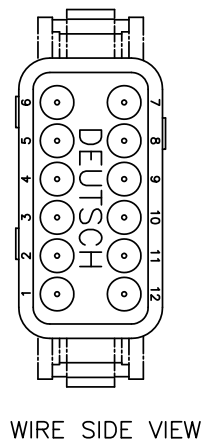

Pin	Function CONN I BLACK
1	Row 3
2	Row 1
3	CAN High
4	Ground Clutch ID
5	
6	ECU Power (+12V)
7	ECU Ground
8	
9	Aux 4in
10	CAN Low
11	Row 2
12	Row 4

Air Pressure



Air Pressure Sensor

- Measures air pressure in seed hopper
- 8 Volts DC

Connector Pin Numbers		
Pin No.	Color	Function/Voltage
A	Red	+8V
A	Black	Ground (0V)
A	Green	Signal

Air Pressure	
Part Number	Description
46682-092051	Air Pressure Sensor
46682-092251	Air Pressure Sensor with 1/2 in. Bushing



Hall-Effect Sensor

- Measures rotational shaft speed and ground speed
- Available in threaded or smooth surfaces for convenient mounting
- 12 volt sensor with square-wave signal output
- Detects teeth of sprocket, magnets, lug nuts, etc.

Connector Pin Numbers		
Pin No.	Color	Function/Voltage
A	Red	+12V
B	Black	Ground (0V)
C	Green	Signal (Sq. Wave)

Hall Effect	
Part Number	Description
46350-003051	Hall-Effect Sensor (smooth)
46697-001451	Hall-Effect Sensor (threaded)
46350-0120	Hall-Effect Sensor to Radar Extension 15.5 ft.
20040-0089	Jam Nut for threaded Hall-Effect Sensor (2 per sensor)
45968-0922	Hall-Effect Extension Cable 15 ft.
45910-0190	Magnet Kit

Hall-Effect

Hopper Level



Hopper Level Sensor

- Mounts inside planter, drill, or air cart
- Alerts when seed or granular material reaches low level
- 8 Volts DC

WP Connector Pin Numbers ID		
Pin No.	Color	Function/Voltage
A	Red	+8V
B	Black	Ground
C	Green	Signal (0V/12V)
D	N.C.	

Part Number	Description	Connector	Voltage
46682-0720S3	Hopper Level Sensor (Intelliag, PM)	WP, Individual(3)	8V
46682-0721S1	Hopper Level Sensor (Intelliag, PM) w/ 1/2 in Bushing	WP, Individual(3)	8V
46421-2001S1	Hopper Level Sensor 18" Cable	WP, 4 Pin Square	12V
46421-0870S1	Hopper Level Sensor 36" Cable (ICS2000)	WP, 4 Pin Square	12V
46421-0518S1	Hopper Level Sensor w/mounting plate (ICS2000)	WP, 4 Pin Square	12V
46421-2012S1	Hopper Level Sensor (Raven Only)	WP, 4 Pin Square	12V
46436-0550S1	Hopper Level Sensor (Land Manager)	WP, 3 Pin Flat	12V

Part Number	Description	Connector
46682-0713	5' HOPPER LEVEL HARNESS EXT.	WP, Individual(3)
46682-0712S1	10' HOPPER LEVEL HARNESS EXT.	WP, Individual(3)
46682-0714	15' HOPPER LEVEL HARNESS EXT.	WP, Individual(3)
46682-0710S3	20' HOPPER LEVEL HARNESS EXT.	WP, Individual(3)

Application Rate



Application Rate Sensor



Couplers

See Test Equipment section for an Application Rate Sensor Tester.

- Measures shaft rotation speed
- Outputs at 360 pulses per revolution for increased accuracy
- RPM range 2 - 2,500
- Easily adapts to 1 and 1 1/4 in. diameter shafts
- 12 volt sensor with square-wave signal output

Application Rate	
Part Number	Description
46436-0178S1	Application Rate Sensor, 1 ft. Cable (360 pulse per rev)
46436-1500S1	Application Rate Sensor, 1.5 ft. Cable (180 pulse per rev)
46436-0176S1	Application Rate Sensor, 5 ft. Cable (360 pulse per rev)
46436-0170S1	Application Rate Sensor, 10 ft. Cable (360 pulse per rev)
46436-0171S1	Application Rate Sensor, 15 ft. Cable (360 pulse per rev)
46436-0177S1	Application Rate Sensor, 22 ft. Cable (360 pulse per rev)
46436-0172S1	Application Rate Sensor, 30 ft. Cable (360 pulse per rev)
46436-1510S1	Application Rate Sensor, 30 ft. Cable (180 pulse per rev) Conxall connector
45714-1810	Application Rate Sensor Mounting Hardware (includes 1 in. Coupler)
45714-1850	Application Rate Sensor Mounting Hardware (includes 1 1/4 in. Coupler)
21016-0009	Shaft Coupler 1 in.
46421-1210S1	White Motor Sensor Adapter Cable
45790-1810	Application Rate Sensor Extension Harness, 15 ft.
45790-1811	Application Rate Sensor Extension Harness, 30 ft.
45790-1812	Application Rate Sensor Extension Harness, 45 ft.
46709-2218	Application Rate Sensor to HD4180 Mounting Kit

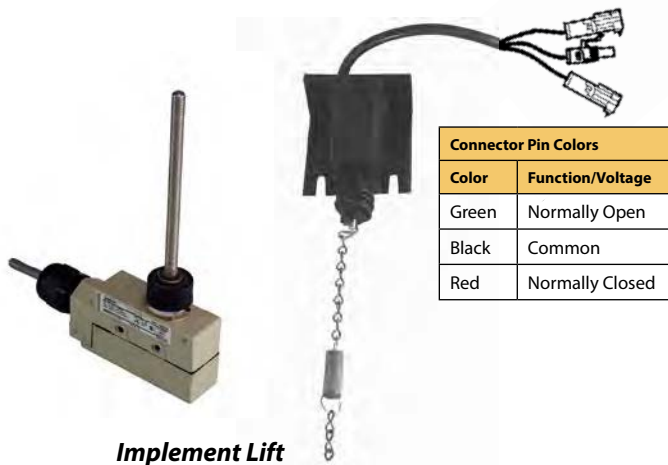

Implement Lift

Connector Pin Colors	
Color	Function/Voltage
Green	Normally Open
Black	Common
Red	Normally Closed

Implement Lift

- Enables or disables implement function
- Attaches to three-point hitch or lift cylinder
- Ties to planter monitors and control systems

Part Number	Description
46372-0150S1	Lift Switch with Weather-Pack Connector
45632-1070	Lift Switch with Mate-N-Loc Connector
10842-0001	Lift Switch Extension 30 ft.
46482-0520S1	Lift Switch Whisker Type

Gate Height



Gate Height

- Measures gate height setting in inches
- Automatically adjusts conveyor speed to compensate for gate height changes and maintain application rate
- Accuracy ± 0.1 in. of actual gate setting
- Operates with battery supply voltage of +9 to +16 VDC
- Provides +0 to +5 VDC analog signal output
- Potentiometer with working range of 110 degrees of rotation
- Can be mounted on left or right side of gate
- Pre-assembled, stainless-steel hardware and powder-coated mild steel mounting brackets

Part Number	Description
46649-2370S1	Gate Height Sensor

Extension Cable for Hopper Level Sensor, Air Pressure Sensor, Implement Lift Switch



Extension Cable for Flow Meter, Application Rate Sensor, Liquid Pressure Sensor



Extension Cable

Part Number	Description
46682-0713	Extension Cable 5 ft. (Hopper, Air Pressure, Implement Lift)
46682-0712S1	Extension Cable 10 ft. (Hopper, Air Pressure, Implement Lift)
46682-0714	Extension Cable 15 ft. (Hopper, Air Pressure, Implement Lift)
46682-0710S3	Extension Cable 20 ft. (Hopper, Air Pressure, Implement Lift)
46682-0711S3	Extension Cable 40 ft. (Hopper, Air Pressure, Implement Lift)
45790-1810	Extension Cable 15 ft. (Flow Meter, App Rate, Liquid Pressure)
45790-1811	Extension Cable 30 ft. (Flow Meter, App Rate, Liquid Pressure)
45790-1812	Extension Cable 45 ft. (Flow Meter, App Rate, Liquid Pressure)

Liquid



2-way Stainless Steel Valve with 467095075 Actuator 3/8", 1/2"



2-way Stainless Steel Valve with 467095060 Actuator 1", 3/4", 2"



2-way Stainless Steel Valve with 467095250 Actuator 3"



2-way Poly Valve with 467095070 Actuator 3/4", 1"



2-way Stainless Steel Valve with 467084070 Actuator 1/4"

Two-way regulating control valves, stainless steel, available in 3/8 in., 1/2 in., 3/4 in., 1 in., 2 in., and 3 in.

Valve Parts			
Part Number	Valve Size (Inches)	CV Flow Rate GPM	Description
46709-5010	3/8	7.2	Stainless Steel Valve, 2-way with 46709-5075 Actuator
46709-5020	1/2	30	Stainless Steel Valve, 2-way with 46709-5075 Actuator
46709-5290	1	68	Stainless Steel Valve, 2-way with 46709-5060 Actuator
46709-5150	2	376	Stainless Steel Valve, 2-way with 46709-5060 Actuator
46709-5170	3	720	Stainless Steel Valve, 2-way with 46709-5250 Actuator
46709-5320	1/4	8.4	Stainless Steel Valve, 2-way with 46709-5070 Actuator

Two-way Poly regulating control valves available in 3/4 in., 1 in.

Valve Parts			
Part Number	Valve Size (Inches)	Flow Rate GPM	Description
46709-5030	3/4	51	Poly Valve, 2-way with 46709-5070 Actuator
46709-5280	1	68	Poly Valve, 2-way with 46709-5070 Actuator

Two-way regulating control valve, carbon steel, available in 1 in.

Valve Parts			
Part Number	Valve Size (Inches)	Flow Rate GPM	Description
46709-5040	1	43	Carbon Steel Valve, 2-way with 46709-5065 Actuator

Liquid Servo Valve Extensions

Part Number	Description
45790-1820	Extension Cable 15 ft. 6-pin WP
45790-1821	Extension Cable 30 ft. 6-pin WP



Liquid Servo Valve Extension



2-way Carbon Steel Valve with 467095060 Actuator 1"

Connector Pin Numbers ID		
Pin No.	Color	Function/Voltage
A	Red	+12V
B	Black	Ground (0V)
C	White	Open (0-12V)
D	Green	Close (0-12V)
E	Blue	APER (0-12V)
F	N.C.	

Liquid



**3-way Poly or Stainless Steel Valve with
467095370 Actuator 1 1/2"**

Three-way regulating control valve assemblies available in 1.5 in. and 2 in.

Valve Parts			
Part Number	Valve Size (Inches)	Flow Rate GPM	Description
46709-5050	1 1/2	47	Poly Valve, 3-way Poly with 46709-5370 Actuator
46709-5140	1 1/2	103	Stainless Steel Valve, 3-way with 46709-5370 Actuator
46709-5160	2	143	Stainless Steel Valve, 3-way with 46709-5250 Actuator



**3-way Stainless Steel Valve with
467095250 Actuator 2"**

Connector Pin Numbers ID		
Pin No.	Color	Function/Voltage
A	Red	+12V
B	Black	Ground (0V)
C	White	Open (0-12V)
D	Green	Close (0-12V)
E	Blue	APER (0-12V)
F	N.C.	

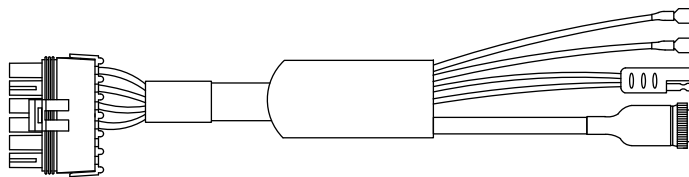

**Raven Fast Valve Adapter Harness
466980100**

Raven Fast Valve Adapter Harness

Adapter Harness	
Part Number	Description
46698-0100	Raven Fast Valve Harness Adapter
46698-0040S1	Raven Flow Meter Adapter Harness

Liquid Boom Shutoff

Liquid Boom Shutoff Valves (on/off)

Actuators Only		
Part Number	Used With	Description
46709-6030	46709-6000 46709-6010 46709-6020	Actuator Assembly EH5 On/Off 3/4"
46709-5260	46709-5130	Actuator Assembly Shutoff Valve 1"
46709-6060	46709-6040	Actuator Assembly EH22 3/4"



**Single Liquid Shutoff Valve
467096000 3/4"**



**3 Bank Shutoff Valve
467096010 3/4"**



**5 Bank Shutoff Valve
467096020 3/4"**



**Single Shutoff Valve
467096040 3/4"**



**Single Shutoff Valve
467095130 1"**

Liquid Shutoff Valves

Valve Assemblies			
Part Number	Valve Size (Inches)	Flow Rate GPM	Description
46709-6000	3/4	40	Single Shutoff Valve and Actuator
46709-6010	3/4	38	3 Bank Shutoff Valve and Actuator
46709-6020	3/4	38	5 Bank Shutoff Valve and Actuator

Boom Shutoff Valve Fittings		
Part Number	Hose Size (Inches)	Description
46709-7020	1/2	Boom Shutoff Valve Fitting, straight
46709-7030	1/2	Boom Shutoff Valve Fitting, 90 degree
46709-7040	3/4	Boom Shutoff Valve Fitting, straight
46709-7050	3/4	Boom Shutoff Valve Fitting, 90 degree
46709-7060	3/4	Boom Shutoff Valve Fitting, female NPT
46709-7070	1	Boom Shutoff Valve Fitting, straight
46709-7080	1	Boom Shutoff Valve Fitting, 90 degree
46709-7090	1	Boom Shutoff Valve Fitting, male NPT



467097020



467097030



467097040



467097050



467097060



467097070



467097080



467097090

Valve Body w/o Actuator

Valve body without actuator available in 3/8 in., 1/2 in., 3/4 in., 1 in., 1.5 in., 2 in., and 3 in.

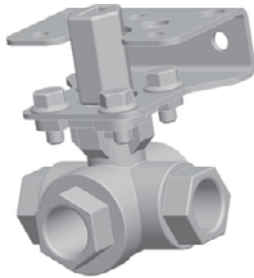

3-way Stainless Steel Valve 3/8"

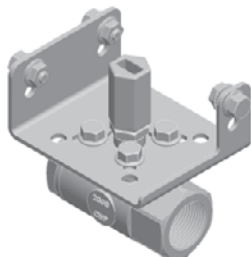

**2-way Stainless Steel Valve
3/8", 1/2", 3/4", 1"**



2-way Poly Valve 3/4", 1"

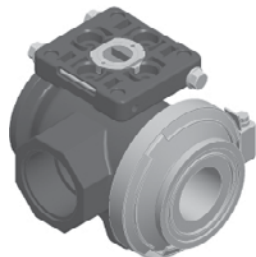

3-way Poly Valve 1.5"



2-way Carbon Steel 1"

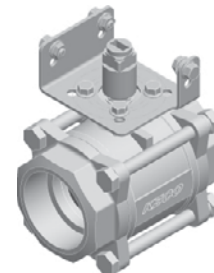

2-way Stainless Steel Valve 2", 3"

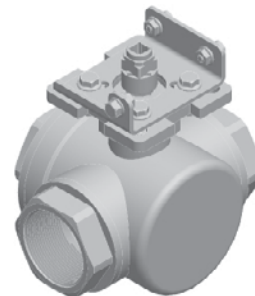

3-way Stainless Steel Valve 1.5", 2"

Ball Valve (NH3) 1.25"

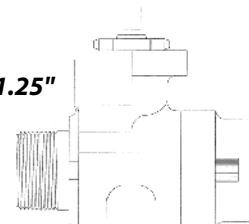

Valve Parts		
Part Number	Valve Size (Inches)	Description
46709-5080	3/8	Stainless Steel Valve, 2-way
46709-5230	3/8	Stainless Steel Valve, 3-way
46709-5090	1/2	Stainless Steel Valve, 2-way
46709-5310	3/4	Stainless Steel Valve, 2-way
46709-5100	3/4	Poly Valve, 2-way
46709-5110	1	Carbon Steel Valve, 2-way
46709-5180	1	Poly Valve, 2-way
46709-5120	1.5	Poly Valve, 3-way
46709-5190	1.5	Stainless Steel Valve, 3-way
46709-5200	2	Stainless Steel Valve, 2-way
46709-5210	2	Stainless Steel Valve, 3-way
46709-5240	3	Stainless Steel Valve, 2-way
45790-3380	1 1/4	Ball Valve (NH3)

Actuator Assemblies

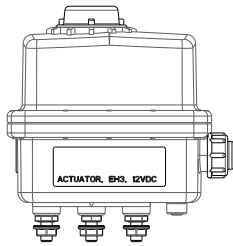

**Actuator Assembly
467095070**

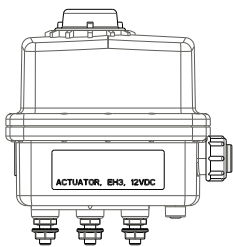

**Actuator Assembly
467095075**



**Actuator Assembly
467095060**

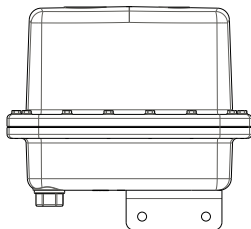

**Actuator Assembly
467095250**



**Actuator Assembly (Shutoff Valve)
467095260**

Actuators		
Part Number	Used With Valve	Description
46709-5060	46709-5110 46709-5120 46709-5190 46709-5200	Actuator Assembly EH2 (used with Continental 1.25 in. NH3 Valve p/n 45790-3380)
46709-5070	46709-5100 46709-5180 46709-5330	Actuator Assembly EH3
46709-5075	46709-5080 46709-5230 46709-5090	Actuator Assembly EH3
46709-5250	46709-5210 46709-5240	Actuator Assembly EH5
46709-5260	46709-6000 46709-6010 46709-6020	Actuator Assembly EH5 On/Off
46709-6030	46709-5130	Actuator Assembly Shutoff Valve
46709-5065	46709-5110 46709-5310	Actuator Assembly EH22
46709-5370	46709-5120 46709-5190	Actuator EH2

Adapter Bracket and Coupler (for use with Continental 1.25 in. NH3 Valve)	
Part Number	Description
46709-7000	EH2 Actuator to Continental NH3 Valve Bracket (used to mount EH2 actuator on 1.25 in. Valve)
46709-7010	EH2 Actuator to Continental NH3 Valve Coupler (used to mount EH2 actuator on 1.25 in. Valve)
45790-4000	Adapter Bracket and Coupler Kit (includes 46709-7000 and 46709-7010)

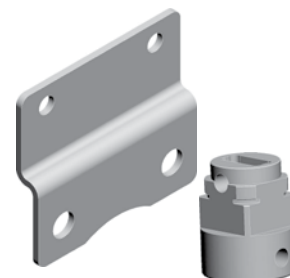

Adapter Bracket and Coupler

Proportional Hydraulic Flow

Dual Flow



Use with 46421-0430S1
 PWM Granular Valve
 Drive Module

Dual Flow



The Dual Flow Spreader Control Valve provides proportional control of the spinner and conveyor/auger motor and can be mounted outside the cab. The valve is a direct replacement for the Fluid Control 2FLL1 2 or equivalent spreader valve and can operate with either a fixed displacement or variable displacement (load sense) pump. Can also run continuously with the spinner circuit shutoff.

SPECIFICATIONS:

- **Operating Pressure:** Inlet 4,000 psi
- **Regulated Flow Rate:** 0-17 GPM or 0-34 GPM auger/conveyor
0-10 GPM Spinner
- **Internal Leakage:** 50 cc/min. max at 2,000 psi
- **Coil Voltage:** 12 VDC
- **Max Control Current:** 1,400 ± 100 mA

Part Number	Description
46709-2100	Dual Hydraulic Valve (HydraForce) 17 GPM conveyor/10 GPM spinner, fixed displacement
46709-2101	Dual Hydraulic Valve (HydraForce) 17 GPM conveyor/10 GPM spinner, load sense
46709-2110	Dual Hydraulic Valve (HydraForce) 34 GPM conveyor/10 GPM spinner, fixed displacement
46709-2111	Dual Hydraulic Valve with load sense (HydraForce) 34 GPM conveyor/10 GPM spinner
46709-0421	Replacement Cartridge
46709-0360	Replacement Coil

P4 & P8

P4 and P8 Proportional Flow Control Valves are electrical-variable two-way, pressure-compensated spool valves and can be used with either open or closed-center hydraulics by plugging port 2 of the valve body.

SPECIFICATIONS:

- **Operating Pressure:** Inlet 3,500 psi (240 bar)
- **Regulated Flow Rate:** 0-4 GPM (0-15 LPM) p/n 46709-2004S1
0-8 GPM (0-30 LPM) p/n 46709-2008S1
- **Reverse Free Flow**
Cracking Pressure: 15-20 psi (1-1.4 bar)
- **Internal Leakage:** 0.10 GPM (0.38 LPM) at zero current
- **Coil Voltage:** 12 VDC
- **Max Control Current:** 1,500 ± 100 mA
- **Solenoid operated**
- **Normally closed when d-energized**
- **Three port**



P4, P8, and P24

- Port 1** Supply/In
- Port 2** Bypass (Tank)
- Port 3** Regulated

Part Number	Description
46709-2050S1	Valve Assembly 24 GPM
46709-2004S1	P4 Valve Assembly 4 GPM
46709-2008	P8 Valve Assembly 8 GPM
46709-0360	Replacement Coil 4 or 8 GPM Valve
46709-0380	Replacement Cartridge 4 GPM
46709-0370	Replacement Cartridge 8 GPM

HD 4180™



HD 4180™ is a combination hydraulic motor and proportional hydraulic valve used in conjunction with a ground speed control system. It is used on planters and air seeders to rotate the seeding shafts instead of using ground-driven gear boxes. Utilizing hydraulic and ground speed systems allow for manual or variable rate adjustments to the seeding population per acre while moving through the field.

Features:

- 0 - 4 GPM hydraulic flow delivers 4 - 180 RPM at 1,400 inch pounds of torque
- Eliminates ground-drive systems to rotate seeding shafts
- Install up to four units in series to control multiple planter sections or fertilizer application
- Interface with a ground speed control system for variable rate control of planter and fertilizer application in the field
- Manual override of hydraulic flow in the event of electrical failure

HD 4180™	
Part Number	Description
46709-2200S1	HD4180 HydraDrive
46709-2219S1	HD4180 Mounting Bracket with Hardware
46709-2218	HD4180 ARS Mounting Hardware Kit only
46709-2219	Mounting Bracket only
46709-2221	ARS to Motor Coupler only
46798-0470	Extension Cable 15 ft.
46798-0471	Extension Cable 20 ft.
46798-0473	Extension Cable 30 ft.
46798-0472	Extension Cable 40 ft.
46709-0360	Replacement Coil
46709-0380	Replacement Cartridge
46709-2200	Replacement Motor
46709-2219S1	Mounting Bracket with Hardware includes:
46709-2214	* 18 tooth HydraDrive Motor Sprocket
46709-2215	* HydraDrive 14 Tooth Idler Sprocket
46709-2216	* HydraDrive Spacer
46709-2217	* 7x7 Square U-Bolt
46709-2218	* ARS Hardware Kit for 467092219S1
46709-2219	* Mounting Bracket for 467982200 (Planters)

CALCULATING FLOW RATE REQUIREMENTS

Granular Spreading/Drill and Air Seeders

(Hydraulic Oil Flow)

To calculate the hydraulic oil flow requirements to select the optimal hydraulic control valve used with a hydraulic motor, use the below formula:

Hydraulic Oil Flow Rate Formula (assumes 1:1 gear ratio): **(Hydraulic motor in3/rev x Motor RPM required divided by 231)**

IN3/REV Motor Spec	Max Motor RPM Required for Application	Constant IN3 in 1 Gallon	Oil GPM Required
41.2	120	/231	21

(Hydraulic Motor RPM)

To calculate the motor RPM required to achieve maximum application rate, enter value for pounds per 1 revolution, maximum application rate, ground speed, and spread width (assumes 1:1 gear ratio).

Pounds discharged from Vbox spreader per 1 Rev. of the conveyor belt drive shaft	Max. Application Rate (lbs/acre)	Ground Speed (MPH)	Spread Width in Feet	Max. Motor RPM Required for Application (B / A)
10	1200	10	40	97

CONSTANT VALUES USED IN FORMULA (DO NOT CHANGE)

Square Feet in 1 Acre 43560
 1 Mile 5280
 Distance (feet) traveled per minute at ground speed stated in table above $880 = (\text{MPH} \times 5280) / 60$
 A - Time required to apply material on 1 acre at ground speed stated in table above $1.2375 = 43560 / (\text{dist travel} \times \text{spread width})$
 B - Conveyor shaft revolutions required to apply maximum application rate $120 = \text{max. application rate} / \text{pounds discharged}$

Row Crop Planter

(Hydraulic Oil Flow)

To calculate the hydraulic oil flow requirements to select the optimal hydraulic control valve for use with a hydraulic motor, use the below formula:

Hydraulic Oil Flow Rate Formula (assumes 1:1 gear ratio): **(Hydraulic motor in3/rev x Motor RPM required divided by 231)**

IN3/REV Motor Spec	Max Motor RPM Required for Application	Constant IN3 in 1 Gallon	Oil GPM Required
5	82	231	1.8

(Hydraulic Motor RPM)

To calculate the motor RPM required to achieve maximum application rate, enter values for seeds dropped per 1 rev. of planter row unit, max. application rate, ground speed, and row spacing.

Seeds dropped per 1 Rev. of the planter row unit (seeds)	Max. Seeding Rate (seeds/acre)	Ground Speed (MPH)	Spread Width in Feet	Max. Motor RPM Required for Application (B / A)
60	120,000	8	3	97

CONSTANT VALUES USED IN FORMULA (DO NOT CHANGE)

Square Feet in 1 Acre 43560
 1 Mile 5280
 Distance (feet) traveled per minute at ground speed stated in table above $704 = (\text{MPH} \times 5280) / 60$
 A - Time required to apply material on 1 acre at ground speed stated in table above $20.625 = 43560 / (\text{dist travel} \times \text{spread width})$
 B - Planter shaft revolutions required to apply maximum application rate $2000 = \text{max. seed rate} / \text{seeds dropped per rev.}$

Hydraulic Servo Valve

Servo Hydraulic Flow Control Valves are used for precise oil flow to hydraulic-driven conveyors and liquid pumps.

Features:

- Close to open in 1.5 seconds
- Environmentally sealed
- Drives 3/8 to 1 in. liquid



The system must be in operation to make adjustments. Both adjustments are located under the center plate.

CAUTION: Be cautious to not overspeed the hydraulic motor.

Adjustment 1 (To eliminate creep)

1. Loosen the Allen head screw (large) in the coupling collar.
2. Using pliers, rotate the valve stem until creep stops to establish a closed position.
3. Re-tighten the collar.

Adjustment 2 (Adjust maximum flow rate GPM)

1. Loosen the small Allen head screw in the orifice adjustment collar.
2. Using pliers, turn the orifice adjustment collar counterclockwise to increase flow; clockwise to decrease flow.
3. Re-tighten orifice collar screw.

This actuator does not require the hydraulic valve driver as on older style actuators.

Part Number	Description
15557-0001	Servo Valve 30 GPM 20 ft. cable 6-pin Weather Pack
15557-0004	Servo Valve 18 GPM 20 ft. cable 6-pin Weather Pack
15557-0011	Servo Valve 13 GPM 20 ft. cable 6-pin Weather Pack
15557-0013	Servo Valve 16 GPM 20 ft. cable 6-pin Weather Pack
15557-0015	Servo Valve 25 GPM 20 ft. cable 6-pin Weather Pack
15557-0016	Servo Valve 20 GPM 20 ft. cable 6-pin Weather Pack
15557-0021	Servo Valve 11 GPM 20 ft. cable 6-pin Weather Pack
15557-0022	Servo Valve 58 GPM 20 ft. cable 6-pin Weather Pack
15557-0023	Servo Valve 18 GPM (Ag Chem) 3-pin Metri Pack
15557-0024	Servo Valve 13 GPM (Ag Chem) 3-pin Metri Pack
15557-0025	Servo Valve 30 GPM (Ag Chem) 3-pin Metri Pack
15557-0026	Servo Valve 58 GPM (Ag Chem) 3-pin Metri Pack
46709-5360	Actuator only used on 15557-0001 to -0022. Requires hardware kit 46709-8040.
46709-8040	Hardware Mounting Kit
46709-5350	Actuator only used on 15557-0023 to -0026. Requires hardware kit 46709-8040.

Actuator			Harness
Connector Pin	Pin Numbers	ID	Color
A	Red	+12V	Red
B	Black	Ground	Black
C	White	Signal to open	Brown
D	Green	Signal to close	White
E	Blue	Feedback at open	Gray
F	N.C.		N.C.

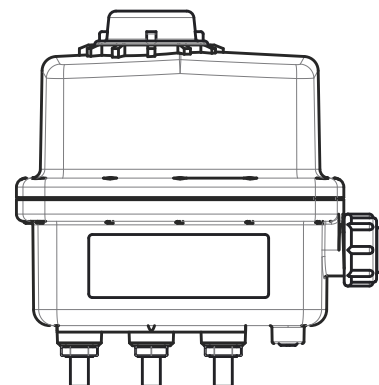

Actuator 46709-5350

Hydraulic Valve Driver Module



Hydraulic Valve Driver 46436-0030A

Servo Hydraulic Flow Control Valves are used for precise oil flow to hydraulic-driven conveyors and liquid pumps.

Features:

- Close to open in 1.5 seconds
- Environmentally sealed

Hydraulic Servo Flow Control	
Part Number	Description
46436-0030A	Hydraulic Servo Valve Driver
43940-0026	Hydraulic Valve Extension 10 ft.
46421-0431S1	PWM Hydraulic Valve Driver

6-pin WP Connector Pin Numbers ID		
Pin No.	Color	Function/ Voltage
A	Red	+12V
B	Black	Ground (0V)
C	Brown	Open (0-12V)
D	White	Close (0-12V)
E	Gray	APER (0-12V)
F	N.C.	

Amp CPC Connector Pin Numbers ID		
Pin No.	Color	Function/ Voltage
1	Yellow	Signal (0-12V) Close
2	N.C.	
3	Orange	Signal (0-12V) Open
4	Gray	APER Alarm



PWM Hydraulic Valve Driver 46421-0431S1



Linear Valve Driver 46490-0010S1

6-pin WP Connector Pin (2 Sets) Numbers ID		
Pin No.	Color	Function/ Voltage
Channel 1 Connector		
A	Red	+12V
B	Black	Ground
C	White	ACTR1 (PWM)
Channel 2 Connector		
D	Brown	ACTR2 (PWM)
E		
F	N.C.	

2-pin WP Connector Pin (2 Sets) Numbers ID		
Pin No.	Color	Function/ Voltage
A	White	ACTR1/ACTR2 (PWM) BN
B	Gray	Ground
A	Brown	ACTR2
B	Black	Ground

6-pin WP Connector Pin Numbers ID		
Pin No.	Color	Function/ Voltage
B	Black	Ground
C	Brown	ACTR1 (PWM)
D	N.C.	
E	N.C.	
F	N.C.	

Amp CPC Connector Pin Numbers ID		
Pin No.	Color	Function/ Voltage
1	Green	Signal (0-12V)
2	Black	Ground
3	N.C.	

Daisy Chain Blockage Detection System



Daisy Chain Sensor

The Daisy Chain blockage detection system monitors seed and fertilizer flow on air seeder applications to determine if distribution hoses are open or blocked. Sensors are connected to each other in a serial chain layout contained within the loop.

The system is designed with redundant communication between sensors so that any defective sensor within the system does not shutdown the entire blockage system. Blockage full screen alarms quickly pinpoint exact sensor blockage, communication, or wiring issues to remove guesswork from troubleshooting.

One module can connect to 1 or 2 loops. A maximum of 4 modules and 8 loops connect to sensors that communicate blockage and system status for display on the virtual terminal.

The blockage system is compatible with any ISO virtual terminal including DICKEY-john®, Case, John Deere, and AGCO terminals.



Daisy Chain Module

Features:

- Monitors up to 4 modules and a total of 8 loops
- Each module can interface with a maximum of 2 sensor loops
- Maximum number of sensors per loop is 54 for a total of 432 sensors
- Tramline monitoring of seed or fertilizer with up to 192 sensors assigned to tramlining
- Full screen alarms pinpoint blockage or system issues for quick resolution
- Bi-directional communication lines between sensors and modules
- System can continue to monitor sensor blockage with 1 line failure
- Three system tests (communication, power, and sensor) provide immediate feedback of system status)
- Additional rows and blockage sensors can be added later with minimal harnessing changes

Daisy Chain Blockage Detection System	
Part Number	Description
46798-8670S1	Sensor 32mm
46798-8840S1	Sensor 50 mm
46798-8865S1	Sensor 45 mm
46798-8885S1	Sensor 25mm
46798-8690S1	Sensor Module

Daisy Chain Blockage Detection System



DCBS IntelliAg® Adapter



Module Harness ISO 1 Loop



Module Harness ISO 2 Loop



Module Extension Harness 6m or 10m



CAN Bus Adapter Harness

46798-8752 Fly Leads

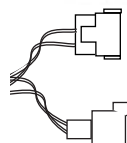

46798-8751 Packard connectors

Daisy Chain Blockage Detection System	
Part Number	Description
46798-8749	DCBS IntelliAg Adapter
46798-8720	Module Harness ISO 1 Loop
46798-8730	Module Harness ISO 2 Loop
46798-8741	Module Extension Harness 6 Meter
46798-8740	Module Extension Harness 10 Meter
46798-8761	Terminator
46798-8759	Lift Switch/Tramline Connector Kit (includes 1 Deutsch connector, 1 Deutsch wedge, 5 Deutsch terminals, and 10 Deutsch cavity plugs)
46798-8751	CAN Bus Adapter Harness with Packard connectors
46798-8752	CAN Bus Adapter Harness with fly wire leads
11001-1620B	Daisy Chain Operator's Manual



Terminator

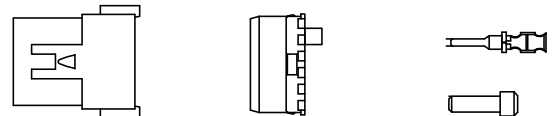

Lift Switch/Tramline Connector Kit

Lift Switch/Tramline Connector Kit Pinout	
1	12V Power
2	12V Accessory
3	Accessory Ground Out
4	Accessory Ground
5	Input 5
6	Input 7 Lift Switch
7	Input 3
8	Input 1
9	Ground Speed
10	Input 2
11	Input 4
12	Input 6

Typical Installation

Daisy Chain Blockage Detection System

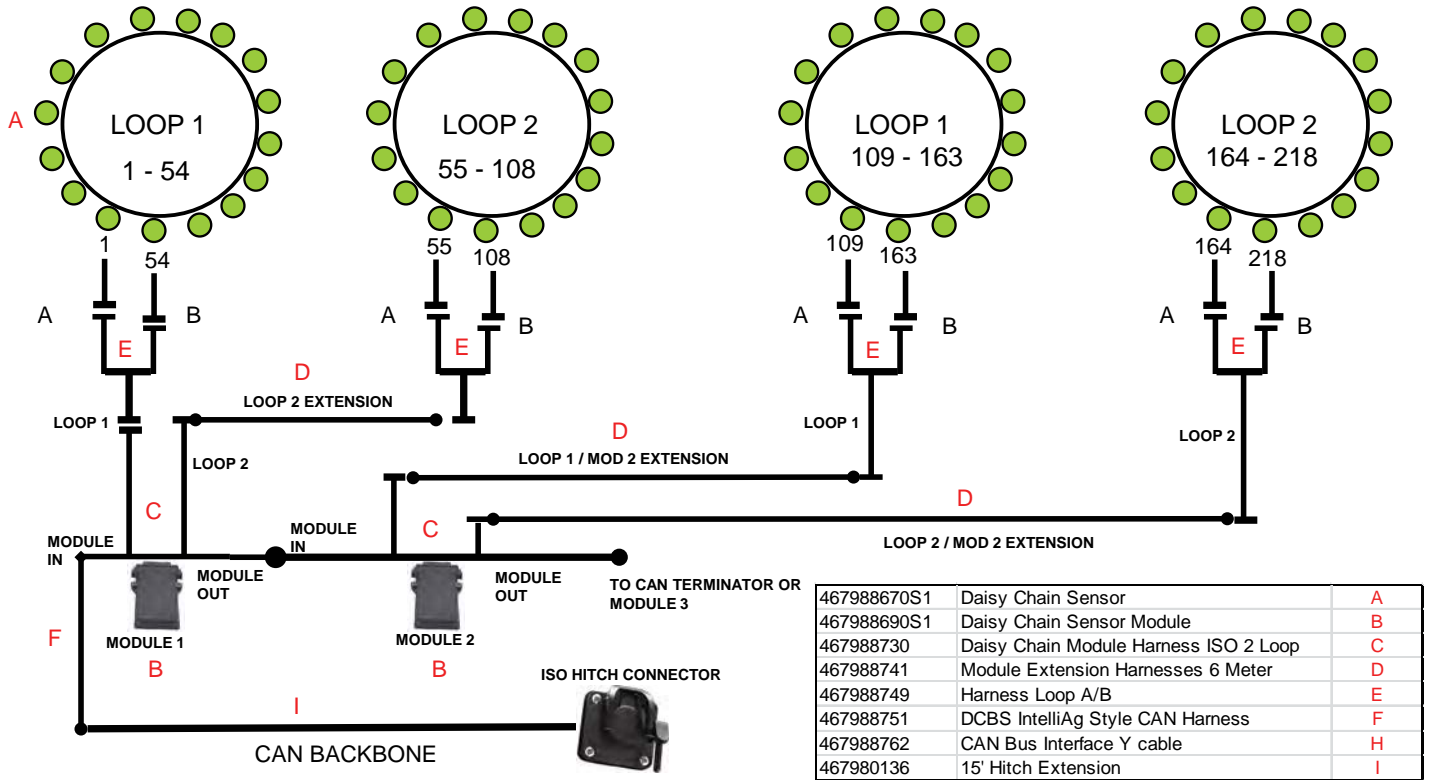

Alternate Installation

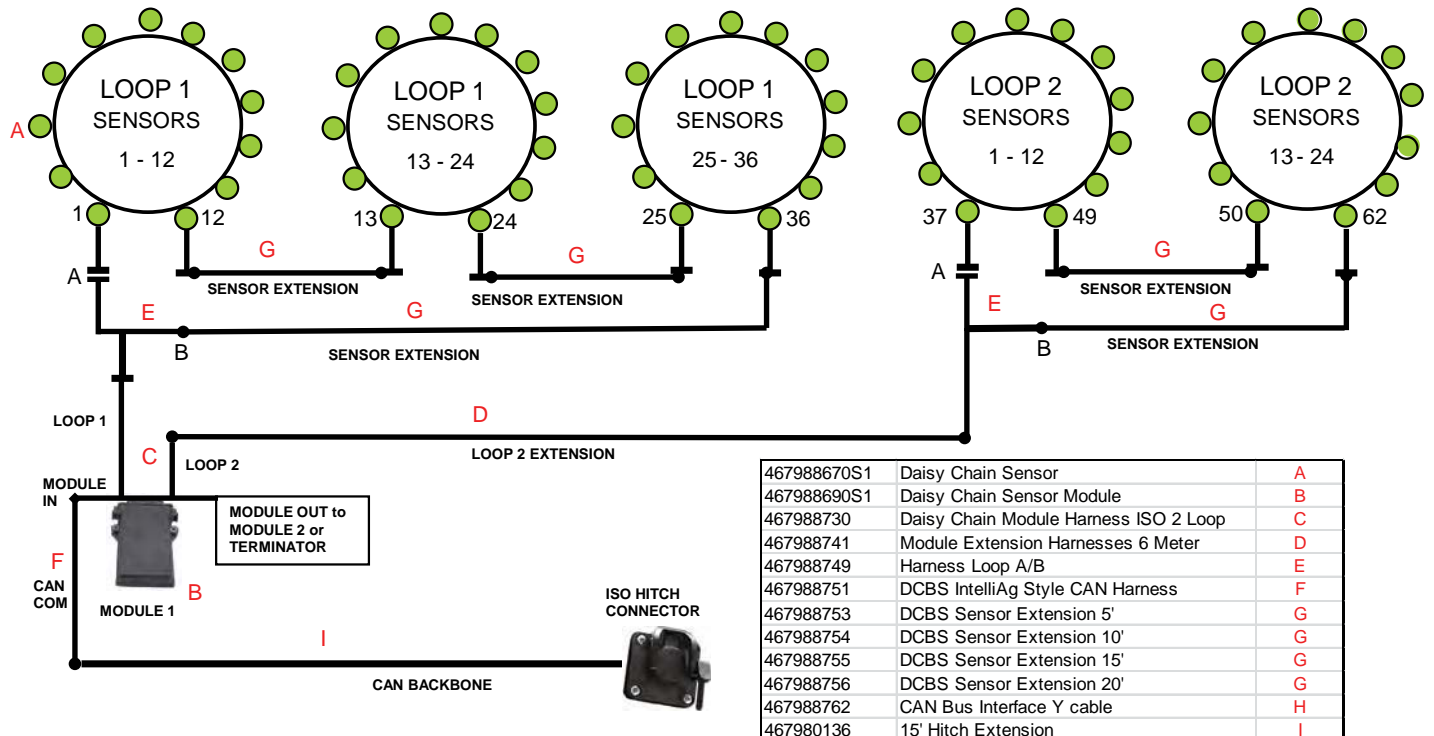

ASM™ II Air Seeder

The ASM™ II Air Seeder Monitor alerts when the seeding rate falls below a programmable seeds per second threshold. The system monitors blockage up to 128 rows or 120 rows and 8 Hopper Level Sensors.



ASM™ II

Features:

- Input from 16 sensors or 15 sensors and one Hopper Level Sensor
- Internal audible alarm
- LED dimming for day or night use
- Planting indicator
- Alarm recognition override
- Implement Lift Switch input
- Module and sensor self test



16 Row Module

Don't forget to select a:

- Seed Sensor
- Ground Speed Sensor
- Hopper Level Sensor
- Hall-Effect Sensor
- Flow Meter
- Implement Lift Switch

Part Number	Description
Console and Module	
46794-2002S1	Console and Harness
46794-2057S1	Input Module, 16 row
46794-2058S1	Hopper Input Module, 15 row
Module Harness	
46775-1300S1	Harness, 12 row, 7.5 in.
46775-1301S1	Harness, 12 row, 15 in.
46775-1302S1	Harness, 12 row, 30 in.
46775-1320S1	Tower Harness, 12 row
46775-1310S1	Harness, 16 row, 7.5 in.
46775-1311S1	Harness, 16 row, 15 in.
46775-1312S1	Harness, 16 row, 30 in.
46775-1330S1	Tower Harness, 16 row
485 Module Extensions	
46775-1200S1	485 Module Extension, 4 ft.
46775-1201S1	485 Module Extension, 6 ft.
46775-1202S1	485 Module Extension, 10 ft.
46775-1203S1	485 Module Extension, 15 ft.
46775-1204S1	485 Module Extension, 20 ft.
46775-1205S1	485 Module Extension, 25 ft.
46775-1206S1	485 Module Extension, 30 ft.
46775-1207S1	485 Module Extension, 40 ft.
46775-1208S1	485 Module Extension, 45 ft.
46775-1209S1	485 Module Extension, 50 ft.

NOTES:

- P1 modules address from end to middle; P2 modules address from middle to end.
- Lift Switch is optional.
- Power is not switched through the console due to worst case voltage drop on 128-row system.
- P2 is not required for systems with 4 modules or less (64 rows or less). P1 can drive 4 modules.

Air Drill/Box Drill/Fertilizer Sensors

Vigilense®

- Can replace existing sensors that sense material detection via a drilled hole or a flow-thru style
- Easy installation
- Detects all sizes of seeds, granular fertilizers, and pesticides
- Use with air seeders and grain drills
- Optical technology eliminates disturbance of seed flow
- Choose either a standard sensor for seed detection or an added stainless steel insert for fertilizer
- Mounting clamps included

Part Number	Description
46742-0701S1	Sensor 25 mm
46742-0702S1	Sensor 25 mm with Stainless Steel Insert
46742-0711S1	Sensor 32 mm
46742-0712S1	Sensor 32 mm with Stainless Steel Insert
46742-0730S1	Sensor 32 mm with Stainless Steel Outlet Coupling
46742-0720S1	Sensor 45 mm
46742-0721S1	Sensor 45 mm with Stainless Steel Insert

Hy Rate™ Grain Drill Sensor

- Delivers improved population counts
- Detects small seeds such as milo, beets, and cotton
- Compatible with many grain drill brands

Part Number	Description
46526-0010S1	Hy Rate Grain Drill Sensor

Recon Flow

- Cost-effective blockage detection
- Monitors seed and granular fertilizers and pesticides
- Use with air carts and grain drills

Part Number	Description
46742-0010S1	Recon Flow Sensor

Adapters

Part Number	Description
Sensor Tube Adapters	
46526-0040	JD 750 Sensor Adapter Kit, Rubber Tube Adapters for 4 Sensors
46205-0860S1	Recon Sensor Adapter to 1 1/4 in. Tube
46205-0861	Gray Rubber Sensor Adapter - Recon Sensor



Vigilense®



Vigilense® with Stainless Steel Outlet Coupling



Hy Rate™ Grain Drill Sensor
465260010S1



Recon Flow

Sensor Connector Pin Functions		
Pin	Color	Function
A	Green	Signal
B	Black	Ground
C	Red	Power +8V

PM Series

The PM Series of Planter Monitors offer:

- Row and ground speed monitoring
- Area and population count
- High and low population warning alarms
- Speed and area modes for quick field assessments
- Data retained in power losses
- Pre-set parameters for out-of-the-box operation
- Customizable features for advanced operation
- Multiple seed flow display options



PM100

PM100/PM100E

- Monitors 16 rows
- Automatic sensor to detect seed flow
- LED row indicators
- Multiple row failure indicator options

Part Number	Description
46794-0112S1	PM100E (8 rows)
46794-0111S1	PM100 (16 rows)



PM300

PM300/300E/332E

- Monitors 16 rows (PM300) or 32 rows (PM332)
- Monitors ground speed, two hopper level sensors, one accessory input (fan, shaft, or flow)
- Pre-programmed planter configurations for easy setup
- Stores 3 planter configurations for split row planters or multiple planters and seeders
- Adjustable target population
- Lift switch input

Part Number	Description
46799-0200S1	PM300 Monitor (16 rows)
46799-0201S1	PM300E Monitor (16 rows) Metric
46799-0380S1	PM332E Monitor (32 rows) Metric
46799-1060	PM300/400 Accessory Adapter
46799-1240	PM300/400 Accessory Adapter 2 hopper and 1 frequency (shaft, fan, or RPM) REQUIRES 46799-1060 harness
467990370S1	PM332 32 row w/ACC cable

PM Series

PM400



PM400

- Monitors 36 rows
- Monitors ground speed, two hopper level sensors, one accessory input (shaft RPM, liquid flow meter rate, or fan RPM)
- Pre-programmed planter configurations for easy setup
- Stores 3 planter configurations for split row planters or multiple planters and seeders
- Adjustable target population
- Lift switch input

PM400	
Part Number	Description
46799-0300S1	PM400 Monitor
46799-1060	PM300/400 Accessory Adapter
46799-1240	PM300/400 Accessory Adapter 2 hopper, 1 frequency (shaft, fan, RPM) REQUIRES 46799-1060 HARNESS



PM500

- Monitors 12 rows
- 12 row tramline (four rows simultaneously)
- Monitors ground speed, 2 hopper level sensors, 3 accessory inputs (shaft RPM, liquid flow meter rate, and fan RPM)
- Right and left marker input
- CAN-based external row shutoff module

PM500

PM500	
Part Number	Description
46799-0501S1	PM500 Monitor

Don't forget to select a:

- Seed Sensor
- Ground Speed Sensor
- Hopper Level Sensor
- Hall-Effect Sensor
- Flow Meter
- Implement Lift Switch

Mounting Bracket

PM300, PM400, PM500	
Part Number	Description
46799-0150	Pedestal bracket
46799-0151	Flat bracket

Accessories

Row Shutoff (PM500)



Row Shutoff Module

Row Shutoff Module/Harnesses (PM500)	
Part Number	Description
46799-0400S1	Row Shutoff Module
46799-1140	Row Shutoff Harness (12 row)
46799-1100	Row Shutoff Harness (4 row)
46799-1110	Row Shutoff Harness (6 row)
46799-1120	Row Shutoff Harness (8 row)
46799-1130	Row Shutoff Harness (10 row)

Miscellaneous Tubes & Planter Sensors

Planter Sensors	
Part Number	Description
45244-1450S1	Sure Rate small grain curved tube and sensor
45244-0971S1	Great Plains Hi Rate tube and sensor
46579-0010S3	Jeantill Plasem tube and sensor
45244-0971	SLC Hi Rate tube and sensor

Sensor Adapters

Sensor Adapters	
Part Number	Description
45960-0220S2	Sensor Adapter (old harness to new harness)
45960-0170S1	Sensor Adapter (new harness to old harness)
45968-1140	Sensor Adapter (CT harness to new harness)

Console Adapters

Console Adapters	
Part Number	Description
45841-1270	John Deere Harness to DICKEY-john® Console Adapter Harness

Accessories

Harnesses

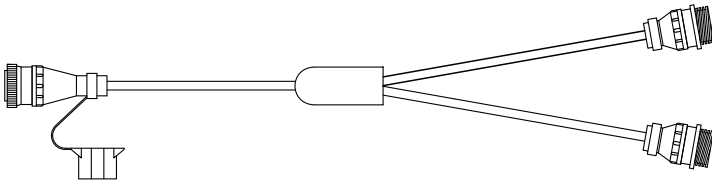

Y Cable

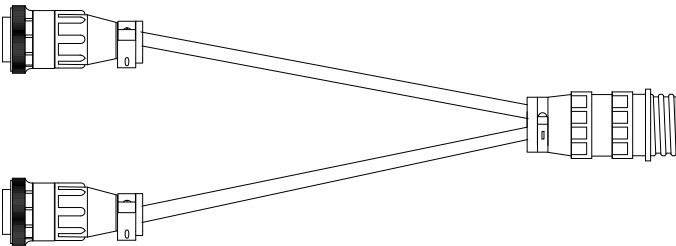

32 Row Reverse Y Harness

Use with single 32 row planter harness splitting rows 1-16 to a PDC-WSMT module and rows 17-32 to a WSMB module.

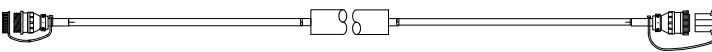

37-pin Harness Extension



Sensor Extension

Single Row Harnesses 37-pin CPC

Part Number	Rows	Description
45841-0530	4	Planter Harness
45841-0550	6	Planter Harness
45841-0570	8	Planter Harness
45841-0590	12	Planter Harness
45841-1080	16	Planter Harness
45968-0610	8	Y Cable to use 2-4 Row Planter Harnesses
45968-0960S1	12	Y Cable to use 2-6 Row Planter Harnesses
45968-0950S1	16	Y Cable to use 2-8 Row Planter Harnesses
45841-0600	16	2-8 Row Planter Harness with 1-16 Row Y Cable
45968-0940S1	24	Y Cable to use 2-12 Row Planter Harnesses
45841-0900S1	32	Y Cable to use 2-16 Row Planter Harnesses
46798-0445	32	John Deere Reverse Y Harness
46798-0446	32	Reverse Y Harness

Row Harness Kits 37-pin CPC

CASE IH		
45841-0860	12	Horizontal Fold
45968-0321		Harness Extension 30 ft.
45841-0610	16	Horizontal Fold

Kinze		
45841-0570	8	Econo Fold (6 ft. Extension required)
45841-0810	16	Harness Extension 6 ft.
45841-0590	12	Econo Fold (6 ft. Extension required)

Stacker Bar		
45841-1010	12	Tri-Cable

37-pin Harness Extensions		
45841-0810	16	Harness Extension 6 ft.
45968-0320	16	Harness Extension 15 ft.
45968-0321	16	Harness Extension 30 ft.
45841-0820S1	32	Harness Extension 15 ft.
45841-0790S1	32	Harness Extension 30 ft.

Sensor Extensions		
45968-0920		Sensor Extension 3 ft.
45968-0923S1		Sensor Extension 4 ft.
45968-0921		Sensor Extension 6 ft.
45968-0922		Sensor Extension 15 ft.

Accessories

Harnesses

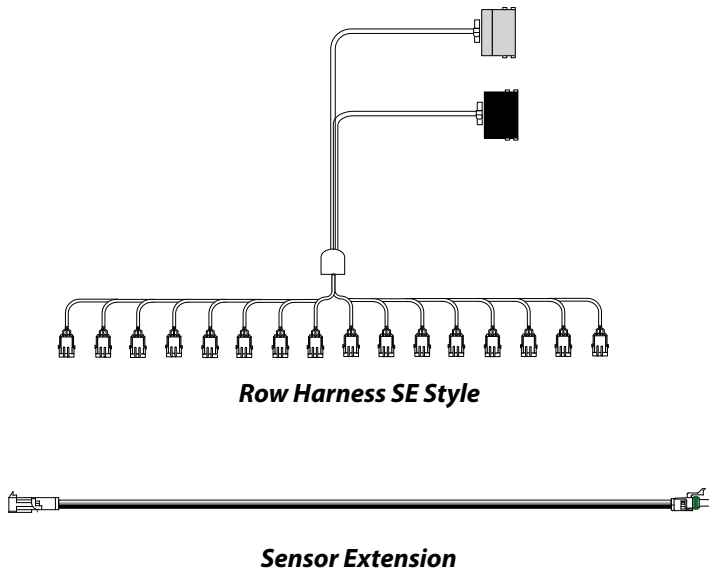

Row Harnesses SE Style RS485 Bus		
Part Number	Rows	Description
46775-1300S1	12	Harness 7.5 in.
46775-1301S1	12	Harness 15 in.
46775-1302S1	12	Harness 30 in.
46775-1310S1	16	Harness 7.5 in.
46775-1311S1	16	Harness 15 in.
46775-1312S1	16	Harness 30 in.
46775-1320S1	12	Air Cart Harness
46775-1330S1	16	Air Cart Harness
Sensor Extensions		
45968-0920		Sensor Extension 3 ft.
45968-0923S1		Sensor Extension 4 ft.
45968-0921		Sensor Extension 6 ft.
45968-0922		Sensor Extension 15 ft.

Tubes



Part Number	Description	Compatible With
46514-0040	Small, curved tube; Hi-Rate Sensor	Deere, Kinze, Great Plains
46514-0042	Small, curved tube; blank tube	Deere, Kinze, Great Plains
46153-0522	Small, curved vacuum tube; Hi-Rate Sensor, replaces 46153-0042A	Deere
46153-0062A	Small, straight vacuum tube; Hi-Rate Sensor	Deere
46514-0030C	Small, curved tube uses Hi-Rate Sensor	AGCO White
46514-0041	Small, curved tube uses Standard Rate Sensor (1/2" hole)	John Deere 7000 Series

Sensor Connector Pin Functions		
Pin	Color	Function
A	Green	Signal
B	Black	Ground
C	Red	Power +8V

Connectors/Tools

Connectors & Tools	
Part Number	Description
11059-0005	CPC Connector Kit, 37-pin, (harness)
11059-0006	CPC Connector Kit, 37-pin, (console)
11020-0010S1	Pin Extractor, CPC
11020-0013	Pin Extractor, Packard
11020-0002	Crimping Tool, CPC
42259-0003	Dust Plug (CPC Harness Connector) 37-pin Planter
42147-0003	Dust Cap 37-pin Console

Population (Counting) Sensors

Hy Rate™ Plus Sensors



**Hy Rate™ Plus Sensor
462833000S1**

- Accurately monitors seeding rates between 1 - 135 seeds per second across multiple seed types
- Utilizes a uniform 10-LED light field with virtually zero dead zones in the seed tube
- Ability to distinguish double, triple, and quad seed drops
- Reduces wind and dust effects on accurate seed counting by learning the seed type being planted

Part Number	Description
46283-3000S1	AGCO, Monosem NG Plus
46283-3003S1	John Deere "Flush Face" Seed Tubes. For use only in Cast Iron style shank found in XP series row units. Does not fit within stamped steel shank for Max Emerge, Max Emerge Plus or Pro.
46283-3002S1	Great Plains "Red" Seed Tube Air Pro (817827C)
46283-3001S1	Horsch Seed Tube



**Hy Rate™ Sensor
452440891AS1**

Hy Rate™ Sensor

- Detects small seeds like milo, beets, and cotton
- Use with many planter brands

Part Number	Description
45244-0891AS1	Hy Rate Sensor (used on seed tubes with 3/4" holes)



**UniRate™ Seed Sensor
467701002S1**

Sure Rate/UniRate™ Sensors

Part Number	Description
45244-1280S1	Sure Rate Sensor (used on seed tubes with 3/4" holes)
46770-1002S1	UniRate Sensor (used on planters without seed tubes)



**Sure Rate Sensor
452441280S1**

Sensor Connector Pin Functions		
Pin	Color	Function
A	Green	Signal
B	Black	Ground
C	Red	Power +8V

Miscellaneous Tubes and Sensors



**Small Grain Curved Tube
with Hy Rate™ Sensor
452440971S1**



**Small Grain Curved Tube for
Hy Rate™ Sensor
452440881A**



**Cyclo Sensor
461642230S3**



**Hy Rate™ Cyclo Sensor
454910750S1**



**Hy Rate™ for ASM™ Planter
467760010S1**

Planter Chutes	
Part Number	Description
John Deere 1700 Series	
45244-0971S1	Small Grain Curved Tube Hy Rate
45244-0881A	Small Grain Curved Tube (vacuum) Hy Rate
John Deere 7000/7100/7200 Series	
45244-0971S1	Small Grain Curved Tube Hyrate
15135-0008	Small Tube A25925
45244-0881A	Small Grain Curved Tube (vacuum) Hy Rate chute and sensor
Case IH	
46164-2230S3	400/500/800/900 Cyclo Air
45491-0750S1	800/900 Cyclo Air Hy Rate
46776-0010S1	Case ASM Hy Rate (sensor only) fits ASM tube
AGCO White	
45244-1010S3	6100 Hy Rate
Kinze	
45244-0971S1	Hy Rate (all models)

Miscellaneous Tubes and Sensors



**PNU Sensor
454650271**



**NG Plus Hy Rate™
452440980**



**MS Vegetable
467700100S1**



**NG Plus Meter Mount
467700351S1**



**Nodet Sensor
453520360S1**

Planter Chutes	
Part Number	Description
Monosem Planter Compatibility	
45244-0980	NG Plus Hy Rate
46770-0100S1	MS Vegetable (requires modified shoe)
46770-0090S1	Mecca 2000
46770-0351S1	NG Metermount Sensor
Nodet	
45352-0370S1	Planter II
45352-0360S1	Nodet Chute and Sensor (Weather Pack connector)
45352-0350S1	Nodet Sensor only (Weather Pack connector)
Stanhay	
46770-0220S1	Stanhay Dart II

Poly/Stainless Steel/Nylon

Available in poly or stainless steel for spraying applications.



Flow Meters



1/2" Low Flow Meter



Nylon Flow Meter



Reluctance Sensor Adapter

Features:

0.75-2 in. poly Flow Meter assemblies include:

- Flow Meter body with turbine, axle, and bearings
- Hall-Effect Sensor with 3-pin Weather Pack connector
- Hose barbs for inlet and outlet
- Viton o-rings
- Coupling nuts

3-4 in. poly Flow Meter assemblies include:

- Flow Meter body with turbine, axle, and bearings
- Hall-Effect Sensor with 3-pin Weather Pack connector
- Flanges with Viton o-rings for inlet and outlet
- Flat flanges (no o-rings)

Flow Meters (Stainless Steel)		
Part Number	Description	Flow Rate (GPM)
PMNPT70116S1	Flow Meter NPT Threads 0.5 in.	.79 - 7.9
PMNPT70121S1	Flow Meter NPT Threads 0.75 in.	1.85 - 18.5
PMNPT70126S1	Flow Meter NPT Threads 2 in.	19.00 - 198
PMNPT70136S1	Flow Meter NPT Threads 1.5 in.	9.25 - 92.5
PMNPT70146S1	Flow Meter NPT Threads 2 in.	19.00 - 198
Flow Meters (Nylon)		
46649-1170S1	GEM Flow Meter with insertable orifice 0.5 in. (output rate of 2,000 pulses per gallon)	0.3-3 w/orifice 0.5-5 w/o orifice
PM00370023S1	Flow Meter Assembly 0.75 in. with 46788-1000S1 Sensors	1.85 - 18.5
PM00370030S1	Flow Meter Assembly 1 in. with 46788-1000S1 Sensor	2.64 - 26.4
PM00370040S1	Flow Meter Assembly 1.5 in. with 46788-1000S1 Sensor	9.25 - 92.5
PM00370048S1	Flow Meter Assembly 2 in. with 46788-1000S1 Sensor	19.00 - 198
PM00370048S2	Flow Meter Assembly 2 in. with 1.5 in. Hose Barbs	19.00 - 198
PM00370068	Flow Meter only 3 in. (no Sensor or Flanges)	39.6 - 396
PM00370068S1	Flow Meter Assembly 3 in. with Flanges and Sensor with 46788-1000S1 Sensor	39.6 - 396
PM00370088	Flow Meter only 4 in. (no Sensor or Flanges)	79.0 - 790
PM00370088S1	Flow Meter Assembly 4 in. with Flanges and Sensor	79.0 - 790

Reluctance Sensor Adapter

Reluctance Sensor Adapter	
Part Number	Description
46788-1000S1	Reluctance Sensor Adapter 3-pin Weather Pack
46788-1100S1	Reluctance Sensor Adapter- Rapid Check
46788-1110S1	Reluctance Sensor Adapter, 0.5 in. Flow Meter

Velocity Sensors

Radar III



Radar III

Connector Pin Numbers ID		
Pin No.	Color	Function/Voltage
1	Black	Ground
2	Green	Signal (Sq. Wave)
3	Red	+12V
4	Red	Status

The Radar III Velocity sensor views ground surface for accurate ground speed detection.

Features:

- Compact
- Weighs only 1 lb.
- Velocity errors of less than or equal to 1-3% (vehicle speed dependent) after infield system calibration
- Can be mounted to view forward or backward from vehicle
- Replacement for Radar II

Part Number	Description
46783-1000S9	Radar III with Mounting Bracket and Hardware
46783-3000S1	Radar III Ground Speed Sensor and Damper Kit
46783-0760	Radar Mounting Plate with Hardware RVSIII
45640-2100	Radar Pipe Mounting Bracket
43940-0024	Radar Extension 10 ft.
43940-0064	Radar Extension 25 ft.
46787-0010S1	4-to-1 Radar Signal Adapter (runs 4 electronic consoles from 1 RVS III)
46783-0780	Vibration Isolation Hardware
46783-0811	MDL 24V Step-DN 4.0M cbl w/fast-on term



Radar II

Radar II



4 to 1 Adapter

Part Number	Description
45640-1912S9	Radar II with Mounting Brackets
45640-1912	Radar II with Ground Speed Sensor only
45640-2090	Flat Radar Mounting Kit
45640-2100	Radar Pipe Mounting Bracket
43940-0024	10 ft. Ground Speed Sensor Extension
46787-0010S1	4 to 1 Radar Signal Adapter

Universal Speed Sensor



Universal Speed Sensor and Magnet Kit

An economical, magnetic ground speed sensor kit.

Features:

- Magnets capture wheel rotation speed
- Easy attachment to vehicle axle and wheel
- No sprockets required or alignment with lug nuts

Connector Pin Numbers ID		
Pin No.	Color	Function/Voltage
1	Black	Ground
2	Green	Signal (Sq. Wave)
3	Red	+12V
4		N.C.

Part Number	Description
45910-0150	Universal Speed Sensor Kit (sensor, 60 magnets, muffler clamps)
45910-0190	Magnet Kit (60 magnets)
43940-0024	10 ft. Ground Speed Sensor Extension

iSpeed

Part Number	Description
46783-2020S1	iSpeed (EU Only)

Sensor Cables

Radar Y

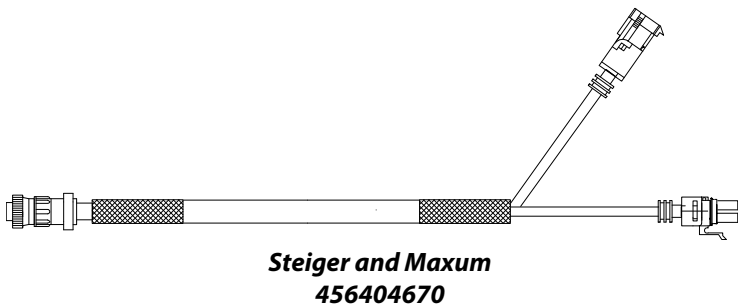
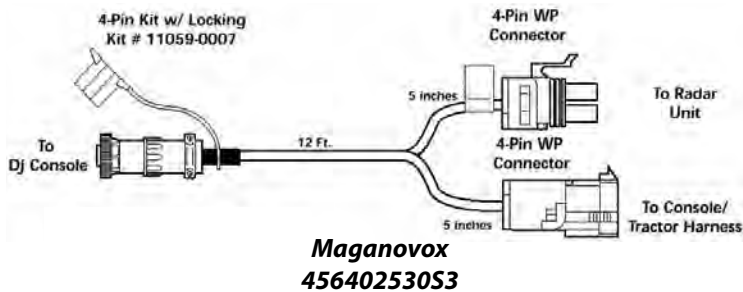
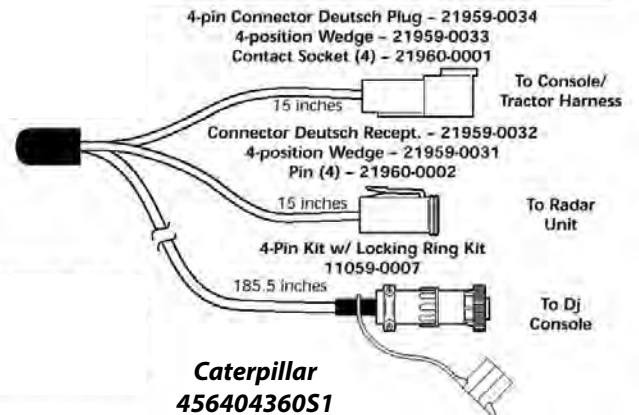
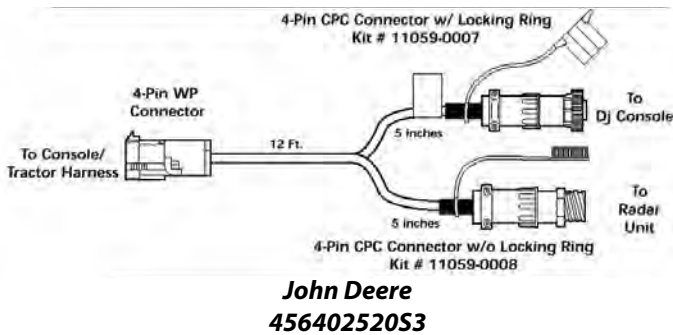
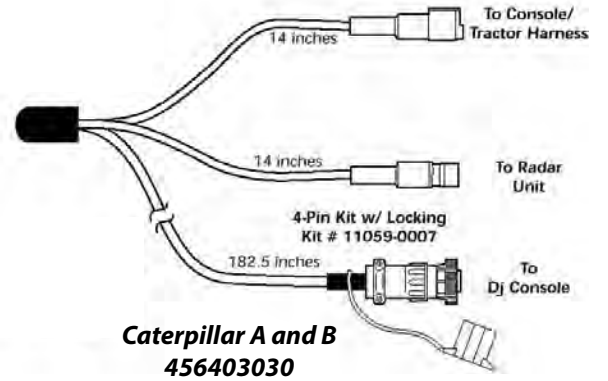
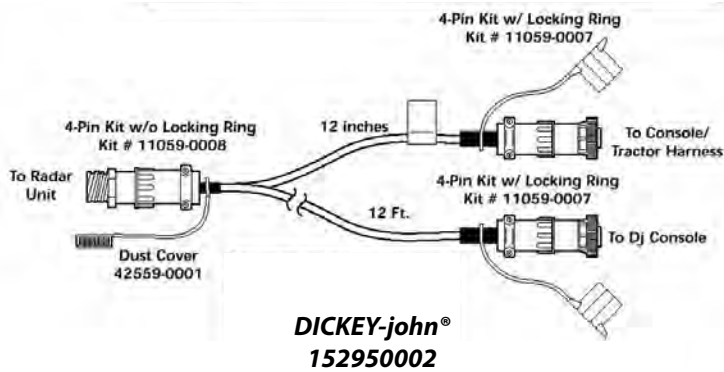

Refer to Radar Y Cross Reference.

Sensor Cables

Radar Y Cross Reference

Case IH

Model #	Y-Cable Part#	Model #	Y-Cable Part #	Model #	Y-Cable Part #
7110 Magnum	15295-0002	5210 Maxum	45640-4670	9210 Steiger	45640-4670
7120 Magnum	15295-0002	5220 Maxum	45640-4670	9230 Steiger	45640-4670
7130 Magnum	15295-0002	5230 Maxum	45640-4670	9240 Steiger	45640-4670
7140 Magnum	15295-0002	5240 Maxum	45640-4670	9250 Steiger	45640-4670
7150 Magnum	15295-0002	MX80	45640-4670	9270 Steiger	45640-4670
7210 Magnum	15295-0002	MX90	45640-4670	9280 Steiger	45640-4670
7220 Magnum	15295-0002	MX100	45640-4670	9310	45640-4670
7230 Magnum	15295-0002	MX110	45640-4670	9330	45640-4670
7240 Magnum	15295-0002	MX120	45640-4670	9350	45640-4670
7250 Magnum	15295-0002	MX130	45640-4670	9370	45640-4670
8910 Magnum	15295-0002	MX150	45640-4670	9380	45640-4670
8920 Magnum	15295-0002	MX170	45640-4670	9390	45640-4670
8930 Magnum	15295-0002	9110 Steiger	45640-4670	STX275	45640-4670
8940 Magnum	15295-0002	9130 Steiger	45640-4670	STX325	45640-4670
8950 Magnum	15295-0002	9150 Steiger	45640-4670	STX375	45640-4670
5110 Maxum	45640-4670	9170 Steiger	45640-4670	STX425	45640-4670
5120 Maxum	45640-4670	9180 Steiger	45640-4670	STX440	45640-4670
5130 Maxum	45640-4670	9190 Steiger	45640-4670	STX450	45640-4670
5140 Maxum	45640-4670				

Caterpillar

Model #	Y-Cable Part #	Model #	Y-Cable Part #	Model #	Y-Cable Part #
65A	45640-3030	65C	45640-4360S1	85D	45640-4360S1
65B	45640-3030	75C	45640-4360S1	65E	45640-4360S1
75B	45640-3030	85C	45640-4360S1	75E	45640-4360S1
35	45640-4360S1	65D	45640-4360S1	85E	45640-4360S1
45	45640-4360S1	75D	45640-4360S1	95E	45640-4360S1
55	45640-4360S1				

John Deere

Model #	Y-Cable Part #	Model #	Y-Cable Part #	Model #	Y-Cable Part #
4455	45640-2520S3	7400	45640-2520S3	7810	45640-2530S3
4555	45640-2520S3	7600	45640-2530S3	8000	45640-2530S3
4755	45640-2520S3	7700	45640-2530S3	8000T	45640-2530S3
4955	45640-2520S3	7800	45640-2530S3	8010	45640-2530S3
4560	45640-2520S3	7210	45640-2530S3	8010T	45640-2530S3
4760	45640-2520S3	7410	45640-2530S3	8300 Series*	45640-4810
4960	45640-2520S3	7610	45640-2530S3	9400 Series*	45640-4810
7200	45640-2520S3	7710	45640-2530S3		

*Note: In-Cab 2 Pin Convenience Plug

GAC® 2700



AGRI

The GAC® 2700-AGRI moisture tester provides elevator-accuracy data that producers can use throughout the farming operation. This new instrument will closely match the moisture analyzers being used at the elevator or check station to provide high confidence in receiving accurate measurement results.

The GAC 2700-AGRI has been redesigned with a larger, brighter touchscreen and an intuitive user interface to help keep your farming operation running efficiently.

Features:

- Easy-to-use, intuitive color touch screen eliminates operator training
- Accurate temperature-sensing capabilities to measure frozen and hot grain
- Stores up to 8 grain calibrations
- Memory storage for up to 3,000 measurements
- Multiple USB ports on the back of the unit for software upgrades, USB devices, and peripherals
- Additional USB ports located on the front of unit for easy calibration imports, as well as keyboard and mouse plug-ins for inputting set-up data
- Operating temperature: 36 to 113 degrees F (2 to 45 degrees C)
- Grain temperature: -4 degrees F to +113 degrees F (-20 degrees to +45 degrees C) depending on grain calibrations
- Storage/transit temperature: -4 to +140 degrees F (-20 to +60 degrees C)
- Moisture range: 5 to 45% (grain dependent)

GAC® 2700	
Part Number	Description
GAC2700AGRI	Grain Moisture Analyzer
Accessories	
46807-1541	Standard Drawer
DRAWEROPGAC2500	Bottomless Drawer
46807-1325	Drawer Sensor
20315-0005	220V Power Cord
20315-0002	110V Power Cord
20641-0003	Cleaning Brush
6015940	GAC 2700-AGRI Operator's Manual

GAC® 2500



GAC® 2500 UGMA is the Federal Standard and **NTEP Certified**

GAC® 2500-INTL Languages:

- | | |
|----------------------|------------|
| Brazilian Portuguese | Italian |
| Chinese | Latvian |
| Czech | Lithuanian |
| Croatian | Polish |
| Danish | Portuguese |
| Dutch | Romanian |
| English | Russian |
| Estonian | Serbian |
| French | Slovak |
| German | Spanish |
| Hungarian | Swedish |

UGMA & INTL

The GAC® 2500 is a commercial-use grain moisture analyzer that uses 149 MHz analysis technology. 149 MHz technology provides accurate analysis at extreme grain temperatures. This analyzer quickly tests grain and automatically calculates moisture content, temperature, and test weight (density) of the sample.

Software updates, calibrations, and new products can be imported to unit using a USB memory device. Calibrations for specialty crops are available such as Nuts, Sorghum, Popcorn, Flax, and Canola.

A complete list of calibrations can be found at the DICKEY-john® calibration web page: <http://cal.dickey-john.com/calibrations.aspx>

Models available : GAC 2500-UGMA (Federal Standard and NTEP Certified, available in U.S. only), GAC 2500-INTL

GAC® 2500 Features (All Models)

- -4 degrees F to +113 degrees F on grain moisture up to 18%
- Automatic temperature compensation
- Moisture Range 5 to 45% (grain dependent)
- Long-term storage of grain tests
- Easy-to-use color touch screen
- Large internal memory capacity
- USB and RS232 serial port connections and Ethernet
- External device compatible (keyboard, mouse, printer)
- Optional password protection

GAC® 2500 UGMA Features:

- NTEP certified, FGIS Certified, UGMA compliant
- English and Spanish languages

GAC® 2500-INTL Features:

- Equipped with 22 languages that displays user screens in the language selected
- Security switch to lock certain screens as required by the local governing agency

GAC® 2500	
Part Number	Description
GAC2500UGMAR	Grain Moisture Analyzer
GAC2500INTLR	Grain Moisture Analyzer with 22 languages
Accessories	
46807-1541	Standard Drawer
DRAWEROPGAC2500	Bottomless Drawer
46807-1325	Drawer Sensor
20315-0005	220V Power Cord
20315-0002	110V Power Cord
20641-0003	Cleaning Brush
110011505H	GAC 2500 UGMA Operator's Manual
1100111655A	GAC 2500 INTL Operator's Manual (English)

GAC® 2500



AGRI

The GAC® 2500-AGRI is an affordable moisture tester that provides elevator-like results closely matching the GAC® 2500-UGMA instrument in use at many local elevators and official check stations.

Features:

- Easy-to-use, intuitive color touch screen eliminates operator training
- Accurate temperature-sensing capabilities to measure frozen and hot grain
- Stores up to 8 grain calibrations
- Memory storage for up to 3,000 measurements
- Multiple USB ports on the back of the unit for software upgrades, USB devices, printer and peripherals
- Additional USB ports located on the front of unit for easy calibration imports, as well as keyboard and mouse plug-ins for inputting set-up data
- Operating temperature: 36 to 113 degrees F (2 to 45 degrees C)
- Power: 110/220V, 50/60 Hz, 30/35 VA
- Humidity: 20 to 90% non-condensing
- Grain temperature: -4 degrees F to +113 degrees F (-20 degrees to +45 degrees C) depending on grain calibrations
- Storage/transit temperature: -4 to +140 degrees F (-20 to +60 degrees C)
- Moisture range: 5 to 45% (grain dependent)
- Approximate weight: 25 lbs.
- Approximate dimensions: 17"H x 19"W x 14"D

GAC® 2500	
Part Number	Description
GAC2500AGRI	Grain Moisture Analyzer
Accessories	
46807-1541	Standard Drawer
DRAWEROPGAC2500	Bottomless Drawer
46807-1325	Drawer Sensor
20315-0005	220V Power Cord
20315-0002	110V Power Cord
20641-0003	Cleaning Brush
11001-1626B	GAC 2500-AGRI Operator's Manual

GAC® 2100 Series



GAC® 2100 G Series



GAC® 2100 Agri Series



GAC® 2100 Drawer

The GAC® 2100 Series delivers accurate and reliable moisture, temperature, and test weight results quickly and consistently for applications including cereals, oil seeds, grass seeds, vegetable seeds, and beans.

Features:

- Measurement through capacitance, conductance, weight
- Testing for a moisture range of at least 5 to 45% grain dependent
- Automatic temperature compensation
- Moisture repeatability of $\pm 0.1\%$ (depending on application)
- Standard RS232 output
- Power supply of 85-264 VAC, 48-62 Hz at 20 VA consumption
- 110/220 VAC

GAC® 2100			
Part Number	Description	Maximum # Grain Calibrations	Country
GAC2100AGZS9	Grain Moisture Tester	8	U.S.
GAC2100AGIARS9	Grain Moisture Tester	8	International
GAC2100GIARS9	Grain Moisture Tester	16	International
GAC2100GZS9	Grain Moisture Tester	16	U.S.
Accessories			
46422-0420BS1	Drawer		

GAC® 500XT Series

The GAC® 500XT is a compact, cost-effective unit to analyze grain moisture, temperature, and test weight anywhere on the farm with elevator-quality accuracy.



Features:

- Sixteen grain calibration memory
- Grain testing results in 25 seconds
- Automatic moisture and temperature reading
- Approximate test weight reading
- Updatable calibrations
- Semi portable
- ±0.2 moisture repeatability
- More than 450 calibrations available for download
- 110/220 volt, DC converter, or cigarette lighter power sources
- Pre-loaded with 10 languages (others available)
- Printer port
- Easily transport unit from field to field
- RS232 serial output to printer or data



Power Cord & Adapter
46795-0155

GAC® 500XT	
Part Number	Description
GAC500XTR	Grain Moisture Analyzer
Accessories	
46795-0155	Power Cord and Adapter
46795-0480	Drawer
46795-0190	6V Power Adapter



6V Power Adapter
46795-0190

mini GAC® / mini GAC® Plus

Portable Moisture Testers



mini GAC®

The handheld mini GAC® provides precision, portable moisture testing right in the field delivering "grain-trade" accuracy.

Features:

- Stores up to 20 grain calibrations with more than 450 calibrations available
- Moisture range 5 - 45% (depending on grain type)
- 0.2% moisture repeatability (depending on grain type)
- Internal scale - no pre-weighing
- USB compatibility for calibration loading
- Test grain hot or cold (32-122° F)
- Menu-driven operating system
- Automatic temperature compensation

Certain models are equipped with:

- Carry case
- Belt clip

mini GAC® with Language Group 1 Languages: English US, English UK, English AU, French, German, Italian, Spanish, Portuguese, Dutch, Danish, Polish	
Part Number	Description
MINIGAC1R	mini GAC with a lithium battery
MINIGAC1RA	mini GAC without a battery
MINIGAC1ER	mini GAC with a lithium battery with operator's manual
MINIGAC1ERA	mini GAC with operator's manual without a battery
MINIGAC1EAPR	mini GAC with a lithium battery with accessory pack
MINIGAC1EAPRA	mini GAC with accessory pack without a battery

mini GAC® with Language Group 2 Languages: English US, Turkish, Romanian, Finnish, Serbian, Croatian, Hungarian, Czech, Slovak, Afrikaans	
Part Number	Description
MINIGAC2R	mini GAC with a lithium battery
MINIGAC2RA	mini GAC without a battery

mini GAC® with Language Group 3 Languages: English US, Russian, Bulgarian	
Part Number	Description
MINIGAC3R	mini GAC with a lithium battery
MINIGAC3RA	mini GAC without a battery

mini GAC® / mini GAC® Plus

Pre-programmed Calibrations for English U.S.

- | | |
|-------------|-----------------|
| • Barley 2R | • Rye |
| • Barley 6R | • Safflower |
| • Corn | • Sorghum |
| • Corn Hi | • Soybeans |
| • Durum | • Sunflower Oil |
| • Millet | • Wheat HRS |
| • Oats | • Wheat HRW |
| • Rapeseed | • Wheat SRW |

(other languages may have a different calibration set than listed above)

mini GAC®: Model measures moisture only and comes shipped in a cardboard box.

mini GAC® Plus

mini GAC® Plus: Tester measures moisture and test weight. Includes carry case and belt clip.



mini GAC® Plus
(Carry Case and Belt Clip included with some models)



Portable Moisture Testers

mini GAC® Plus with Language Group 1	
Languages: English US, English UK, English AU, French, German, Italian, Spanish, Portuguese, Dutch, Danish, Polish	
Part Number	Description
MINIGAC1PR	mini GAC Plus with a lithium battery
MINIGAC1PRA	mini GAC Plus without a battery

mini GAC® Plus with Language Group 2	
Languages: English US, Turkish, Romanian, Finnish, Serbian, Croatian, Hungarian, Czech, Slovak, Afrikaans	
Part Number	Description
MINIGAC2PR	mini GAC Plus with a lithium battery
MINIGAC2PRA	mini GAC Plus without a battery
MINIGAC2APR	mini GAC Plus with a lithium battery with accessory pack
MINIGAC2APRA	mini GAC Plus with accessory pack without a battery

mini GAC® Plus with Language Group 3	
Languages: English US, Russian, Bulgarian	
Part Number	Description
MINIGAC3PR	mini GAC Plus with a lithium battery
MINIGAC3PRA	mini GAC Plus without a battery

Accessories	
Part Number	Description
46789-1160	Carry Case
46789-0950	Belt Clip
46789-0860S1	Funnel Scoop Assembly

mini GAC® 2500

The most accurate handheld moisture tester that provides fast and easy results. Now with 149 MHz - UGMA technology to match the new moisture testers at the elevator.

Features:

- Simplifies operation with menu-driven interface
- Eliminates pre-weighing with an internal scale
- Avoids cumbersome screw caps that can cause grain damage and oily residue
- Easily loads calibrations through a USB port
- Tests hot or cold grain between 32 and 150°F (0 - 66°C), grain and moisture dependent (check the Dj website for specific calibration parameters)
- Receives accurate measurements in a variety of conditions with automatic temperature compensation



mini GAC® 2500



Portable Moisture Testers

mini GAC® 2500 for the Americas

Languages: English (US), French (Canadian), Spanish, Portuguese

Part Number	Description
MINIGAC2500BT	Bluetooth tester with a lithium battery
MINIGAC2500BTA	Bluetooth tester without a battery
MINIGAC2500NBT	Non-Bluetooth tester with a lithium battery
MINIGAC2500NBTA	Non-Bluetooth tester without a battery

mini GAC® 2500 for Western Europe

Languages: English (UK), French, German, Italian, Portuguese, Spanish, Dutch

Part Number	Description
MINIGAC2500BT1	Bluetooth tester with a lithium battery
MINIGAC2500BTA1	Bluetooth tester without a battery

mini GAC® 2500 for Eastern Europe

Languages: English (US), Serbian, Hungarian, Romanian, Czech, Slovak, Polish

Part Number	Description
MINIGAC2500BT2	Bluetooth tester with a lithium battery
MINIGAC2500BTA2	Bluetooth tester without a battery
MINIGAC2500NBT2	Non-Bluetooth tester with a lithium battery
MINIGAC2500NBTA2	Non-Bluetooth tester without a battery

mini GAC® 2500 for the Baltic Countries

Languages: English (US), Lithuanian, Latvian, Estonian

Part Number	Description
MINIGAC2500BT4	Bluetooth tester with a lithium battery
MINIGAC2500BTA4	Bluetooth tester without a battery
MINIGAC2500NBT4	Non-Bluetooth tester with a lithium battery
MINIGAC2500NBTA4	Non-Bluetooth tester without a battery

mini GAC® 2500 for the remainder of Europe

Languages: English (US), Turkish, Finnish, Danish

Part Number	Description
MINIGAC2500BT3	Bluetooth tester with a lithium battery
MINIGAC2500BTA3	Bluetooth tester without a battery
MINIGAC2500NBT3	Non-Bluetooth tester with a lithium battery
MINIGAC2500NBTA3	Non-Bluetooth tester without a battery

mini GAC® 2500 for Africa

Languages: English (US), Afrikaans, French, Dutch, Portuguese

Part Number	Description
MINIGAC2500BT5	Bluetooth tester with a lithium battery
MINIGAC2500BTA5	Bluetooth tester without a battery
MINIGAC2500NBT5	Non-Bluetooth tester with a lithium battery
MINIGAC2500NBTA5	Non-Bluetooth tester without a battery

M3G™/M20P™



M3G™/M20P™



Lid/Cup

Note: M3G™/M20P™ is not available in EU Countries due to not being RoHS Compliant

46789-0500S1

- Barley 2R
- Barley 6R
- Corn
- Dactyle
- Durum
- Horsebean
- Lupine
- Oats
- Peas
- Rapeseeds
- Ray Grass
- Rice
- Rye
- Soybeans
- Sunflower
- Triticale
- Wheat (Soft)

46789-0502S1 (US Version)

- Barley 2R
- Barley 6R
- Corn
- Dactyle
- Durum
- Horsebean
- Lupine
- Milo
- Oats
- Peas
- Rapeseeds
- Ray Grass
- Rice
- Rye
- Soybeans
- Sunflower
- Triticale
- Wheat (HRWW)

Portable Moisture Testers

The M3G™/M20P™ portable moisture testers provide high-speed, repeatable moisture testing in a lightweight unit.

- Moisture readings and averages can be stored for up to 10 individual samples
- ±0.5% repeatability with normal stored grain
- Scoop or catch sample
- Density compensation without weighing or compressing samples
- Lid/cup for storage only

M3G Features:

- Basic moisture testing
- Test up to 3 grains
- Pre-programmed calibrations for Corn, Soybeans, and Wheat (Additional calibrations are found in the M3G™ Product Support page on our website)

M20P Features:

- Basic moisture testing
- Test up to 20 grains
- Pre-programmed calibrations for Corn, Soybeans, Wheat, Rice, Oats, Sunflowers, Peas, Durum, Triticale, Rye, English Ray Grass, Horsebean, Dactyle, Rapeseed, Barley, Lupine, Milho Alta and Baixa (Portugal), Milo (US), Soja (Portugal), Trigo (Portugal). Additional calibrations are found in the M20P Product Support page on our website.

M3G	
Part Number	Description
46789-0010S1	M3G Moisture Tester
46789-0014S1	M3G Moisture Tester; pecan calibration only.
46789-0140	Lid/Cup

M20P	
Part Number	Description
46789-0500S1	M20P Moisture Tester
46789-0502S1	M20P Moisture Tester (US Version)
46789-0140	Lid/Cup

Instalab® 700 NIR Product Analyzer

The Instalab® 700 (IL700) is a self-contained optical reflectance instrument designed to quickly and accurately measure the percent of constituent concentration (moisture, protein, oil, starch, fiber, ash, etc.) in a wide range of commodities common to the grain, feed, and food industries. Near Infrared reflectance (NIR) technology within the unit analyzes numerous solid, semi-solid, and liquid materials and is an alternative to wet chemistry. With sufficient calibration data, the Instalab provides accuracy comparable to laboratory results.



Features:

- 110/220 VAC
- Automatic and manual gain selection adjusts the gain for low-reflectance samples
- Thermo-electrically-cooled detector that maximizes sensitivity and dynamic range
- A completely sealed and thermally isolated optics chamber
- An integrated, computerized self-test mode to continuously monitor instrument performance and pinpoint errors
- Non-volatile flash memory stores calibrations and other system parameters

Applications:

- Grain processing
- Feed processing
- Meat processing
- Textile manufacturing
- Flour milling
- Ethanol production
- Vegetable oil processing
- Dairy product processing

Languages:

- English (default)
- Czech
- French
- German
- Hindi
- Hungarian
- Italian
- Japanese
- Polish
- Portuguese
- Romanian
- Russian
- Serbian
- Spanish
- Ukrainian

Instalab® 700 Series		
Part Number	Application	Description
IL710R	Custom	6 filters, 4 customer-selected filters, more than 50 wavelengths available for special applications
IL710EPR	Ethanol	Special configuration for the DDG market
IL710FGR	Flour milling	10 filters, 650 NM optical filter for color measurement, fiber and cellulose determination
IL710FMR	General purpose dry milling grain/feed	10 filters, dry milling grain/feeds, 650 NM optical filter
IL710GLR	Glucose	Glucosinolates
IL710MCR	Dairy	10 filters, Food ingredients and grain such as meat, cheese, dairy, poultry, fishmeal, and bonemeal products
IL710SBR	Protein/oil in soybeans/wet corn milling	10 filters
IL704R	Moisture/Protein	For wheat, flour, barley, milo, oats type products
IL706R	Moisture/Protein/Fat/Oil	6 filters, moisture, protein, oil/fat, starch, fiber, ash, and other constituents in products such as Wheat, Corn, Soybean, Sunflower, Rapeseed, Barley, Milo, Oats, Alfalfa
IL707FMR	General/ Dry Milling	7 filters, 650 NM optical filter for color measurement, fiber and cellulose determination, dry milling of grain and animal feeds
IL707R	Grain	Moisture, protein, oil/fat, starch, fiber, ash, and other constituents in products such as Wheat, Corn, and Soybean

Instalab® 700 Accessories

IL700 offers numerous cup styles for a variety of applications. The unit is shipped with the standard cup and tool accessory kit. All other cups are optional.

- Standard cup
- Liquid stainless steel cup for liquid/ethanol material
- Open sample cup for semi-solid (pastes and slurries) and solids (meats and cheeses)
- Large open cup for whole sample-type grain



IL700 Standard Sample Cup



IL700 Liquid Sample Cup



IL700 Open Sample Cup/Holder



IL700 Large Open Sample Cup/Holder



IL700 Sample Tool Accessory Kit

Instalab® 700 Accessories	
Part Number	Description
46811-1330S1	Air Filter/Cover/Guard (housing) Assembly
46811-1330S2	5-Pack of Air Filters (w/o housing)
11021-0002	Standard Sample Cup
45592-1650	Open Sample Cup (tray/3 cups)
46803-0100	Liquid Sample Cup Cover (liquid/ethanol)
46803-0110	Liquid Sample Cup Base (liquid/ethanol)
46811-1211	Large Open Sample Cup 4" Holder
46811-1410	Large Open Sample Cup 4"
46811-1440	Sample Tool Accessory Kit (scoopula, handle, 2 brushes, spatula)
20845-0003	Scoopula and Scoopula Handle
21114-0001	#54 Brush 1"
21114-0002	#9501 Brush 3/8"
11021-0005	Spatula
11001-1574	IL 700 Operator's Manual

Printer and Accessories



Strip Printer

Printer	
Part Number	Description
466780011	RS232 Printer (Gray)
466780012	USB Printer (Gray)



RS232 Cable (9-pin Female to 9-pin Male)

Printer Accessories	
Part Number	Description
220120002	Printer Cable 25M to 25M (GAC 2100, 500XT)
220120003	RS232 Cable 9-pin F to 9-pin M (GAC 2500, IL700)
220490001	DB9 Null Modem Adapter 9-pin
220490002	Gender Changer 9-pin
220490003	Null Modem Adapter 25-pin
220120004	USB Type A to B Cable (GAC 2500, mini GAC, IL700)



RS232 Cable (25-pin Male to 25-pin Male)



Gender Changer



USB Type A to B Cable



Null Modem Adapter

Tester

A Soil Compaction Tester is used by pushing into the ground at different locations to find problem areas that can inhibit root growth and reduce yields.

Features:

- Rugged, molded housing and handle
- Color-coded stainless steel dial, liquid filled to reduce shock
- Stainless steel rod with marks at regular intervals



Soil Compaction Tester	
Part Number	Description
15585-0003AS1	Soil Compaction Tester (Imperial)
15585-0015S1	Soil Compaction Tester (Metric)
46347-0040	Replacement Tip 1/2 in.
46347-0010	Replacement Tip 3/4 in.

Typical Compaction Situation

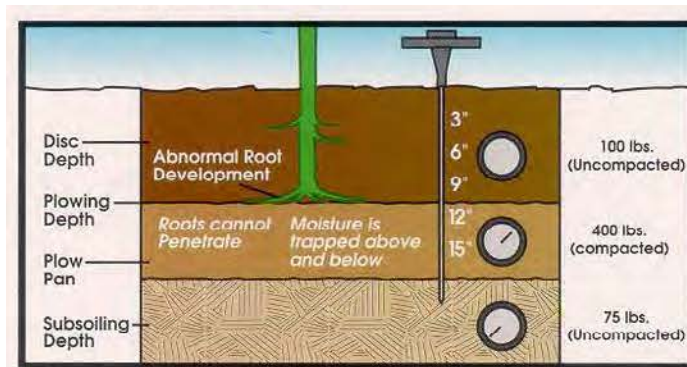



Application Rate Sensor

Application Rate Sensor Tester

An Application Rate Sensor Tester quickly tests sensors installed on a vehicle. The tester provides an audible alarm with each degree of rotation from the application rate sensor.

Features:

- Battery operated
- No external power source required

Part Number	Description
45007-0066	Application Rate Sensor Tester



Seed Tester 90

Seed Tester 90

Seed Tester 90 accurately verifies sensor operation.

Features:

- Battery operated
- No external power source required

Part Number	Description
45007-006553	Seed Tester 90



Seed Simulator

Seed Simulator

Simulates seed sensor and radar ground speed signals on planters up to 36 rows. Can demonstrate functionality of most DICKEY-john® planter monitors (PM100, 200, 300, 400, 500, 600, 1000, 3000, Seed Manager® SE and ASM™ II). An adapter cable is required to connect to the appropriate planter monitor.

Features:

- Replicates one or all row failure
- Reproduces two seeding rates for both Corn and Soybeans
- Checks the planter monitor +8 volt supply to the seed sensors and +12 volt supply to radar

Part Number	Description
46790-1000S1	Seed Simulator



Vehicle Ground Speed Simulator 200

Vehicle Ground Speed Simulator

Simulates speed signal input from Radar II and III ground speed sensor ensuring that cabling and console are accepting inputs.

Part Number	Description
45640-4511S1	Vehicle Ground Speed Simulator (VGSS200)

Adapters

An adapter cable is required to connect the planter monitor to the simulator/tester.



PM100 Adapter Cable



PM300 Adapter Cable



PM400 Adapter Cable



PM500 Adapter Cable



ASM™ II/Seed Manager® Simulator Adapter Cable



ASM™ II/Seed Manager® Console Adapter Cable

Adapters	
Part Number	Description
46790-1010	PM100 Adapter
46790-1020	PM300 Adapter
46790-1030	PM400 Adapter
46790-1040	PM500 Adapter
46790-1050	ASMII/Seed Manager SE Console Adapter
46790-1060	ASMII/Seed Manager SE Simulator Adapter

**Service parts are available in limited quantities.
Contact the technical support team for
availability at 1-800-637-3302.**

**Products contained in the Service Parts
section include:**

- AI-50 and AI-100 Virtual Terminals
(*AI-100 no longer available*)
- MVT
- Land Manager® Models I, II, and SE
- Single Thermal Transfer Unit Components
- Hydraulic Servo Valve
- Flow Meter Nylon Parts
- Connectors and Kits
 - Weather Pack
 - Amp, ITT Cannon
 - Deutsch

AI-50 Virtual Terminals

The AI-50 Virtual Terminals are discontinued products; however, some harnessing is still available as service parts.



AI-50 Virtual Terminal-discontinued

5" Virtual Terminal	
Part Number	Description
Service Parts	
46798-0452	Tractor CAN Harness
46798-0455	System Power Harness with IBBC connector
46798-0450	System Power Harness with Deutsch connector (not standard in kit)
11011-6416	Ty-Wrap Bundle 64-7 in. and 16-14 in.
Options:	
46798-0450	System Power Harness without IBBC Connector

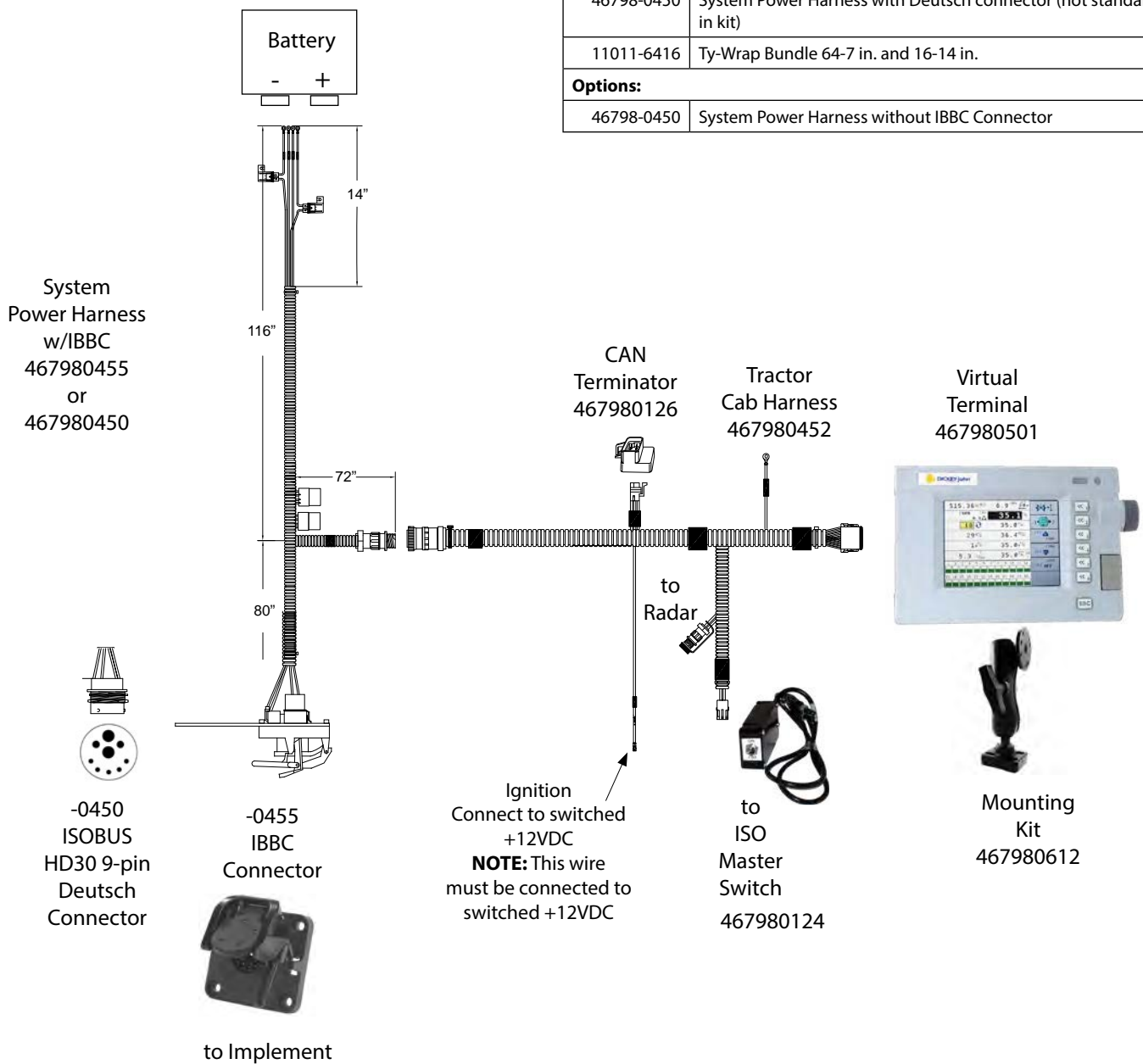

AI-100 10" Virtual Terminal

The AI-100 Virtual Terminals are discontinued products; however, some harnessing is still available as service parts.



AI-100 Virtual Terminal-discontinued

10" Virtual Terminal	
Part Number	Description
Service Parts	
46798-0451A	Tractor Harness
46798-0455	System Power Harness w IBBC Connector
46798-0450	System Power Harness 9-pin Deutsch Connector (not standard in kit)
46798-5060S1	Tractor Electronic Control Unit (TECU)
11011-6416	Ty-Wrap Bundle 64-7 in. and 16-14 in.

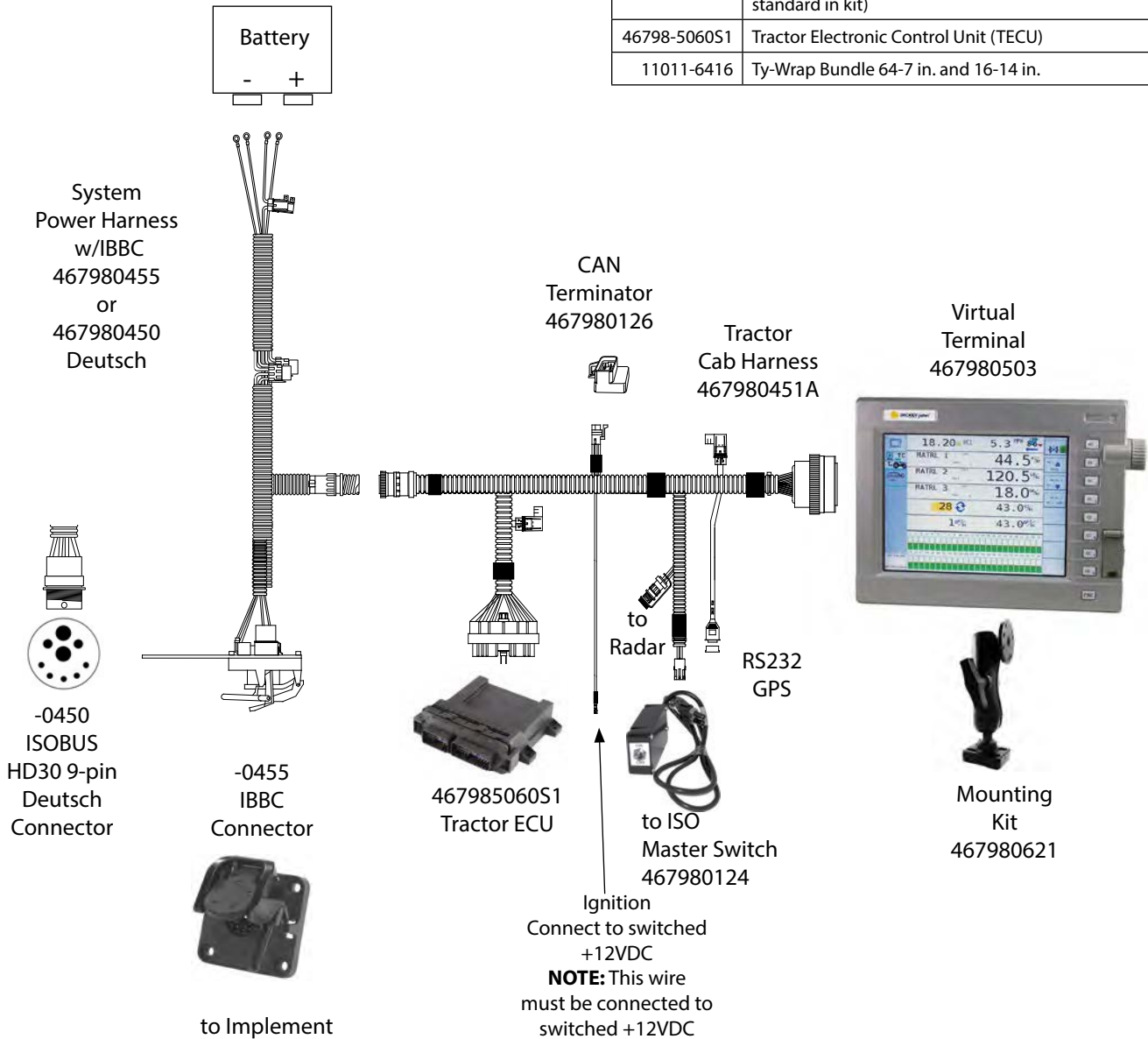

Seed Manager® SE

The Seed Manager® SE monitors material flow or population up to a total of 96 rows for planter, drills, and air carts. Any combination of modules can be used up to a maximum of 7 modules.

Three available modules:

- Material flow with hopper level (12 rows with 2 hopper level inputs)
- Material flow without hopper level (16 rows)
- Air cart (2 fan speed, 3 shaft speed, 2 pressure, 2 hopper inputs)

Features:

- Population count for all rows
- Population for the first row in each module and material flow for all other rows
- Acre count
- Population monitoring
- Ground speed monitoring
- Seed spacing monitoring
- Seed count
- RS485 communication modules



Seed Manager® SE



Module

Don't forget to select a:

- Seed Sensor
- Ground Speed Sensor
- Hopper Level Sensor
- Hall-Effect Sensor
- Flow Meter
- Implement Lift Switch

Part Number	Description
Console	
46682-2000S1	Seed Manager SE Console (obsolete and no longer available)
46682-0133S1	Seed Manager SE Console Cab Harness (short)
46682-0134S1	Seed Manager SE Console Cab Harness (long)
Module	
46775-1120S1	2 Hopper Module, 12 row
46775-1130S1	Module, 16 row
46775-2020S1	Air-cart Monitoring Module
Implement Harness	
46775-1300S1	Harness, SMSE, 7.5 in., 12 row
46775-1301S1	Harness, SMSE, 15 in., 12 row
46775-1302S1	Harness, SMSE, 30 in., 12 row
46775-1320S1	Tower Harness, SMSE, 12 row
46775-1310S1	Harness, SMSE, 7.5 in., 16 row
46775-1311S1	Harness, SMSE, 15 in., 16 row
46775-1312S1	Harness, SMSE, 30 in., 16 row
46775-1330S1	Tower Harness, SMSE, 16 row
46775-2041S1	Air-cart Module Harness
485 Module Extension	
46775-1200S1	Module Extension 4 ft.
46775-1201S1	Module Extension 6 ft.
46775-1202S1	Module Extension 10 ft.
46775-1203S1	Module Extension 15 ft.
46775-1204S1	Module Extension 20 ft.
46775-1205S1	Module Extension 25 ft.
46775-1206S1	Module Extension 30 ft.
46775-1207S1	Module Extension 40 ft.
46775-1208S1	Module Extension 45 ft.
46775-1209S1	Module Extension 55 ft.

Seed Manager® SE Implement Layout

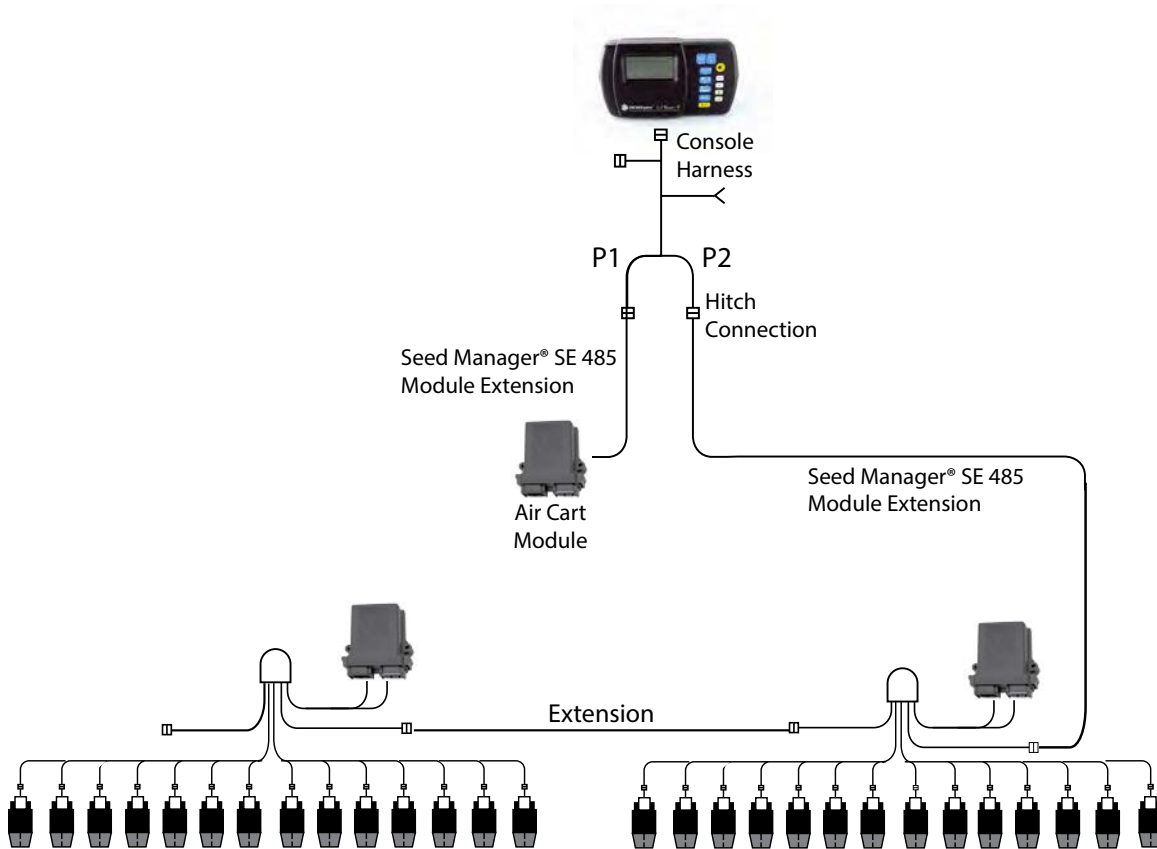

PM200E

PM200E/250

- Monitors 12 rows
- Speed area monitoring
- Implement population average (200E)
- Plug-in replacement for other DICKEY-john® monitors

Part Number	Description
46799-2085S1	PM200E Monitor (12 rows) Metric
46799-2090S1	PM250 Monitor (12 rows)

IntelliAg® MVT

MVT



IntelliAg® MVT 40 Color Display



IntelliAg® MVT 70 Color Display

MVT 40 Virtual Terminal Features:

- High definition 4.3" color display console
- Eight hard keys and rotary dial for operation and setup

MVT 70 Virtual Terminal Features:

- High definition 7" color display console
- Touch Screen with soft keys for menu navigation

Planter Control Module provides:

- Maximum of two closed loop control channels
- Outputs to control valves (2 PWM and 2 Servo)
- Accessory sensor inputs (3 Hopper Level, 3 Air Pressure, 2 RPM, Implement Lift)
- 12 population/blockage sensors and addition of a WSMB or WSMB2 to monitor a maximum of 84 rows
- Optional shutoff drivers (output modules) for manual section control



Planter Control Module
472940230S1



WSMB Module
467981100S1

IntelliAg® MVT is a two-channel control system for row crop planters that allows for application of 2 separate products or sections of the planter while simultaneously monitoring up to 84 seed sensors for individual row performance and population. In addition, the system offers optional manual individual 24-row section control. The IntelliAg® MVT can also be used as a planter population monitor only. Options available for in-cab operations including programming, material selection, rate change, and general operation.

The IntelliAg MVT system includes the following required components:

- Virtual terminal
- (1) Planter Control Module (PCM)
- (2) CAN terminators
- Cab and implement harnessing

Optional components include:

- Working Set Member Modules (WSMB) Up to 5 Working Set Member Modules (monitors up to a total of 84 rows of seed input)
- Implement Lift
- Clutch/Switch Module and Planter Output Module
- Remote Test Switch (required for Continuous Test and 5 Rev Test)
- Compatible with all DICKEY-john® sensors

IntelliAg® MVT System Components	
Part Number	Description
472940115	MVT 7" Terminal
472940255	MVT 7" Mounting Bracket Kit
472940110	MVT 4.3" Terminal
472940120	MVT 4.3" Mounting Bracket Kit
467980612	RAM Mount
467980450	System Power Harness
472940130	IntelliAg MVT Terminal Harness (MVT40 and MVT70)
467980131	20' Hitch Extension
472940230S1	PCM WSMT2 MVT only
472940200	WSMT Planter Control/Monitoring Harness with 37-pin CPC Planter Harness Connector
472940150	WSMT Planter Control/Monitoring Harness with Deutsch Planter Harness Connector
472940140	WSMT Planter Monitoring Only Harness with Deutsch Planter Harness Connector
472940180	WSMT Planter Monitoring Only Harness with 37-pin CPC Planter Harness Connector
467981100S1	WSMB Module (18 seed rows)
467988320S1	WSMBII Module (18 seed rows with singulation, seeding quality, skips and doubles)
467981200	WSMB Harness to PM Style Harness 37-pin CPC
467981201A	WSMB Harness to SE Style Harness Deutsch connector

IntelliAg® MVT

Cab Harnessing

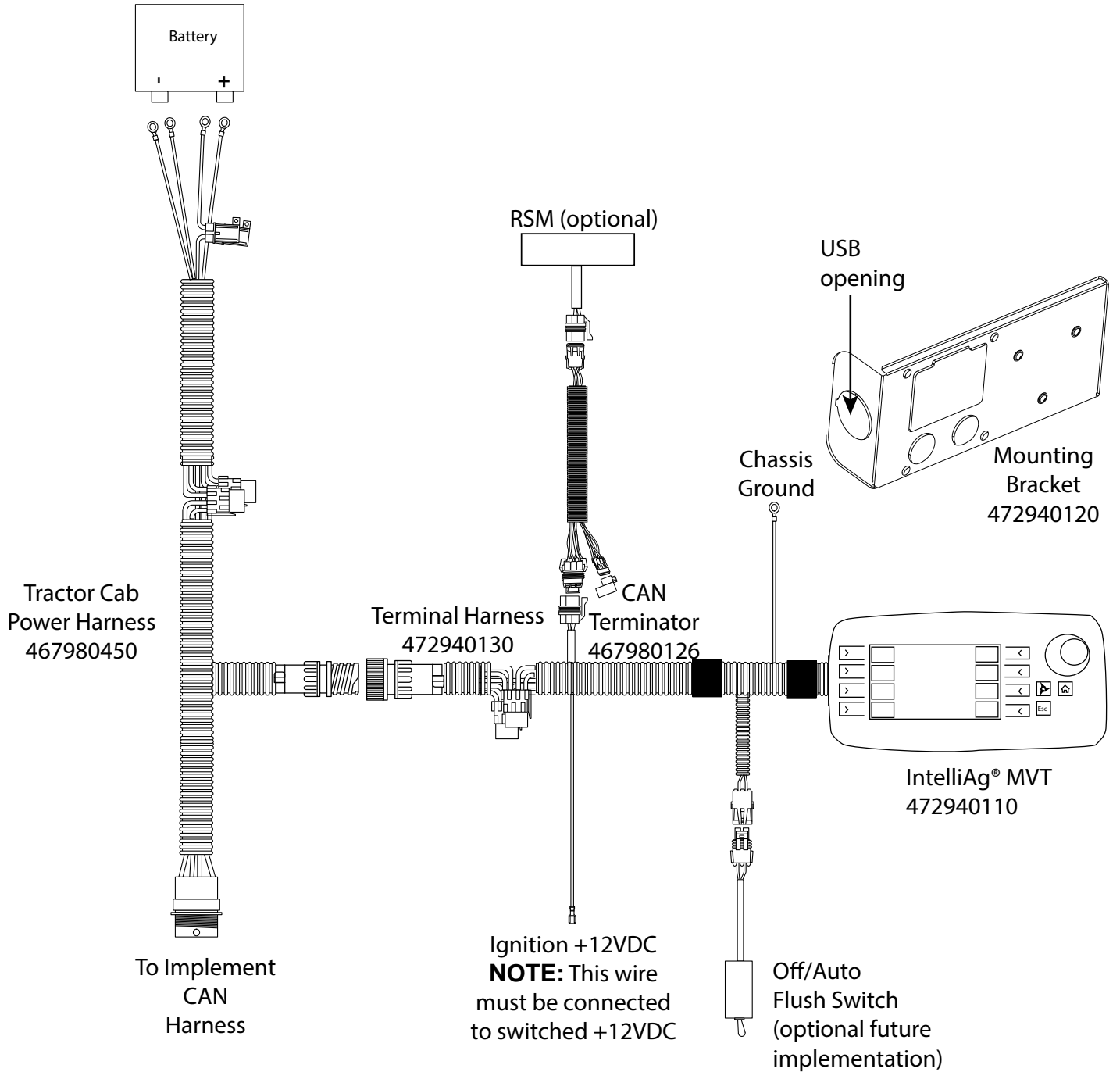

IntelliAg® MVT

Implement Harnessing

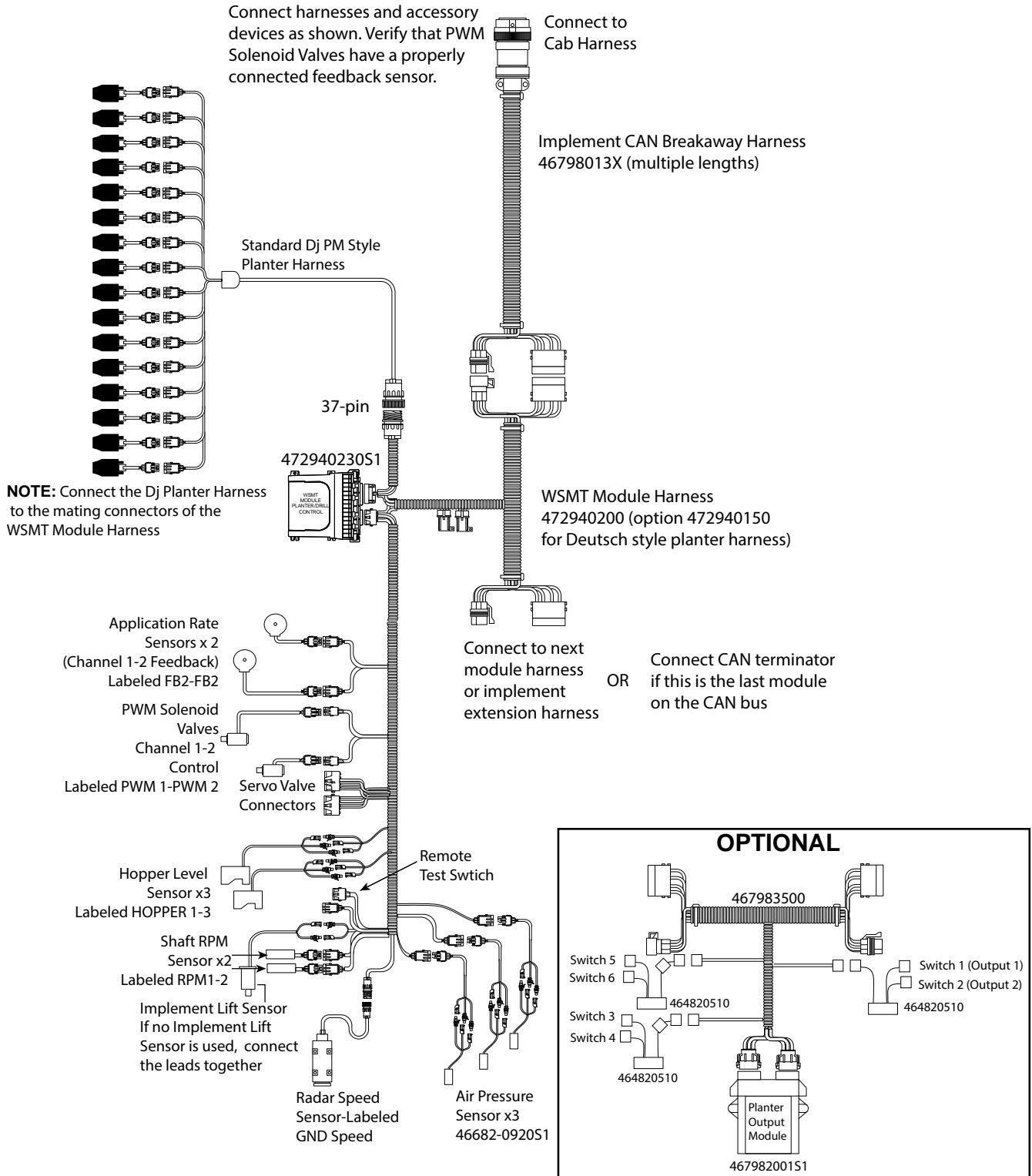

IntelliAg® MVT

Implement Harnessing

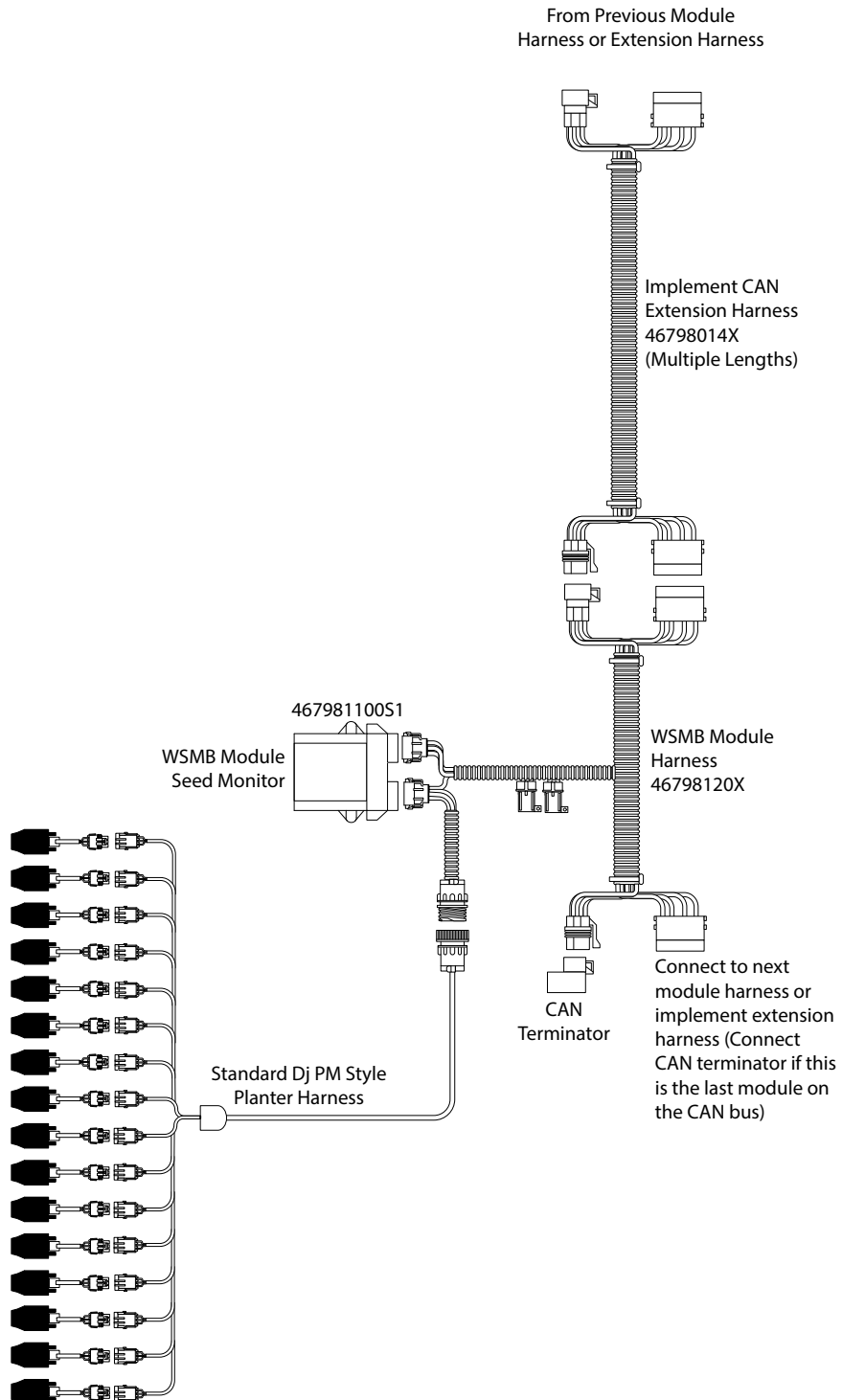

Controller

Land Manager[®] Models I, II, and SE



Land Manager[®] I



Land Manager[®] II



Land Manager[®] SE

Don't forget to select a:

- Radar Speed Sensor
- Ground Speed Sensor
- Universal Distance (magnetic) Sensor
- Radar Y Cable
- Control System Kit

Land Manager[®] controllers are used to control fertilizer and chemical applications including:

- Liquid Flow
- Liquid Pressure
- Granular
- Anhydrous Ammonia

Three Land Manager consoles are available:

- Land Manager[®] I
- Land Manager[®] II
- Land Manager[®] SE

Land Manager[®] I & II controls:

- Liquid
- Granular
- NH₃ liquid flow
- Pressure-based, 2 digital accessories (fan RPM, hopper level, 1 analog accessory) or,
- One analog accessory (pressure sensor, temperature sensor standard RS232 port for GPS or printer)
- 10 boom section inputs

Land Manager[®] I & II Features:

- Variable rate application control
- Application library stores up to 10 configurations
- Creates and logs up to 10 individual reports
- Standard RS232 interface link for easy field software upgrades and upload/download of formal report information
- Records tank fill (with optional flow meter)
- Automatic pump shutoff
- Auto gain tunes responsiveness to application

Land Manager[®] II Features only:

- Dual channel
- Spray and spread with one console

Land Manager[®] SE controls:

- Liquid
- Granular
- NH₃ liquid flow
- Pressure-based, 1 digital accessory (fan RPM, hopper level, vapor detector)
- 6 boom section inputs

Land Manager[®] SE Features:

- One button setup

Controller

Land Manager® Systems

A complete DICKEY-john® Land Manager® system consists of six components:

- Display console
- Master switch module
- Ground speed sensor
- Feedback device to monitor application rate
- Actuator device to regulate the application rate
- Harness system

Part Number Codes

- LM1 One channel Land Manager
- LM2 Two channel Land Manager
- LMSE Land Manager SE version
- T Truck Harness
- PS Pull Type Short Harnessing
- PL Pull Type Long Harnessing
- R Radar
- U Universal Distance Sensor
- Y Radar "Y" Cable

Nylon Liquid Flow Meter Ratings

Flow Meter	Flow Rate
1/2"	.3 - 5 GPM
3/4"	1.85-18.5 GPM
1"	2.64-26.4 GPM
1.5"	9.25-92.5 GPM
2"	19.00-198 GPM
3"	39.6-396 GPM
4"	79.0-790 GPM

To calculate liquid flow rates (GPM):

Width x Speed x Application Rate (GPA) x .00202
 60 ft. x 15 mph x 20 gpa x .00202 = 36.36 GPM

To calculate NH3 or granular flow rates (lbs/hr):

Width x Speed x Application Rate (GPA) x .1212
 42.5 ft. x 6 mph x 200 lbs NH3 x .1212 = 6181 lbs/hr

Maximum flow on pressure kits is based on 100 psi. Maximum flow rate for NH3 is based on 110 psi tank pressure. Ensure these pressures are accounted for when selecting systems.

Land Manager® (1 channel/LM1)	
Part Number	Description
LM1/CCS Retro	Land Manager Console with CCS Retro Harness
LM1E	European LM System Sprayer Harness
LM1PL	LM1 System with Pull Type Long Harness
LM1PS	LM1 System with Pull Type Short Harness
LM1T	LM1 System with Truck Harness

Land Manager® (2 channel/LM2)	
Part Number	Description
LM2PL	LM2 System with Pull Type Long Harness
LM2PS	LM2 System with Pull Type Short Harness
LM2T	LM2 System with Truck Harness

Land Manager® SE System	
Part Number	Description
LMSEP	Land Manager SE with Pull Type Harness
LMSET	Land Manager SE with Truck Harness

Pressure			
Part Number	Description	Valve Size (Inches)	Maximum Flow Rate
L2P	Valve with 100 psi Transducer	2	220 GPM
L3P	Valve with 100 psi Transducer	3	600 GPM
LSP	Hydraulic Valve with 100 psi Transducer	Specify	
Nylon Flow			
L2POLYF	Ball Valve with 2 in. Flow Meter	2	19-198 GPM
NH3			
CCSNH3KIT	CCS NH3 System	3/4	4200 LBS/HR

Radar Y Cables (Complete listing on pages 125-126)	
Part Number	Description
15295-0002	Radar Y (DICKEY-john® Radar to 2 console)
45640-2520S3	Radar Y (DICKEY-john® Radar to John Deere Dash and Console)
45640-2530S3	Radar Y (John Deere Magnavox Radar to Dash and Console)
45640-3030	Radar Y (Challenger A or B Series Cat Radar to Dash and Console)
45640-4360S1	Radar Y (Challenger C Series Cat Radar to Dash and Console)
45640-4670	Radar Y (Steiger and Maxum Radar to Dash and Console)
45640-4810	Radar Y (John Deere in-cab Radar Convenience Plug Adapter)

LM1 and LM2 Kits

LM1 Kits

LM1E

Component	Item Description	Qty
LM1CSLOPT1	CSL, LAND MANAGER, PICK TO ORDER	1
466390910S1	MTG BRACKET KIT LM	1
466050030	MASTER SW MODULE ASY	1
110112820	TY WRAP BUNDLE	1
466391090S1	HARN ASSY, J2	1
466391120S1	HARNESS ASSY., CAB HARNESS 1CH J1 A/S	1
466391130S1	HARNESS ASSY., SPRAYER HARN. 1CH A/S	1
110011351	LAND MANGER OPERATORS MANUAL I/II	1
110011090	INST INSTR LAND MAN	1

LM1PL

Component	Item Description	Qty
466390025S1	CSL[CE] LAND MANAGER	1
466390910S1	MTG BRACKET KIT LM	1
466050030	MASTER SW MODULE ASY	1
110112820	TY WRAP BUNDLE	1
466391090S1	HARN ASSY, J2	1
466391003S1	CAB HARN J1 LONG	1
466391030S1	IMP HARN 1 CHANNEL	1
110011351	LAND MANGER OPERATORS MANUAL I/II	1
110011090	INST INSTR LAND MAN	1

LM1PS

Component	Item Description	Qty
466390025S1	CSL[CE] LAND MANAGER	1
466390910S1	MTG BRACKET KIT LM	1
466050030	MASTER SW MODULE ASY	1
110112820	TY WRAP BUNDLE	1
466391090S1	HARN ASSY, J2	1
466391000S1	CAB HARN J1	1
466391030S1	IMP HARN 1 CHANNEL	1
110011351	LAND MANGER OPERATORS MANUAL I/II	1
110011090	INST INSTR LAND MAN	1

LM1T

Component	Item Description	Qty
466390025S1	CSL[CE]LAND MANAGER	1
466390910S1	MTG BRACKET KIT LM	1
466050030	MASTER SW MODULE ASY	1
110112820	TY WRAP BUNDLE	1
466391090S1	HARN ASSY, J2	1
466391081S1	HARN ASY CNTL SYS J1	1
110011351	LAND MANGER OPERATORS MANUAL I/II	1
110011090	INST INSTR LAND MAN	1

LM2 Kits

LM2PL

Component	Item Description	Qty
466390026S1	CSL[CE] LAND MAN II	1
466390910S1	MTG BRACKET KIT LM	1
466050030	MASTER SW MODULE ASY	1
110112820	TY WRAP BUNDLE	1
466391090S1	HARN ASSY, J2	1
466391003S1	CAB HARN J1 LONG	1
466391031S1	IMP HARN 2 CHANNEL	1
110011351	LAND MANGER OPERATORS MANUAL I/II	1
110011090	INST INSTR LAND MAN	1

LM2PS

Component	Item Description	Qty
466390026S1	CSL[CE] LAND MAN II	1
466390910S1	MTG BRACKET KIT LM	1
466050030	MASTER SW MODULE ASY	1
110112820	TY WRAP BUNDLE	1
466391090S1	HARN ASSY, J2	1
466391000S1	CAB HARN J1	1
466391031S1	IMP HARN 2 CHANNEL	1
110011351	LAND MANGER OPERATORS MANUAL I/II	1
110011090	INST INSTR LAND MAN	1

LM2T

Component	Item Description	Qty
466390026S1	CSL[CE] LAND MAN II	1
466390910S1	MTG BRACKET KIT LM	1
466050030	MASTER SW MODULE ASY	1
110112820	TY WRAP BUNDLE	1
466391090S1	HARN ASSY, J2	1
466391210S1	HARN ASY CNTL SYS J1	1
466391051S1	HARNESS,POWER	1
110011351	LAND MANGER OPERATORS MANUAL I/II	1
110011090	INST INSTR LAND MAN	1

LM1/CCS RETRO

Component	Item Description	Qty
466390025S1	CONSOLE LM1	1
466391101S1	RETRO HARNESS	1
466050030	SWITCH MODULE	1
466390910S1	MOUNTING BRACKET	1
466390150S1	ACT POWER HARNESS	1
110011090	INSTALLATION INSTRUCTION	1
110011351A	MANUAL	1

LMSE/Press/Flow/NH3 Kits

LMSE

LMSEP

Component	Item Description	Qty
466390029S1	CSL[CE] LAND MANAGER SE	1
466390910S1	MTG BRACKET KIT LM	1
466050030	MASTER SW MODULE ASY	1
110112820	TY WRAP BUNDLE	1
466391260S1	HARNESS ASSY ADAPT, LAND MANAGER SE	1
457901892	HARNESS, MAIN, CCS100	1
457901891S1	HARNESS, IMPLEMENT	1
466391050S1	HARN, ACT PWR	1
110011248	LAND MANAGER SE VERS. 1.5SW MANUAL	1
110011197	INSTALLATION INSTR LAND MANAGER SE	1

LMSET

Component	Item Description	Qty
466390029S1	CSL[CE] LAND MANAGER SE	1
466390910S1	MTG BRACKET KIT LM	1
466050030	MASTER SW MODULE ASY	1
110112820	TY WRAP BUNDLE	1
466391260S1	HARNESS ASSY ADAPT, LAND MANAGER SE	1
464360210A	HARN CCS MAIN TRUCK	1
110011248	LAND MANAGER SE VERS. 1.5SW MANUAL	1
110011197	INSTALLATION INSTR LAND MANAGER SE	1

PRESSURE

L2P

Component	Item Description	Qty
467095150	VALVE & ACTUATOR 2"	1
465700010	XDUCER, 100 PSI CCS	1
110040228	HARDWARE PKG-DJSC	1

L3P

Component	Item Description	Qty
467095170	VALVE & ACTUATOR 3"	1
465700010	XDUCER, 100 PSI CCS	1

LSP

Component	Item Description	Qty
HV0PT1	HYDRAUL. VALVE OPTION SET, GRAN. VALVES	1
464360030A	VALVE ACTUATOR DRIVER	1
465700010	XDUCER, 100 PSI CCS	1

FLOW

L2POLYF

Component	Item Description	Qty
PM00370048S1	FLOW METER/SNSR, 2", 19.0-198 GPM	1
467095150	VALVE & ACTUATOR 2"	1

NH3

CONTNH3KIT

Component	Item Description	Qty
457903320B	SUPER FLOW ASSY	1
457903380	BALL VALVE, CONTROL	1
457903390	BRACKET, ACTUATOR MOUNT	1
457901610S1	FLOW METER, CCS100	1
457903310S1	HARDWARE KIT CONT	1
110011362A	MANUAL, NH3 OPERATING	1
110011326	CONT. INSTALL INSTRUCTIONS	1
457904000	COUPLER KIT TO 1 1/4 VALVE	1

Land Manager® Parts & Accessories



Land Manager® Switch Module

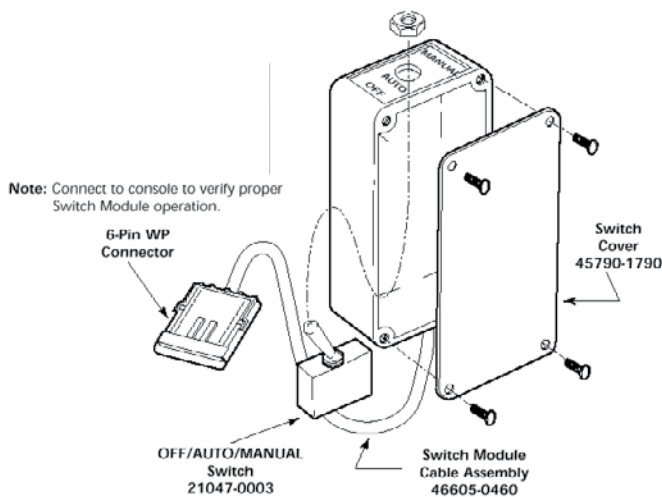

Connector Pin Numbers		
Pin No.	Color	Function/Voltage
A	Black	Ground (0V)
B	White	Manual (0-12V)
C	Red	-12V
D	Green	Auto (0-12V)

Console	
Part Number	Description
46639-0025S1	Land Manager I Console
46639-0026S1	Land Manager II Console
46639-0029S1	Land Manager SE Console
Harness, Adapters, Hardware	
43940-0024	Ground Speed Sensor Extension 10 ft.
45790-1810	Sensor Extension 15 ft.
45790-1811	Sensor Extension 30 ft.
45790-1820	Valve Extension 15 ft.
45790-1891S1	LMSE Implement Harness
45790-1892	LMSE Main Harness (requires 46639-1260S1)
45790-2770S1	LMSE Main Harness Extension 20 ft.
46350-0090	Hall Effect Extension (Fan RPM) 20 ft.
46350-0120	Hall Effect to Radar Extension 15.5 ft.
46436-0210A	LM Truck Harness (required 46639-1260S1)
46605-0030	Land Manager Switch Module
46639-0970S1	Land Manager Switch Module Bracket
46639-0910S1	Land Manager Mounting Bracket
46639-1000S1	Land Manager Main Harness, short (1 channel)
46639-1003S1	Land Manager Main Harness, long (1 channel)
46639-1030S1	Land Manager Implement Harness (1 channel)
46639-1031S1	Land Manager Implement Harness (2 channel)
46639-1050S1	Actuator Power Harness
46639-1051S1	Actuator Power Harness (2 channel)
46639-1081S1	Truck Harness (1 channel)
46639-1090S1	Land Manager Power Harness (RS232)
46639-1101S1	LM to CCS Adapter Harness
46639-1120S1	LM European J1 Cab Harness
46639-1130S1	LM European Sprayer Implement Harness
46639-1140S1	LM European Planter/Granular Implement Harness
46639-1150S1	LM European Speed & Area Implement Harness
46639-1210S1	Truck Harness (2 channel)
46639-1220S1	Main Harness Extension 25 ft.
46639-1260S1	LMSE to CCS Adapter Harness
Switch Module	
46605-0030	LM Switch Module
46639-0970S1	LM Switch Module Bracket

Single Thermal Transfer Unit

The Single Thermal Transfer Unit is discontinued; however some of the component parts are available.

To ensure the highest possible flow rates, applicator plumbing must be sized properly.

LBS/HR	Plumbing Size
0-3600	1 in. feed line and breakaway
3600-6800	1 1/4 in. feed line and breakaway
6800-up	1 1/2 in. feed line and breakaway



Single Thermal Transfer Unit-Discontinued

Part Number	Description
20648-0004	Elbow 1" x 1.25", Sch 80
20651-0006	Nipple 1.25" x 4" Sch 80
45790-1230	Flow Meter Flange
20648-0002	Elbow 1.25" x 1.25", Sch 80
21990-0004	Nipple 3/4" x 4", Sch 80
20648-0005	Elbow 3/4" x 1" Sch 80
45790-3200	NH3 Hose
45790-2500	TTU
45790-1260	Pressure Relieve Valves 250 psi

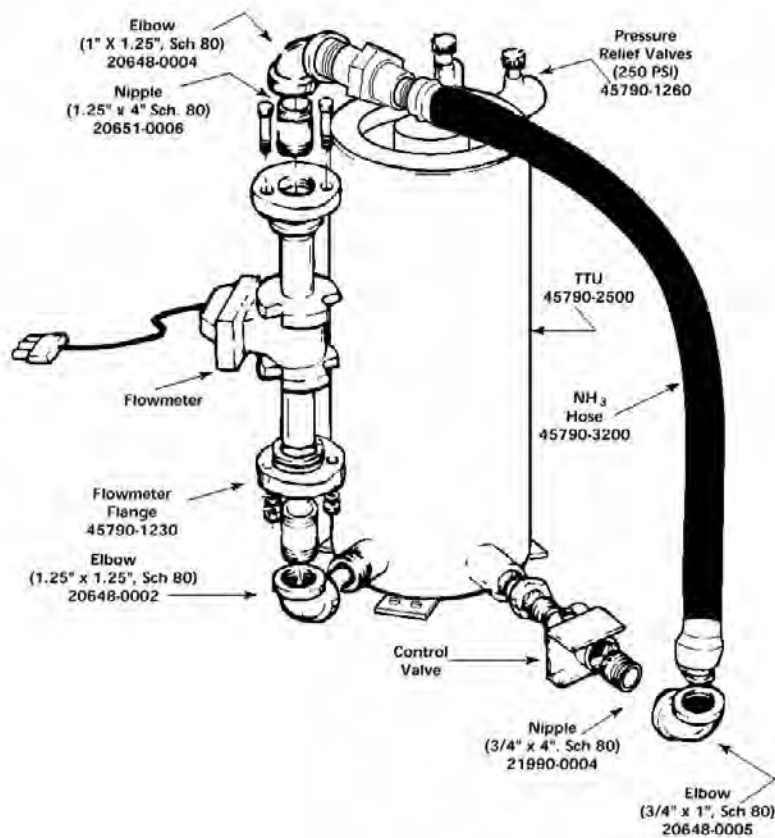

Liquid Pressure



Connector Pin Numbers ID		
Pin No.	Color	Function/Voltage
A	Red	+12V
B	Black	Ground
C	Green	(Pq) Signal (0-5)

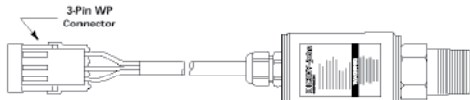

Liquid Pressure

- Measures 0-650 psi liquid pressure
- Can be used as alternative to Flow Meter in Land Manager® Liquid Sprayer Control Systems
- Reads liquid pressure at nozzle on spray bar
- Prevents over-application caused by single nozzle clogs

Part Number	Description
46570-0010	Pressure Sensor 0-100 psi
46570-0020	Pressure Sensor 0-650 psi
46570-0040	Pressure Sensor 0-225 psi
46570-0070	Pressure Sensor 0-300 psi

Hydraulic Servo



Use with Hydraulic Valve Driver Module 46436-0030A

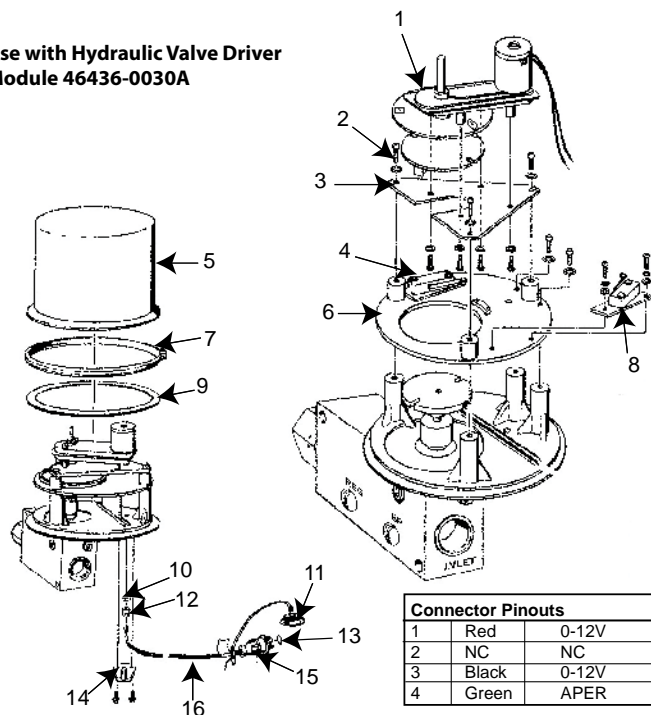

Connector Pinouts		
Pin No.	Color	Function/Voltage
1	Red	0-12V
2	NC	NC
3	Black	0-12V
4	Green	APER

Single Flow Servo

Item	Part Number	Description
1	44506-0001	Motor and Coupling (NOT AVAILABLE)
2	45714-0170	Center Coupling
3	45714-0180	Mounting Plate
4	45675-4023	Switch Assembly (black)
5	42282-0002	Valve Cover
6	45714-0120	Center Plate
7	21034-0002	Clamp
8	45675-4022	Switch Assembly (red)
9	42148-0004	Seal
10	21028-0023	O-ring
11	42147-0001	Dust Cover
12	44313-0001	Retainer
13	21093-0001	Seal Ring
14	44316-0001	Clamp
15	11059-0008	Connector Kit
16	43940-0021	Cable complete 10 ft.
	43940-0022	Cable complete 20 ft.
	43940-0023	Cable complete 30 ft.

Complete motor/actuator assembly for hydraulic servo valve use replacement parts:

- 46709-5360 Actuator only (Plugs into the harness direct with 6-pin connector. Old valve driver not required).
- 46709-8040 Hardware Mounting Kit

The system must be in operation to make adjustments. Both adjustments are located under the center plate.

CAUTION: Be cautious to not overspeed the hydraulic motor.

Adjustment 1 (To eliminate creep)

1. Loosen the Allen head screw (large) in the coupling collar.
2. Using pliers, rotate the valve stem until creep stops to establish a closed position.
3. Re-tighten the collar.

Adjustment 2 (Adjust maximum flow rate GPM)

1. Loosen the small Allen head screw in the orifice adjustment collar.
2. Using pliers, turn the orifice adjustment collar counterclockwise to increase flow; clockwise to decrease flow.
3. Re-tighten orifice collar screw.

Continental



Continental Superflow

**Limited availability
Please call to verify if in-stock**

Features:

- Allows faster runs at lower tank pressures
- Attain flow rates up to 9,600 lb./hr.
- Standard 1 1/4 in. plumbing
- Compatible with N-Serve nitrogen stabilizer
- Interchangeable orificed hose barbs for constant 2% or less vapor bleed off

To determine exchanger kit and valve size use the following formula:

Applicator width X speed X application rate (gpa) X 0.1212

Example:

42.5 ft. X 6 mph X 200 lbs. NH3 X 0.1212 = 6,181 lbs./hr.

NH3 Kit Anhydrous Ammonia Flow Rate Chart

Heat Exchanger Kit

Maximum Flow Rate

Valve Size

Continental Superflow

9,600 lbs./hr.

1 1/4 in.

Selecting a NH3 Heat Exchanger Kit requires:

- Width in feet of the anhydrous tool bar
- Maximum ground speed (mph) the tractor will pull the tool bar
- Maximum application rate of NH3 per acre to be applied

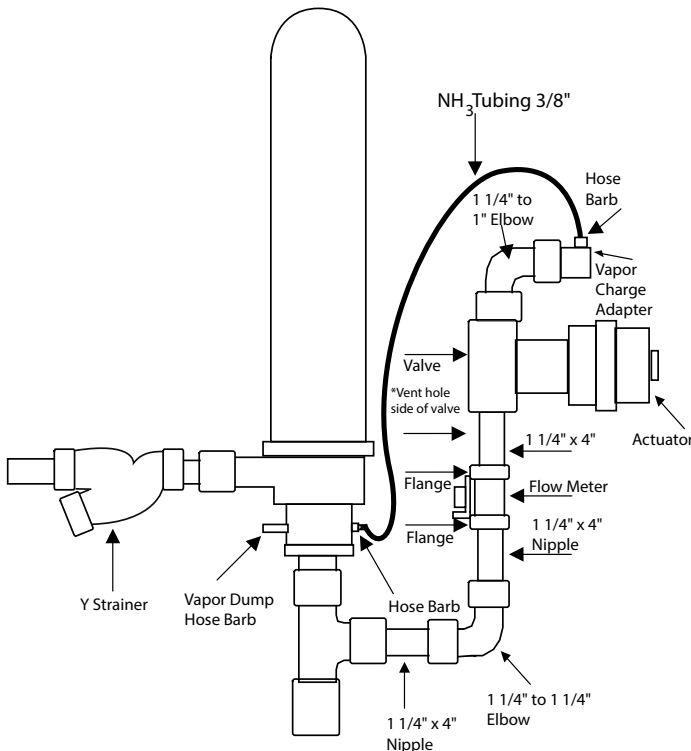

Part Number	Description
CONTNH3KIT	NH3 Kit Continental with 457903380 1 1/4 in. Ball Valve and 467095060 Actuator (9600 lbs/hr)
46709-5060	Actuator 1 1/4 in. (requires 45790-4000)
46709-6040	NH3 Section Shutoff Control Valve
45790-4000	Hardware Kit Mounting Bracket and Coupler
45790-1610S1	Liquid Flow Meter (Paddle Wheel)

Liquid Flow Meter (Paddle Wheel) Diagram

45790-1610S1

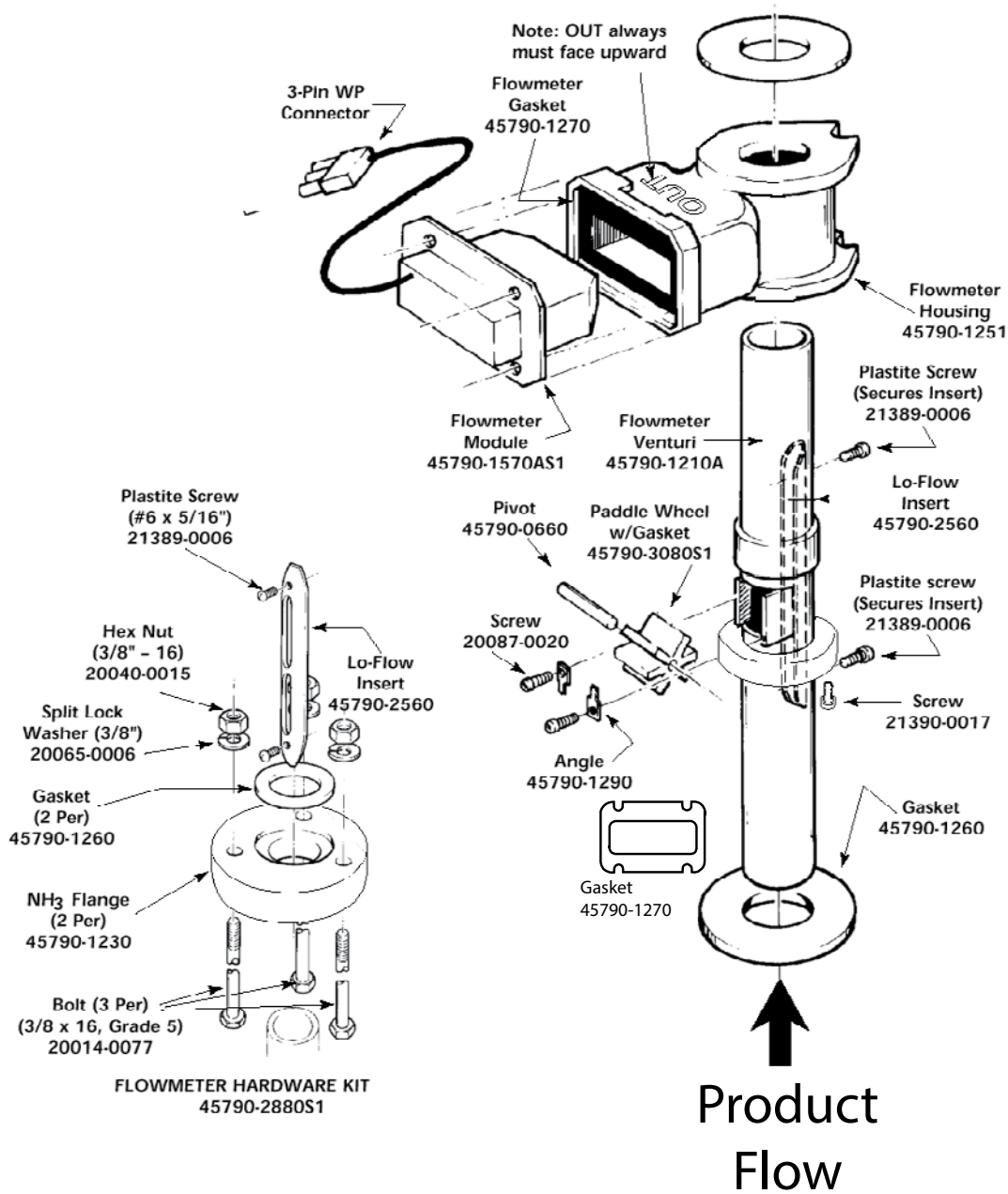

Poly Flow Meters

Nylon Parts

Flow Meter Parts (Nylon)	
Part Number	Description
PM20005432	Coupling Nut 1.5 in.
PM29300725S1	Turbine 0.5 in.
PM29301899S1	Axle and Bearings 0.5 in.
PM30005132	Coupling Nut 2 in.
PM30301125S1	Turbine .75 in.
PM30304999S1	Sensor only (Poly Flow Meter)
PM30305099S1	Axle and Bearing .75 in.
PM31300925S1	Turbine 1 in.
PM31303199S1	Axle and Bearing 1 in.
PM32300825S1	Turbine 2 in.
PM32302099S1	Axle and Bearings 1.5 in. and 2 in.
PM32302099S1	Axle and Bearings 2 in. and 1.5 in.
PM33302632	Flange with o-ring 3 in.
PM33302732	Flange without o-ring 3 in.
PM34300325S1	Turbine 1.5 in.
PM35300532	Flange with o-ring 4 in.
PM35300632	Flange without o-ring 4 in.
PM65401732	Coupling Nut 0.5 in. (also fit .75 in flow meter)
PM65403132	Hose Barb 0.5 in. (also fits .75 in. flow meter)
PM67401332	Coupling Nut 1 in.
PM67402432	Hose Barb 1 in.
PM80001432	O-ring Viton 0.5 in. (also fits .75 in. flow meter)
PM80002232	O-ring Viton 2 in.
PM80004832	O-ring Viton 1.5 in.
PM80005432	O-ring Viton 1 in.
PM82406532	Hose Barb 2 in.
PM82416432	Hose Barb 1.5 in.

Connectors

Weather Pack

Socket contacts, pin contacts, and seals are the same part numbers for all Weather Pack plugs and receptacles. Weather Pack connector kits and accessories page 156.

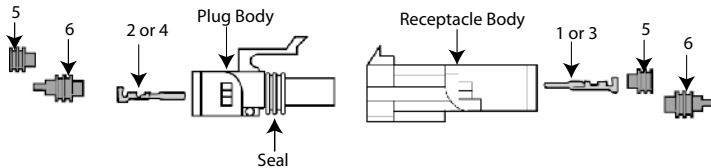

Item	Part Number	Description
1	21896-0001	Pin Contact 18-20 ga.
2	21896-0002	Socket Contact 18-20 ga.
3	21896-0003	Pin Contact 14-16 ga.
4	21896-0004	Socket Contact 14-16 ga.
5	21897-0001	Seal (hole through center) (sealed around wire)
6	21897-0002	Seal (solid center) (seals unused hole)
	21897-0004	Green Plug

AMP

Socket contacts and pin contacts are the same part numbers for all AMP CPC plugs and receptacles. AMP connector kits and accessories page 158.

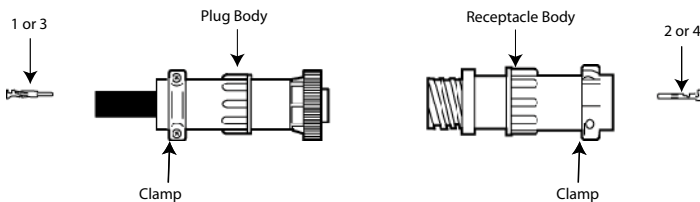

Item	Part Number	Description
1	21089-0001	Pin Contact (20-24 ga.)
2	21088-0001	Socket Contact (20-24 ga.)
3	21089-0002	Pin Contact (14-18 ga.)
4	21088-0002	Socket Contact (14-18 ga.)



21894-0007



21894-0008



21894-0009



21895-0007

Metri-Pack

Part Number	Description
21894-0007	2 cavity, Metri Pack, Sealed, Female Connector
21894-0008	2 cavity, Metri Pack, Sealed, Male Connector
21894-0009	2 cavity, Metri Pack, Sealed, Female Connector
21895-0007	2 cavity, Receptacle Body

Connectors & Kits

Part Number	Description
46682-0770S1	1-pin Connector Kit
21894-0001	Plug Body (male)
21896-0002	Socket Contact (18-20 ga.)
21896-0004	Socket Contact (14-16 ga.)
21897-0001	Seal, hole (18-20 ga.)
21897-0002	Seal, hole (14-16 ga.)



Part Number	Description
46627-0250	2-pin Connector Kit
21894-0002	Plug Body (male)
21896-0002	Socket Contact (18-20 ga.)
21896-0004	Socket Contact (14-16 ga.)
21897-0001	Seal, hole (18-20 ga.)
21897-0002	Seal, hole (14-16 ga.)



Part Number	Description
46627-0270	3-pin Connector Kit
21894-0003	Plug Body (male)
21896-0002	Socket Contact (18-20 ga.)
21896-0004	Socket Contact (14-16 ga.)
21897-0001	Seal, hole (18-20 ga.)
21897-0002	Seal, hole (14-16 ga.)



Part Number	Description
46627-0710	4-pin Connect Kit, Flat
21894-0004	Plug Body (male)
21896-0002	Socket Contact (18-20 ga.)
21896-0004	Socket Contact (14-16 ga.)
21897-0001	Seal, hole (18-20 ga.)
21897-0002	Seal, hole (14-16 ga.)



Part Number	Description
46627-0290	4-pin Connector Kit, Square
21894-0005	Plug Body (male)
21896-0002	Socket Contact (18-20 ga.)
21896-0004	Socket Contact (14-16 ga.)
21897-0001	Seal, hole (18-20 ga.)
21897-0002	Seal, hole (14-16 ga.)



Part Number	Description
46627-0730	6-pin Connector Kit, Slat
21894-0006	Plug Body (male)
21896-0002	Socket Contact (18-20 ga.)
21896-0004	Socket Contact (14-16 ga.)
21897-0001	Seal, hole (18-20 ga.)
21897-0002	Seal, hole (14-16 ga.)



Weather Pack

Part Number	Description
46682-0770S1	1-pin Receptacle Kit
21895-0001	Receptacle Body (female)
21896-0001	Pin Contact (18-20 ga.)
21896-0003	Pin Contact (14-16 ga.)
21897-0001	Seal, hole (18-20 ga.)
21897-0002	Seal, hole (14-16 ga.)

Part Number	Description
46627-0240	2-pin Receptacle Kit
21895-0002	Receptacle Body (female)
21896-0001	Pin Contact (18-20 ga.)
21896-0003	Pin Contact (14-16 ga.)
21897-0001	Seal, hole (18-20 ga.)
21897-0002	Seal, hole (14-16 ga.)

Part Number	Description
46627-0260	3-pin Receptacle Kit
21895-0003	Receptacle Body (female)
21896-0001	Pin Contact (18-20 ga.)
21896-0003	Pin Contact (14-16 ga.)
21897-0001	Seal, hole (18-20 ga.)
21897-0002	Seal, hole (14-16 ga.)

Part Number	Description
46627-0720	4-pin Receptacle Kit, Flat
21895-0004	Receptacle Body (female)
21896-0001	Pin Contact (18-20 ga.)
21896-0003	Pin Contact (14-16 ga.)
21897-0001	Seal, hole (18-20 ga.)
21897-0002	Seal, hole (14-16 ga.)

Part Number	Description
46627-0280	4-pin Receptacle Kit, Square
21895-0005	Receptacle Body (female)
21896-0001	Pin Contact (18-20 ga.)
21896-0003	Pin Contact (14-16 ga.)
21897-0001	Seal, hole (18-20 ga.)
21897-0002	Seal, hole (14-16 ga.)

Part Number	Description
46627-0740	6-pin Receptacle Kit, Flat
21895-0006	Receptacle Body (female)
21896-0001	Pin Contact (18-20 ga.)
21896-0003	Pin Contact (14-16 ga.)
21897-0001	Seal, hole (18-20 ga.)
21897-0002	Seal, hole (14-16 ga.)

Dust Cap Plugs & Receptacles

Weather Pack



45790-2860
1-pin Dust Cap Plug



46695-0490
1-pin Dust Cap Receptacle



46421-1320
2-pin Dust Cap Plug



46421-1330
2-pin Dust Cap Receptacle



46421-1090
3-pin Dust Cap Plug



46421-1100
3-pin Dust Cap Receptacle



46421-1110
4-pin Square Dust Cap Plug



46421-1120
4-pin Square Dust Cap Receptacle



46421-1610
4-pin Straight Dust Cap Plug



46421-1600
4-pin Straight Dust Cap Receptacle



46421-1340
6-pin Dust Cap Plug



46421-1590
6-pin Dust Cap Receptacle

Connectors & Kits

AMP

Part Number	Description
11059-0007	4-pin w/Locking Ring Kit
21090-0001	Plug Body
21090-0004	Connector Body
21088-0001	Socket Contact (20-24 ga.)
21088-0002	Socket Contact (14-18 ga.)
21089-0001	Pin Contact (20-24 ga.)
21089-0002	Pin Contact (14-18 ga.)
21092-0001	Clamp

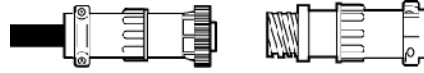

Part Number	Description
11059-0009	9-pin with Locking Ring Kit
21090-0006	Connector Body
21088-0001	Socket Contact (20-24 ga.)
21088-0002	Socket Contact (14-18 ga.)
21092-0004	Clamp

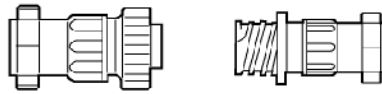

Part Number	Description
11059-0011	14-pin with Locking Ring Kit
21090-0003	Connector Body
21088-0001	Socket Contact (20-24 ga.)
21088-0002	Socket Contact (14-18 ga.)
21092-0007	Clamp



Part Number	Description
11059-0013	16-pin with Locking Ring Kit
21090-0002	Connector Body
21088-0001	Socket Contact (20-24 ga.)
21088-0002	Socket Contact (14-18 ga.)
21092-0007	Clamp



Part Number	Description
11059-0005	37-pin with Locking Ring Kit
21090-0005	Connector Body
21088-0001	Socket Contact (20-24 ga.)
21088-0002	Socket Contact (14-18 ga.)
21092-0003	Clamp

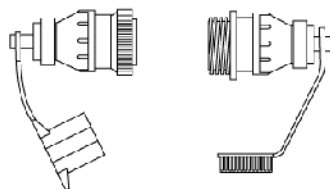

Part Number	Description
11059-0008	4-pin without Locking Ring Kit
21091-0001	Connector Body
21091-0003	Connector Body
21088-0001	Socket Contact (20-24 ga.)
21088-0002	Socket Contact (14-18 ga.)
21089-0001	Pin Contact (20-24 ga.)
21089-0002	Pin Contact (14-18 ga.)
21092-0001	Clamp

Part Number	Description
11059-0010	6-pin without Locking Ring Kit
21091-0006	Connector Body
21089-0001	Pin Contact (20-24 ga.)
21089-0002	Pin Contact (14-18 ga.)
21092-0004	Clamp

Part Number	Description
11059-0012	14-pin without Locking Ring Kit
21091-0004	Connector Body
21089-0001	Pin Contact (20-24 ga.)
21089-0002	Pin Contact (14-18 ga.)
21092-0007	Clamp

Part Number	Description
11059-0014	16-pin without Locking Ring Kit
21091-0002	Connector Body
21089-0001	Pin Contact (20-24 ga.)
21089-0002	Pin Contact (14-18 ga.)
21092-0007	Clamp

Part Number	Description
11059-0016	37-pin without Locking Ring Kit
21101-0005	Connector Body
21089-0001	Pin Contact (20-24 ga.)
21089-0002	Pin Contact (14-18 ga.)
21092-0003	Clamp

Specifications subject to change without notice.

DICKY-john®
5200 Dickey John Road
Auburn, IL 62615 USA
Toll Free: +1-800-637-3302
Phone: +1-217-438-3371
E-Mail: info@dickey-john.com
www.dickey-john.com

WORLD LEADER

Precision Agriculture

When you take a need, add inspiration,
ingenuity and develop a quality result,
you get market-leading technology in
the Agriculture Industry



5200 Dickey John Road
Auburn, IL 62615
www.dickey-john.com

+1 217-438-3371
+1 217-438-6012 fax
©2022 DICKY-john

DICKY-john and the DICKY-john Logo are
registered trademarks of TSI Incorporated in the
United States and may be protected under other
country's trademark registrations.

5001785 Rev F